

DICOM CONFORMANCE STATEMENT**FOR****X-RAY CT SCANNER****Aquilion™ , Alexion™ , Astelion™****Aquilion™ PRIME, Aquilion ONE™****V6.0 OR LATER****(TSX-101A,TSX-301A,TSX-301B,TSX-301C,****TSX-302A,TSX-201A,TSX-032A,TSX-033A,****TSX-034A,TSX-303A)****CANON MEDICAL SYSTEMS CORPORATION**

Trademarks

Astelion, Alexion, Aquilion and Aquilion ONE are trademark of Canon Medical Systems Corporation.

This document may include trademarks or registered trademarks of other companies.

IMPORTANT!

- (1) No part of this document may be copied or reprinted, in whole or in part, without written permission.
- (2) The contents of this document are subject to change without prior notice and without our legal obligation.

1. CONFORMANCE STATEMENT OVERVIEW

Table 1-1 provides an overview of the network services supported by Astelion™, Alexion™, Aquilion™, Aquilion™ PRIME and Aquilion ONE™.

**Table 1-1
NETWORK SERVICES**

SOP Classes	User of Service (SCU)	Provider of Service (SCP)
Transfer		
CT Image Storage	Yes	Yes*1 (COT-30D)
Secondary Capture Image Storage	Yes	Yes*1 (COT-30D)
Standalone Curve Storage	Yes	Yes*1 (COT-30D)
Enhanced CT Image Storage	Yes*2 (COT-45A)	Yes*2 (COT-45A)
Grayscale Softcopy Presentation State Storage	Yes	Yes*1 (COT-30D)
Enhanced SR Storage	Yes	Yes*1 (COT-30D)
X-Ray Radiation Dose SR Storage	Yes	Yes*1 (COT-30D)
Segmentation Storage	Yes	Yes
Storage Commitment		
Storage Commitment Push Model	Yes*1 (COT-41D)	No
Query/Retrieve		
Patient Root Q/R Information Model – Find	No	Yes*1 (COT-34D)
Patient Root Q/R Information Model – Move	No	Yes*1 (COT-34D)
Study Root Q/R Information Model – Find	Yes*1 (COT-35D)	Yes*1 (COT-34D)
Study Root Q/R Information Model – Move	Yes*1 (COT-35D)	Yes*1 (COT-34D)
Patient/Study Only Information Model – Find	No	Yes*1 (COT-34D)
Patient/Study Only Information Model – Move	No	Yes*1 (COT-34D)
Workflow Management		
Modality Worklist Information Model – Find	Yes*1 (COT-32D)	No
Modality Performed Procedure Step	Yes*1 (COT-33D)	No
Modality Performed Procedure Step Retrieve	Yes*1 (COT-33D)	No
Print Management		
Basic Grayscale Print Management	Yes	No
Basic Color Print Management	Yes	No

*1:Option

*2:Option for Astelion™, Alexion™, Aquilion™, Standard for Aquilion™ PRIME, Aquilion ONE™ (COT-XXX):Option Model Name

Table 1-2 provides an overview of the Media Storage Application Profiles supported by Astelion™, Alexion™, Aquilion™, Aquilion™ PRIME and Aquilion ONE™.

**Table 1-2
MEDIA SERVICES**

Media Storage Application Profile	Write Files (FSC or FSU)	Read Files (FSR)
Compact Disk – Recordable		
CT and MR Image CD-R	Yes	No*
General Purpose CD-R	Yes	Yes
Dedicated CT CD-R	Yes	Yes
DVD - Recordable		
General Purpose DVD-R	Yes	Yes
Dedicated CT DVD-R	Yes	Yes
DVD - Random Access		
CT and MR Image DVD-RAM	Yes	No*
General Purpose DVD-RAM	Yes	Yes
Dedicated CT DVD-RAM	Yes	Yes

*: The system supports some parts of the CT and MR Image CD-R and the CT and MR Image DVD-RAM Application Profile as an FSR. Supported SOP Classes and Transfer Syntaxes are listed below.

**Table 1-3
SUPPORTED IODS, SOP CLASSES AND TRANSFER SYNTAXES**

Information Object Definition	SOP Class UID	Transfer Syntax	Transfer Syntax UID
Media Storage Directory Storage	1.2.840.10008.1.3.10	Explicit VR Little Endian Uncompressed	1.2.840.10008.1.2.1
CT Image Storage	1.2.840.10008.5.1.4.1.1.2	Explicit VR Little Endian Uncompressed	1.2.840.10008.1.2.1
CT Image Storage	1.2.840.10008.5.1.4.1.1.2	JPEG Lossless, Non-Hierarchical, First-Order Prediction (Process 14 [Selection Value 1])	1.2.840.10008.1.2.4.70
Secondary Capture Image Storage (Grayscale)	1.2.840.10008.5.1.4.1.1.7	Explicit VR Little Endian Uncompressed	1.2.840.10008.1.2.1
Secondary Capture Image Storage (Grayscale)	1.2.840.10008.5.1.4.1.1.7	JPEG Lossless, Non-Hierarchical, First-Order Prediction (Process 14 [Selection Value 1])	1.2.840.10008.1.2.4.70

2. TABLE OF CONTENTS

1.	CONFORMANCE STATEMENT OVERVIEW	i
2.	TABLE OF CONTENTS	a
3.	INTRODUCTION	1
3.1	REVISION HISTORY	1
3.2	AUDIENCE	1
3.3	REMARKS	1
3.4	DEFINITIONS, TERMS AND ABBREVIATIONS	2
3.5	REFERENCES	2
4.	NETWORKING	3
4.1	IMPLEMENTATION MODEL	3
4.1.1	Application Data Flow	3
4.1.2	Functional Definition of AEs	5
4.1.3	Sequencing of Real-World Activities	6
4.2	AE SPECIFICATIONS	8
4.2.1	Storage SCU AE Specification	8
4.2.2	Storage Commitment SCU AE Specification	14
4.2.3	Q/R SCP AE Specification	20
4.2.4	MWM SCU AE Specification	30
4.2.5	MPPS SCU AE Specification	37
4.2.6	Q/R SCU AE Specification	44
4.2.7	Storage SCP AE Specification	51
4.2.8	Print SCU AE Specification	57
4.3	NETWORK INTERFACES	70
4.3.1	Physical Network Interface	70
4.3.2	Additional Protocols	70
4.4	CONFIGURATION	70
4.4.1	AE Title/Presentation Address Mapping	70
4.4.2	Parameters	71
5.	MEDIA INTERCHANGE	75
5.1	IMPLEMENTATION MODEL	75
5.1.1	Application Data Flow	75
5.1.2	Functional Definition of AEs	75
5.1.3	Sequencing of Real-World Activities	77
5.1.4	File Meta Information for Implementation Class and Version	78
5.2	AE SPECIFICATIONS	79
5.2.1	Offline-Media AE Specification	79
5.3	AUGMENTED AND PRIVATE APPLICATION PROFILES	90
5.3.1	Augmented Application Profiles	90
5.3.2	Private Application Profiles	90
5.4	MEDIA CONFIGURATION	93
6.	SUPPORT OF CHARACTER SETS	94
7.	SECURITY	95

8.	ANNEXES	96
8.1	IOD CONTENTS	96
8.1.1	Created SOP Instances	96
8.1.2	Usage of Attributes from received IOD's	147
8.1.3	Attribute Mapping	147
8.1.4	Coerced/Modified Fields	147
8.1.5	STRUCTURED REPORT DOCUMENT INFORMATIONS	148
8.2	DATA DICTIONARY OF PRIVATE ATTRIBUTES	156
8.3	CONTROLLED TERMINOLOGY AND TEMPLATES	158
8.4	GRAYSCALE IMAGE CONSISTENCY	158
8.5	STANDARD EXTENDED/SPECIALIZED/PRIVATE SOP CLASSES	159
8.5.1	Standard Extended SOP Class - CT Image Storage.....	159
8.5.2	Private SOP Class - Toshiba CT Non-Image Storage	160
8.6	PRIVATE TRANSFER SYNTAXES	163

3. INTRODUCTION

3.1 REVISION HISTORY

REV.	Date of Issue	Author	Description
*	January 20, 2013	TMSC	First edition
A	February.3.2014	TMSC	Add system
B	January 20, 2015	TMSC	Add system
C	January 4, 2018	Canon Medical Systems	Change of company name

3.2 AUDIENCE

This document is intended for hospital staff, health system integrators, software designers or implementers. It is assumed that the reader has a working understanding of DICOM.

3.3 REMARKS

DICOM, by itself, does not guarantee interoperability. However, the Conformance Statement facilitates a first-level validation for interoperability between different applications supporting the same DICOM functionality.

This Conformance Statement is not intended to replace validation with other DICOM equipment to ensure proper exchange of information intended.

The scope of this Conformance Statement is to facilitate communication with Canon Medical Systems and other vendors' Medical equipment. The Conformance Statement should be read and understood in conjunction with the DICOM Standard [DICOM]. However, by itself it is not guaranteed to ensure the desired interoperability and a successful interconnectivity.

The user should be aware of the following important issues:

- The comparison of different conformance statements is the first step towards assessing interconnectivity between Canon Medical Systems and non- Canon Medical Systems equipment.
- Test procedures should be defined to validate the desired level of connectivity.
- The DICOM standard will evolve to meet the users' future requirements. Canon Medical Systems is actively involved in developing the standard further and therefore reserves the right to make changes to its products or to discontinue its delivery.

3.4 DEFINITIONS, TERMS AND ABBREVIATIONS

Definitions, terms and abbreviations used in this document are defined within the different parts of the DICOM standard.

Abbreviations and terms are as follows:

AE	Application Entity
AET	Application Entity Title
ASCE	Association Control Service Element
CD-R	Compact Disk Recordable
DIMSE	DICOM Message Service Element
DVD	A trademark of the DVD forum that is not an abbreviation
DVD-RAM	DVD-Random Access
FSC	File-Set Creator
FSU	File-Set Updater
FSR	File-Set Reader
IE	Information Entity
IOD	Information Object Definition
MPPS	Modality Performed Procedure Step
MPPSR	Modality Performed Procedure Step Retrieve
MSPS	Modality Scheduled Procedure Step
MWM	Modality Worklist Management
R	Required Key Attribute
O	Optional Key Attribute
PDU	Protocol Data Unit
SCU	Service Class User (DICOM client)
SCP	Service Class Provider (DICOM server)
SOP	Service-Object Pair
U	Unique Key Attribute
UID	Unique Identifier

3.5 REFERENCES

[DICOM] Digital Imaging and Communications in Medicine (DICOM), NEMA PS 3.1-3.18, 2004-2009

4. NETWORKING

4.1 IMPLEMENTATION MODEL

4.1.1 Application Data Flow

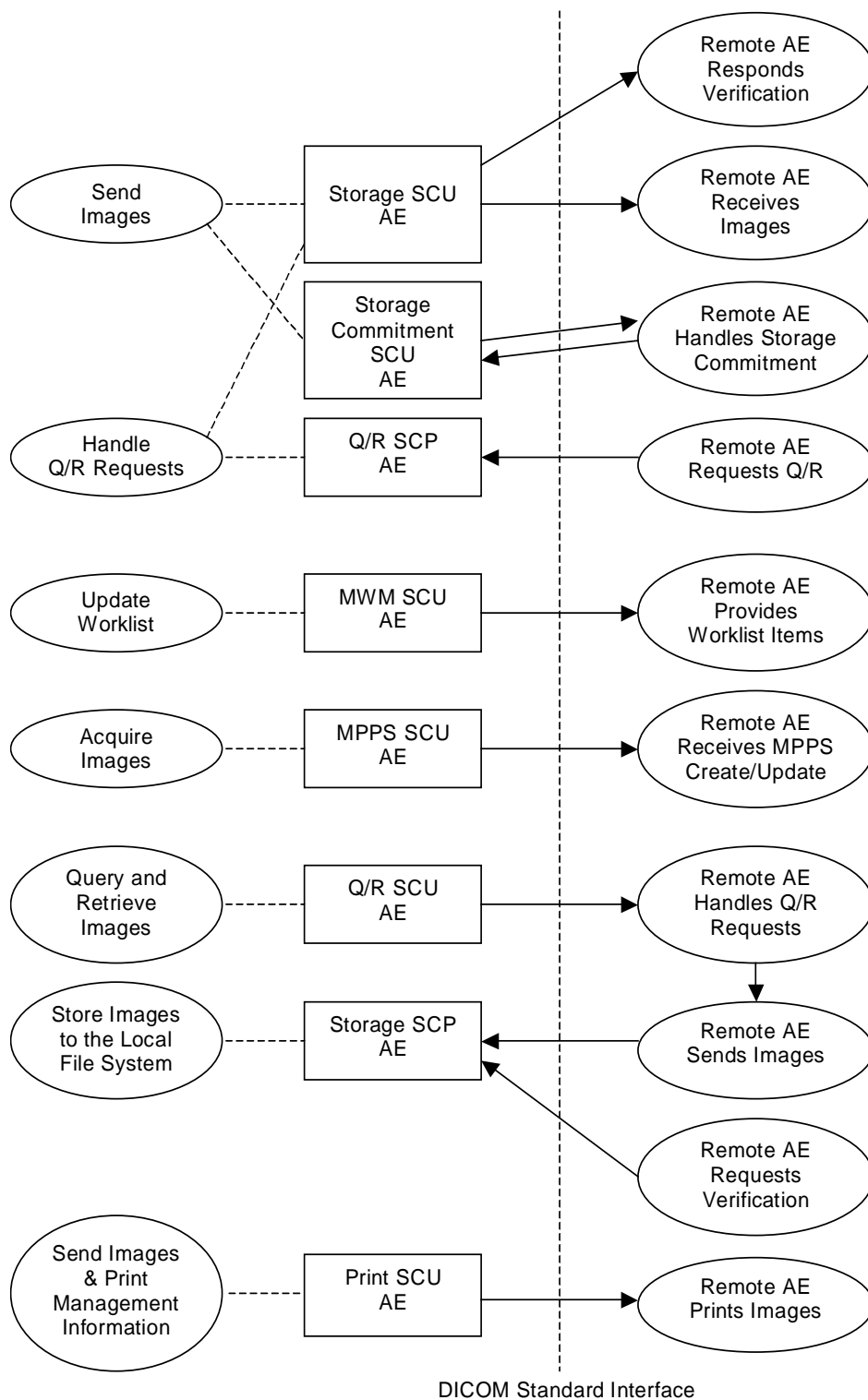

Figure 4.1-1
APPLICATION DATA FLOW DIAGRAM

- The Storage SCU AE sends images to a remote AE. It is associated with the local real-world activity “Send Images”. “Send Images” is performed upon user request for specific images selected. If the remote AE is configured as an archive device, the Storage SCU AE will send a storage commitment request to the Storage Commitment SCU AE. The Storage SCU AE can also issue C-ECHO requests as a Verification SCU.
- The Storage Commitment SCU AE will request Storage Commitment and if a commitment is successfully obtained will record this information in the local database.
- The Q/R SCP AE handles incoming query and retrieve requests issued by a remote AE. It is associated with the local real-world activity “Handle Q/R Requests”. “Handle Q/R Requests” handles retrieval requests by issuing a command to the Storage SCU AE to send the requested Images to the destination specified by the remote AE. The Q/R SCP AE functions as an SCP for C-FIND and C-MOVE requests.
- The MWM SCU AE receives Worklist information from a remote AE. It is associated with the local real-world activity “Update Worklist”. When the “Update Worklist” is performed the MWM SCU AE queries a remote AE for worklist items and provides the set of worklist items matching the query request. “Update Worklist” is performed as a result of an operator request.
- The MPPS SCU AE sends MPPS information to a remote AE. It is associated with the local real-world activity “Acquire Images”. When the “Acquire Images” is performed the MPPS SCU AE creates and updates Modality Performed Procedure Step instances managed by a remote AE. Acquisition of images will result in automated creation of an MPPS Instance. Completion of the MPPS is performed as the result of an operator action. If the remote AE is configured as an MPPSR SCP, the MPPS SCU AE can receive MPPSR information.
- The Q/R SCU AE queries a remote AE for lists of studies, series and images and retrieves selected studies, series or images. It is associated with the local real-world activity “Query and Retrieve Images”.
- The Storage SCP AE receives incoming images. It is associated with the local real-world activity “Store Images to the Local File System”. “Store Images to the Local File System” stores the received images to the local file system. The Storage SCP AE can also respond to C-ECHO requests as a Verification SCP.
- The Print SCU AE prints images on a remote AE (Printer). It is associated with the local real-world activity “Send Images & Print Management Information”. “Send Images & Print Management Information” creates a print-job within the print queue containing one or more virtual film sheets composed from images selected by the user.

4.1.2 Functional Definition of AEs

4.1.2.1 Functional Definition of Storage SCU AE

The existence of a send-job queue entry with associated network destination will activate the Storage SCU AE. An Association request is sent to the destination AE and upon successful negotiation of a Presentation Context the image transfer is started. If the image transfer fails, the Storage SCU AE will retry this send-job automatically. If the remote AE is configured as an archive device, the storage SCU AE will send a storage commitment request to the Storage Commitment SCU AE. The Storage SCU AE can also issue C-ECHO requests as a Verification SCU before the image transfer.

4.1.2.2 Functional Definition of Storage Commitment SCU AE

The Storage Commitment SCU AE will request Storage Commitment and if a commitment is successfully obtained will record this information in the local database.

4.1.2.3 Functional Definition of Q/R SCP AE

The Q/R SCP AE waits for another application to connect at the presentation address configured for its Application Entity Title. The Q/R SCP AE will accept Associations with Presentation Contexts for SOP Class of the Query/Retrieve Service Class. It will handle query and retrieve requests on these Presentation Contexts and respond with data objects with values corresponding to the contents of the local file system. When a retrieval request is received, the Q/R SCP AE issues a command to the Storage SCU AE to send the specified images to the destination.

4.1.2.4 Functional Definition of MWM SCU AE

The MWM SCU AE attempts to download a worklist from a remote node. If the MWM SCU AE establishes an Association to a remote AE, it will transfer patient's information and worklist items via the open Association. The results will be displayed in a separate list. The patient's information will be used for the patient registration.

4.1.2.5 Functional Definition of MPPS SCU AE

The MPPS SCU AE performs the creation of an MPPS Instance automatically whenever images are acquired. Further updates on the MPPS data can be performed automatically or interactively. If the remote AE is configured as an MPPSR SCP, the MPPS SCU AE can receive MPPSR information.

4.1.2.6 Functional Definition of Q/R SCU AE

The Q/R SCU AE is activated when the user selects a remote node to query and enters some key information, Patient's Name, Patient ID and/or Study Date. The user can select studies, series and images to be retrieved. The images will be received at the Storage SCP AE.

4.1.2.7 Functional Definition of Storage SCP AE

The Storage SCP AE waits for another application to connect at the presentation address configured for its Application Entity Title. The Storage SCP AE will accept Associations with Presentation Contexts for SOP Classes of the Verification and Storage Service Classes. Any images received on such Presentation Contexts will be stored to the local file system.

4.1.2.8 Functional Definition of Print SCU AE

The existence of a print-job in the print queue will activate the Print SCU AE. An Association is established with the printer and the printer's status determined. If the printer is operating normally, the film sheets described within the print-job will be printed. If the printer is not operating normally, an error message will be displayed and this print-job can be canceled or restarted by the user operations.

4.1.3 Sequencing of Real-World Activities

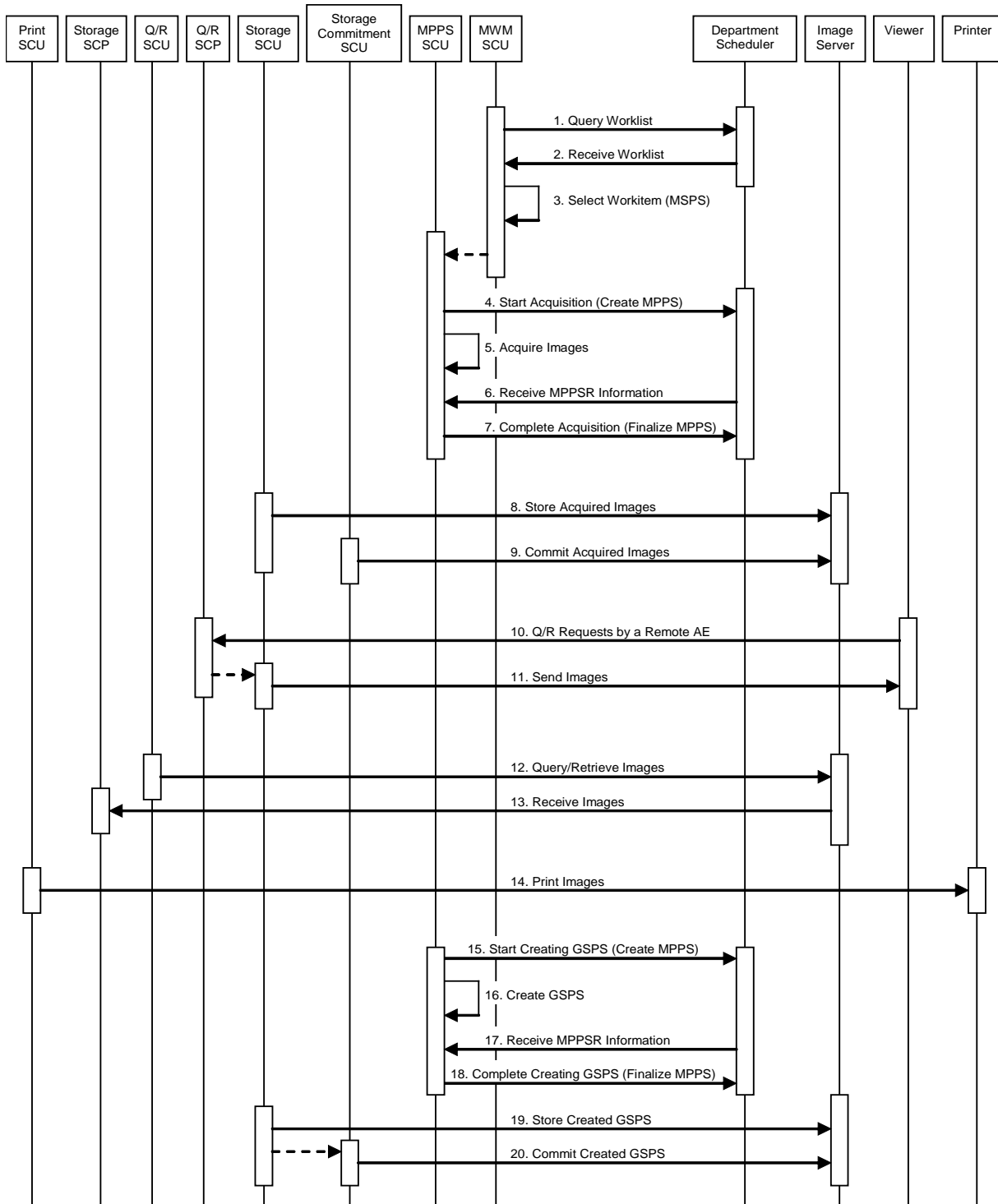

Figure 4.1-2
SEQUENCING CONSTRAINTS

Under typical scheduled workflow conditions the sequencing constraints illustrated in Figure 4.1-2 apply:

1. Query Worklist
2. Receive Worklist of Modality Scheduled Procedure Steps (MSPS)
3. Select Workitem (MSPS) from Worklist
4. Start Acquisition and Create MPPS
5. Acquire Images
6. Receive MPPSR Information
7. Complete Acquisition and Finalize MPPS
8. Store Acquired Images
9. Commit Acquired Images
10. Q/R Requests by a Remote AE
11. Send Images
12. Query/Retrieve Images
13. Receive Images
14. Print Images
15. Start Creating GSPS and Create MPPS
16. Create GSPS
17. Receive MPPSR Information
18. Complete Creating GSPS and Finalize MPPS
19. Store Created GSPS
20. Commit Created GSPS

Other workflow situations (e.g. unscheduled procedure steps) will have other sequencing constraints. Some activities may be omitted according to situations.

4.2 AE SPECIFICATIONS

4.2.1 Storage SCU AE Specification

4.2.1.1 SOP Classes

The Storage SCU AE provides Standard Conformance to the following SOP Classes:

**Table 4.2-1
SOP CLASSES FOR THE STORAGE SCU AE**

SOP Class Name	SOP Class UID	SCU	SCP
Verification	1.2.840.10008.1.1	Yes	No
CT Image Storage	1.2.840.10008.5.1.4.1.1.2	Yes	No
Secondary Capture Image Storage	1.2.840.10008.5.1.4.1.1.7	Yes	No
Standalone Curve Storage	1.2.840.10008.5.1.4.1.1.9	Yes	No
Enhanced CT Image Storage	1.2.840.10008.5.1.4.1.1.2.1	Yes	No
Grayscale Softcopy Presentation State Storage	1.2.840.10008.5.1.4.1.1.11.1	Yes	No
Enhanced SR Storage	1.2.840.10008.5.1.4.1.1.88.22	Yes	No
X-Ray Radiation Dose SR Storage	1.2.840.10008.5.1.4.1.1.88.67	Yes	No
Segmentation Storage	1.2.840.10008.5.1.4.1.1.66.4	Yes	No

4.2.1.2 Association Policies

4.2.1.2.1 General

The DICOM standard application context name for DICOM 3.0 is always proposed:

**Table 4.2-2
DICOM APPLICATION CONTEXT FOR THE STORAGE SCU AE**

Application Context Name	1.2.840.10008.3.1.1.1
--------------------------	-----------------------

4.2.1.2.2 Number of Associations

The Storage SCU AE can initiate up to two Associations at a time for each destination to which a transfer request is being processed in the active job queue list. Up to two jobs, that images will be sent to the different remote hosts, will be active at a time, the other remains pending until the active job is completed or failed.

**Table 4.2-3
NUMBER OF ASSOCIATIONS INITIATED FOR THE STORAGE SCU AE**

Maximum number of simultaneous Associations	2
---	---

4.2.1.2.3 Asynchronous Nature

The Storage SCU AE does not support asynchronous communication (multiple outstanding transactions over a single Association).

**Table 4.2-4
ASYNCHRONOUS NATURE FOR THE STORAGE SCU AE**

Maximum number of outstanding asynchronous transactions	1
---	---

4.2.1.2.4 Implementation Identifying Information

The implementation information for the Storage SCU AE is:

**Table 4.2-5
DICOM IMPLEMENTATION CLASS AND VERSION FOR THE STORAGE SCU AE**

Implementation Class UID	1.2.392.200036.9116.2.6.1.100
Implementation Version Name	TM_CT_CMW_V3.00

4.2.1.3 Association Initiation Policy

4.2.1.3.1 Activity – Send Images

4.2.1.3.1.1 Description and Sequencing of Activities

The Storage SCU AE attempts to initiate a new Association in order to issue a Verification request (C-ECHO) if needed.

The Storage SCU AE attempts to initiate a new Association in order to issue a Storage request (C-STORE). If the job contains multiple images then multiple C-STORE requests will be issued over the same Association. If the image transfer fails, the Storage SCU AE will retry this send-job automatically.

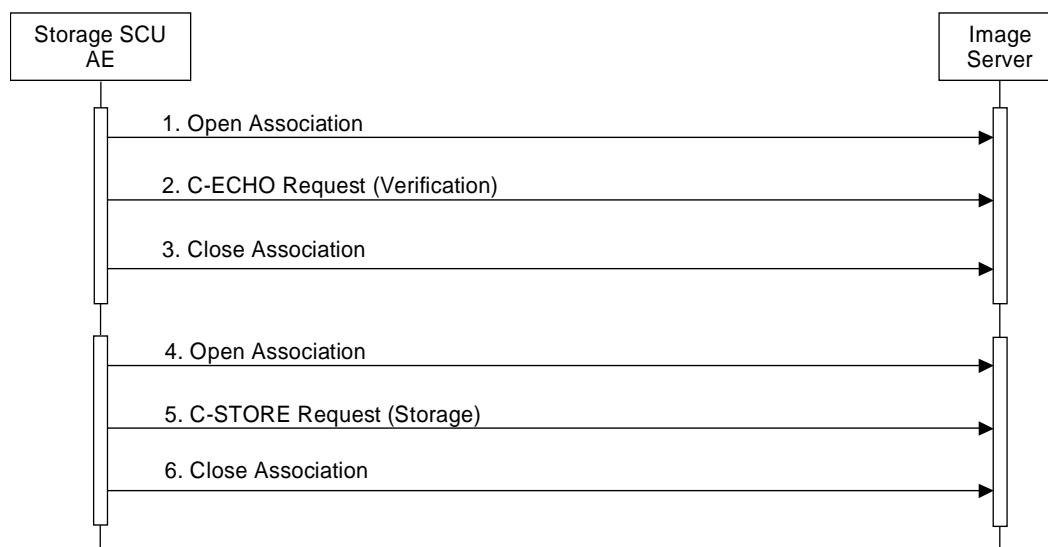

Figure 4.2-1
SEQUENCING OF ACTIVITY – SEND IMAGES

A possible sequence of interactions between the Storage SCU AE and an Image Server (e.g. a storage or archive device supporting the Verification and Storage SOP Classes as an SCP) is illustrated in the Figure above:

1. The Storage SCU AE opens an Association with the Image Server.
2. The Storage SCU AE issues a Verification request (C-ECHO) and the Image Server replies with a C-ECHO response (status success).
3. The Storage SCU AE closes the Association with the Image Server.
4. The Storage SCU AE opens an Association with the Image Server
5. Acquired images are transmitted to the Image Server using a Storage request (C-STORE) and the Image Server replies with a C-STORE response (status success).
6. The Storage SCU AE closes the Association with the Image Server.

4.2.1.3.1.2 Proposed Presentation Contexts

The Storage SCU AE is capable of proposing the Presentation Contexts shown in the following table:

**Table 4.2-6
PROPOSED PRESENTATION CONTEXTS FOR ACTIVITY SEND IMAGES**

Presentation Context Table					
Abstract Syntax		Transfer Syntax		Role	Ext. Neg.
Name	UID	Name List	UID List		
Verification	1.2.840.10008.1.1	Implicit VR Little Endian	1.2.840.10008.1.2	SCU	None
CT Image Storage	1.2.840.10008.5.1 .4.1.1.2	Implicit VR Little Endian	1.2.840.10008.1.2	SCU	None
		Explicit VR Little Endian	1.2.840.10008.1.2.1		
		Explicit VR Big Endian	1.2.840.10008.1.2.2		
		JPEG Lossless, Non-Hierarchical,First-Order Prediction (Process 14 [Selection Value 1])	1.2.840.10008.1.2.4.70		
Secondary Capture Image Storage	1.2.840.10008.5.1 .4.1.1.7	Implicit VR Little Endian	1.2.840.10008.1.2	SCU	None
		Explicit VR Little Endian	1.2.840.10008.1.2.1		
		Explicit VR Big Endian	1.2.840.10008.1.2.2		
		JPEG Lossless, Non-Hierarchical,First-Order Prediction (Process 14 [Selection Value 1])	1.2.840.10008.1.2.4.70		
Standalone Curve Storage	1.2.840.10008.5.1 .4.1.1.9	Implicit VR Little Endian	1.2.840.10008.1.2	SCU	None
		Explicit VR Little Endian	1.2.840.10008.1.2.1		
		Explicit VR Big Endian	1.2.840.10008.1.2.2		
Enhanced CT Image Storage	1.2.840.10008.5.1 .4.1.1.2.1	Implicit VR Little Endian	1.2.840.10008.1.2	SCU	None
		Explicit VR Little Endian	1.2.840.10008.1.2.1		
		Explicit VR Big Endian	1.2.840.10008.1.2.2		
		JPEG Lossless, Non-Hierarchical,First-Order Prediction (Process 14 [Selection Value 1])	1.2.840.10008.1.2.4.70		
Grayscale Softcopy Presentation State Storage	1.2.840.10008.5.1 .4.1.1.11.1	Implicit VR Little Endian	1.2.840.10008.1.2	SCU	None
		Explicit VR Little Endian	1.2.840.10008.1.2.1		
		Explicit VR Big Endian	1.2.840.10008.1.2.2		
Enhanced SR Storage	1.2.840.10008.5.1 .4.1.1.88.22	Implicit VR Little Endian	1.2.840.10008.1.2	SCU	None
		Explicit VR Little Endian	1.2.840.10008.1.2.1		
		Explicit VR Big Endian	1.2.840.10008.1.2.2		
X-Ray Radiation Dose SR Storage	1.2.840.10008.5.1 .4.1.1.88.67	Implicit VR Little Endian	1.2.840.10008.1.2	SCU	None
		Explicit VR Little Endian	1.2.840.10008.1.2.1		
		Explicit VR Big Endian	1.2.840.10008.1.2.2		
Segmentation Storage	1.2.840.10008.5.1 .4.1.1.66.4	Implicit VR Little Endian	1.2.840.10008.1.2	SCU	None
		Explicit VR Little Endian	1.2.840.10008.1.2.1		
		Explicit VR Big Endian	1.2.840.10008.1.2.2		

4.2.1.3.1.3 SOP Specific Conformance for Verification SOP Class

The Storage SCU AE provides standard conformance to the Verification Service Class as the SCU. It is initiated automatically at the "Send Images" activity.

The behavior of Storage SCU AE when encountering status codes in the C-ECHO response is summarized in the Table below:

**Table 4.2-7
VERIFICATION C-ECHO RESPONSE STATUS HANDLING BEHAVIOR**

Service Status	Further Meaning	Status Code	Behavior
Success	Success	0000	The Storage SCU AE judges the remote AE is present and active on the network.

The behavior of Storage SCU AE during communication failure is summarized in the Table below:

**Table 4.2-8
VERIFICATION COMMUNICATION FAILURE BEHAVIOR**

Exception	Behavior
Timeout	The Association is aborted using A-ABORT and the send job is marked as failed. The reason is logged and the job failure is reported to the user via the job control application.
Association aborted by the SCP or network layers	The send job is marked as failed. The reason is logged and the job failure is reported to the user via the job control application.

4.2.1.3.1.4 SOP Specific Conformance for Storage SOP Classes

The Storage SCU AE provides standard conformance to the Storage Service Class as the SCU.

The behavior of Storage SCU AE when encountering status codes in the C-STORE response is summarized in the Table below:

**Table 4.2-9
STORAGE C-STORE RESPONSE STATUS HANDLING BEHAVIOR**

Service Status	Further Meaning	Status Code	Behavior
Success	Success	0000	The SCP has successfully stored the SOP Instance. If all SOP Instances in a send job have status success then the job is marked as complete.
Refused	Out of Resources	A7xx	The Association is aborted using A-ABORT and the send job is marked as failed. The status meaning is logged and the job failure is reported to the user via the job control application. This is a transient failure.
Error	Data Set does not match SOP Class	A9xx	The Association is aborted using A-ABORT and the send job is marked as failed. The status meaning is logged and the job failure is reported to the user via the job control application.
Error	Cannot Understand	Cxxx	The Association is aborted using A-ABORT and the send job is marked as failed. The status meaning is logged and the job failure is reported to the user via the job control application.
Warning	Coercion of Data Elements	B000	Image transmission is considered successful if it is configured that the status would be considered successful.
Warning	Data Set does not match SOP Class	B007	Image transmission is considered successful if it is configured that the status would be considered successful.
Warning	Elements Discarded	B006	Image transmission is considered successful if it is configured that the status would be considered successful.
*	*	Any other status code.	The Association is aborted using A-ABORT and the send job is marked as failed. The status code is logged and the job failure is reported to the user via the job control application.

The behavior of Storage SCU AE during communication failure is summarized in the Table below:

**Table 4.2-10
STORAGE COMMUNICATION FAILURE BEHAVIOR**

Exception	Behavior
Timeout	The Association is aborted using A-ABORT and the send job is marked as failed. The reason is logged and the job failure is reported to the user via the job control application.
Association aborted by the SCP or network layers	The send job is marked as failed. The reason is logged and the job failure is reported to the user via the job control application.

If the image transfer fails, the Storage SCU AE will retry this send-job automatically. The delay between resending failed jobs and the number of retries is also configurable.

The contents of Image Storage SOP Instances created by the Storage SCU AE conform to the DICOM Image IOD definitions and are described in section 8.1.

4.2.2 Storage Commitment SCU AE Specification

4.2.2.1 SOP Classes

The Storage Commitment SCU AE provides Standard Conformance to the following SOP Classes:

Table 4.2-11
SOP CLASSES FOR THE STORAGE COMMITMENT SCU AE

SOP Class Name	SOP Class UID	SCU	SCP
Storage Commitment Push Model	1.2.840.10008.1.20.1	Yes	No

4.2.2.2 Association Policies

4.2.2.2.1 General

The DICOM standard application context name for DICOM 3.0 is always proposed:

Table 4.2-12
DICOM APPLICATION CONTEXT FOR THE STORAGE COMMITMENT SCU AE

Application Context Name	1.2.840.10008.3.1.1.1
--------------------------	-----------------------

4.2.2.2.2 Number of Associations

The Storage Commitment SCU AE initiates one Association at a time.

Table 4.2-13
NUMBER OF ASSOCIATIONS INITIATED FOR THE STORAGE COMMITMENT SCU AE

Maximum number of simultaneous Associations	1
---	---

The Storage Commitment SCU AE accepts Associations to receive N-EVENT-REPORT notifications for the Storage Commitment Push Model SOP Class.

Table 4.2-14
NUMBER OF ASSOCIATIONS ACCEPTED FOR THE STORAGE COMMITMENT SCU AE

Maximum number of simultaneous Associations	3
---	---

4.2.2.2.3 Asynchronous Nature

The Storage Commitment SCU AE does not support asynchronous communication (multiple outstanding transactions over a single Association).

Table 4.2-15
ASYNCHRONOUS NATURE FOR THE STORAGE COMMITMENT SCU AE

Maximum number of outstanding asynchronous transactions	1
---	---

4.2.2.2.4 Implementation Identifying Information

The implementation information for the Storage Commitment SCU AE is:

Table 4.2-16
DICOM IMPLEMENTATION CLASS AND VERSION FOR THE STORAGE COMMITMENT SCU AE

Implementation Class UID	1.2.392.200036.9116.2.6.1.100
Implementation Version Name	TM_CT_CMW_V3.00

4.2.2.3 Association Initiation Policy

4.2.2.3.1 Activity – Commit Sent Images

4.2.2.3.1.1 Description and Sequencing of Activities

If the remote AE is configured as an archive device the Storage Commitment SCU AE will, after all images have been sent, transmit a single Storage Commitment request (N-ACTION). Upon receiving the N-ACTION response the Storage Commitment SCU AE will release the Association. The notification of Storage commitment (N-EVENT-REPORT) will be received over a separate Association.

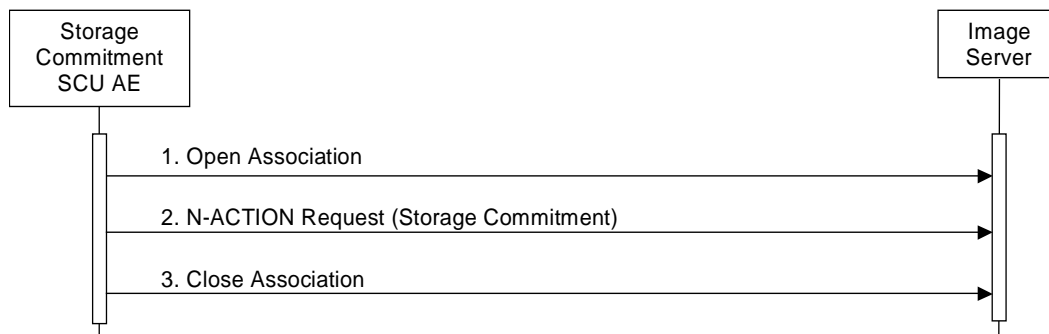

**Figure 4.2-2
SEQUENCING OF ACTIVITY – COMMIT SENT IMAGES**

A possible sequence of interactions between the Storage Commitment SCU AE and an Image Server (e.g. a storage or archive device supporting the Storage Commitment SOP Classes as an SCP) is illustrated in the Figure above:

1. The Storage Commitment SCU AE opens an Association with the Image Server.
2. A Storage Commitment request (N-ACTION) is transmitted to the Image Server to obtain Storage Commitment of previously transmitted images. The Image Server replies with an N-ACTION response indicating the request has been received and is being processed.
3. The Storage Commitment AE closes the Association with the Image Server.

NOTE: The N-EVENT-REPORT will be sent over a separate Association initiated by the Image Server (see Section 4.2.2.4.1).

4.2.2.3.1.2 Proposed Presentation Contexts

The Storage Commitment SCU AE is capable of proposing the Presentation Contexts shown in the following table:

**Table 4.2-17
PROPOSED PRESENTATION CONTEXTS FOR ACTIVITY COMMIT SENT IMAGES**

Presentation Context Table					
Abstract Syntax		Transfer Syntax		Role	Ext. Neg.
Name	UID	Name List	UID List		
Storage Commitment Push Model	1.2.840.10008.1.20.1	Implicit VR Little Endian	1.2.840.10008.1.2	SCU	None

Only one remote AE is configured as the Storage Commitment Push Mode SCP.

4.2.2.3.1.3 SOP Specific Conformance for Storage Commitment SOP Class

4.2.2.3.1.3.1 Storage Commitment Operations (N-ACTION)

The Storage Commitment SCU AE provides standard conformance to the Storage Commitment Service Class as the SCU.

The Storage Commitment SCU AE will request storage commitment for instances of the Storage SOP Classes if the remote AE is configured as an archive device and a presentation context for the Storage Commitment Push Model has been accepted.

The behavior of Storage SCU Commitment AE when encountering status codes in the N-ACTION response is summarized in the Table below:

**Table 4.2-18
STORAGE COMMITMENT N-ACTION RESPONSE STATUS HANDLING BEHAVIOR**

Service Status	Further Meaning	Status Code	Behavior
Success	Success	0000	The request for storage commitment is considered successfully sent. A timer is started which will expire if no N-EVENT-REPORT for the Transaction UID is received within a configurable timeout period.
*	*	Any other status code.	The Association is aborted using A-ABORT and the request for storage commitment is marked as failed.

The behavior of Storage Commitment AE during communication failure is summarized in the Table below:

**Table 4.2-19
STORAGE COMMITMENT COMMUNICATION FAILURE BEHAVIOR**

Exception	Behavior
Timeout	The Association is aborted using A-ABORT and the send job is marked as failed. The reason is logged and the job failure is reported to the user via the job control application.
Association aborted by the SCP or network layers	The send job is marked as failed. The reason is logged and the job failure is reported to the user via the job control application.

4.2.2.4 Association Acceptance Policy

4.2.2.4.1 Activity – Receive Storage Commitment Response

4.2.2.4.1.1 Description and Sequencing of Activities

The Storage Commitment SCU AE will accept Associations in order to receive responses to a Storage Commitment Request.

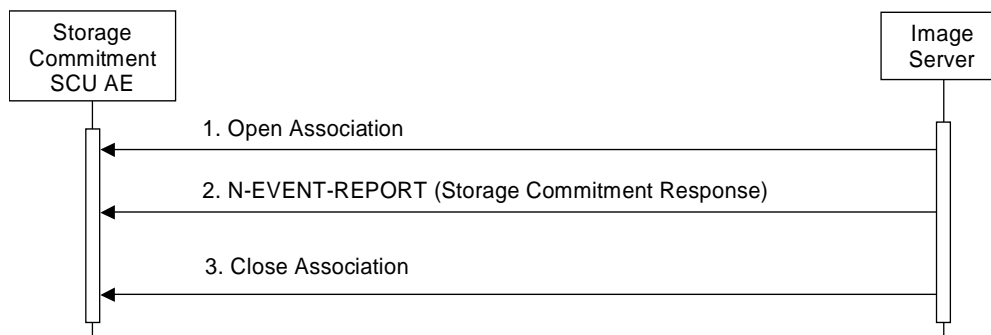

Figure 4.2-3
SEQUENCING OF ACTIVITY - RECEIVE STORAGE COMMITMENT RESPONSE

A possible sequence of interactions between the Storage Commitment SCU AE and an Image Server (e.g. a storage or archive device supporting Storage Commitment SOP Classes as an SCP) is illustrated in the Figure above:

1. The Image Server opens a new Association with the Storage Commitment SCU AE.
2. The Image Server sends an N-EVENT-REPORT request notifying the Storage SCU AE of the status of a previous Storage Commitment Request. The Storage SCU AE replies with a N-EVENT-REPORT response confirming receipt.
3. The Image Server closes the Association with the Storage Commitment SCU AE.

The Storage Commitment SCU AE may reject Association attempts as shown in the Table below. The Result, Source and Reason/Diag columns represent the values returned in the appropriate fields of an ASSOCIATE-RJ PDU (see PS 3.8, Section 9.3.4). The contents of the Source column is abbreviated to save space and the meaning of the abbreviations are:

- a) 1 – DICOM UL service-user
- b) 2 – DICOM UL service-provider (ASCE related function)
- c) 3 – DICOM UL service-provider (Presentation related function)

**Table 4.2-20
ASSOCIATION REJECTION REASONS**

Result	Source	Reason/Diag	Explanation
2 – rejected-transient	c	2 – local-limit-exceeded	The (configurable) maximum number of simultaneous Associations has been reached. An Association request with the same parameters may succeed at a later time.
2 – rejected-transient	c	1 – temporary-congestion	No Associations can be accepted at this time due to the real-time requirements of higher priority activities (e.g. during image acquisition no Associations will be accepted) or because insufficient resources are available (e.g. memory, processes, threads). An Association request with the same parameters may succeed at a later time.
1 – rejected-permanent	a	2 – application-context-name-not-supported	The Association request contained an unsupported Application Context Name. An Association request with the same parameters will not succeed at a later time.
1 – rejected-permanent	a	7 – called-AE-title-not-recognized	The Association request contained an unrecognized Called AE Title. An Association request with the same parameters will not succeed at a later time unless configuration changes are made. This rejection reason normally occurs when the Association initiator is incorrectly configured and attempts to address the Association acceptor using the wrong AE Title.
1 – rejected-permanent	a	3 – calling-AE-title-not-recognized	The Association request contained an unrecognized Calling AE Title. An Association request with the same parameters will not succeed at a later time unless configuration changes are made. This rejection reason normally occurs when the Association acceptor has not been configured to recognize the AE Title of the Association initiator.
1 – rejected-permanent	b	1 – no-reason-given	The Association request could not be parsed. An Association request with the same format will not succeed at a later time.

4.2.2.4.1.2 Accepted Presentation Contexts

The Storage Commitment SCU AE will accept Presentation Contexts as shown in the Table below.

**Table 4.2-21
ACCEPTABLE PRESENTATION CONTEXTS FOR
ACTIVITY RECEIVE STORAGE COMMITMENT RESPONSE**

Presentation Context Table					
Abstract Syntax		Transfer Syntax		Role	Ext. Neg.
Name	UID	Name List	UID List		
Storage Commitment Push Model	1.2.840.10008.1.20.1	Implicit VR Little Endian	1.2.840.10008.1.2	SCU	None

4.2.2.4.1.3 SOP Specific Conformance for Storage Commitment SOP Class

4.2.2.4.1.3.1 Storage Commitment Notifications (N-EVENT-REPORT)

The Storage Commitment SCU AE provides standard conformance to the Storage Commitment Service Class as the SCU.

The behavior of Storage Commitment SCU AE when receiving Event Types within the N-EVENT-REPORT is summarized in the Table below.

**Table 4.2-22
STORAGE COMMITMENT N-EVENT-REPORT BEHAVIOUR**

Event Type Name	Event Type ID	Behavior
Storage Commitment Request Successful	1	The Storage Commitment SCU AE permits the operator(s) to delete the Referenced SOP Instances under Referenced SOP Sequence (0018,1199), or deletes the Instances from the local database automatically.
Storage Commitment Request Complete – Failures Exist	2	The Storage Commitment SCU AE requests the Storage SCU AE to send the Referenced SOP Instances under Failed SOP Sequence (0018,1198).

The reasons for returning specific status codes in the N-EVENT-REPORT response are summarized in the Table below.

**Table 4.2-23
STORAGE COMMITMENT N-EVENT-REPORT RESPONSE STATUS REASONS**

Service Status	Further Meaning	Status Code	Reasons
Success	Success	0000	The storage commitment result has been successfully received.
Failure	Unrecognized Operation	0211H	The Transaction UID in the N-EVENT-REPORT request is not recognized (was never issued within an N-ACTION request).
Failure	Invalid Argument Value	0115H	One or more SOP Instance UIDs with the Referenced SOP Sequence (0008,1199) or Failed SOP Sequence (0008,1198) was not included in the Storage Commitment Request associated with this Transaction UID. The unrecognized SOP Instance UIDs will be returned within the Event Information of the N-EVENT-REPORT response.

4.2.3 Q/R SCP AE Specification

4.2.3.1 SOP Classes

The Q/R SCP AE provides Standard Conformance to the following SOP Classes:

**Table 4.2-24
SOP CLASSES FOR THE Q/R SCP AE**

SOP Class Name	SOP Class UID	SCU	SCP
Patient Root Q/R Information Model – Find	1.2.840.10008.5.1.4.1.2.1.1	No	Yes
Patient Root Q/R Information Model – Move	1.2.840.10008.5.1.4.1.2.1.2	No	Yes
Study Root Q/R Information Model – Find	1.2.840.10008.5.1.4.1.2.2.1	No	Yes
Study Root Q/R Information Model – Move	1.2.840.10008.5.1.4.1.2.2.2	No	Yes
Patient/Study Only Q/R Information Model – Find	1.2.840.10008.5.1.4.1.2.3.1	No	Yes
Patient/Study Only Q/R Information Model – Move	1.2.840.10008.5.1.4.1.2.3.2	No	Yes

4.2.3.2 Association Policies

4.2.3.2.1 General

The DICOM standard application context name for DICOM 3.0 is always proposed:

**Table 4.2-25
DICOM APPLICATION CONTEXT FOR THE Q/R SCP AE**

Application Context Name	1.2.840.10008.3.1.1.1
--------------------------	-----------------------

4.2.3.2.2 Number of Associations

The Q/R SCP AE can support up to three Associations at a time.

**Table 4.2-26
NUMBER OF ASSOCIATIONS ACCEPTED FOR THE Q/R SCP AE**

Maximum number of simultaneous Associations	3
---	---

4.2.3.2.3 Asynchronous Nature

The Q/R SCP AE does not support asynchronous communication (multiple outstanding transactions over a single Association).

**Table 4.2-27
ASYNCHRONOUS NATURE FOR THE Q/R SCP AE**

Maximum number of outstanding asynchronous transactions	1
---	---

4.2.3.2.4 Implementation Identifying Information

The implementation information for the Q/R SCP AE is:

**Table 4.2-28
DICOM IMPLEMENTATION CLASS AND VERSION FOR THE Q/R SCP AE**

Implementation Class UID	1.2.392.200036.9116.2.6.1.100
Implementation Version Name	TM_CT_CMW_V3.00

4.2.3.3 Association Initiation Policy

The Q/R SCP AE does not initiate Associations.

4.2.3.4 Association Acceptance Policy

4.2.3.4.1 Activity – Handle Q/R Requests

4.2.3.4.1.1 Description and Sequencing of Activities

The Q/R SCP AE accepts Associations only if they have valid Presentation Contexts. If none of the requested Presentation Contexts are accepted then the Association Request itself is rejected. It can be configured to only accept Associations with certain hosts (using TCP/IP address) and/or Application Entity Titles.

If the Q/R SCP AE receives a query (C-FIND) request then the response(s) will be sent over the same Association used to send the C-FIND-Request.

If the Q/R SCP AE receives retrieval (C-MOVE) request then the responses will be sent over the same Association used to send the C-MOVE-Request. The Q/R SCP AE will notify the Storage SCU AE to send the requested SOP Instances to the C-MOVE Destination AE. The Storage SCU AE notifies the Q/R SCP AE of the success or failure of each attempt to send a Composite SOP Instance to the peer C-MOVE Destination AE. The Q/R SCP AE then sends a C-MOVE Response indicating this status after each attempt. Once the Storage SCU AE has finished attempting to transfer all the requested SOP Instances, the Q/R SCP AE sends a final C-MOVE Response indicating the overall status of the attempted retrieval.

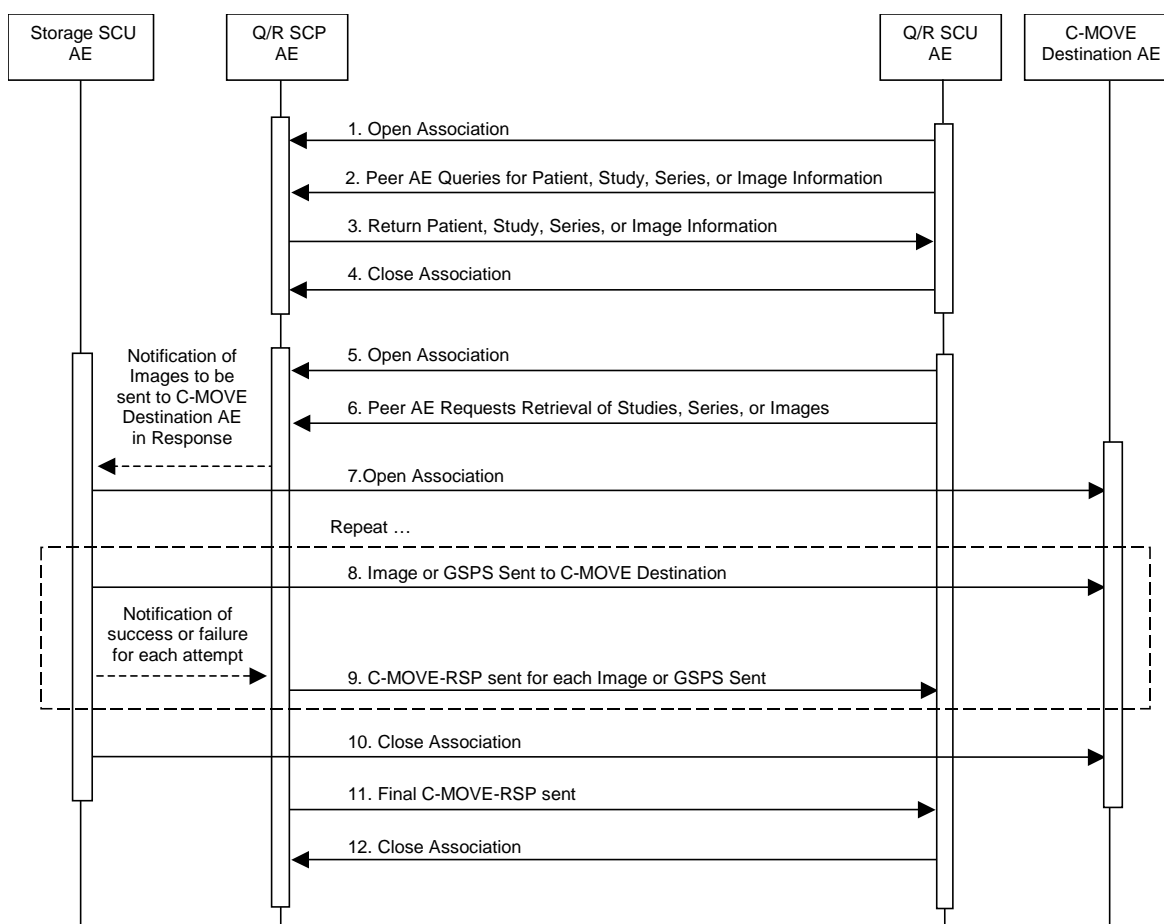

Figure 4.2-4
SEQUENCING OF ACTIVITY – HANDLE Q/R REQUESTS

The following sequencing constraints illustrated in the Figure above:

1. The Q/R SCU AE opens an Association with the Q/R SCP AE.
2. The Q/R SCU AE sends a C-FIND-RQ Message
3. The Q/R SCP AE returns a C-FIND-RSP Message to the Q/R SCU AE with matching information. A C-FIND-RSP is sent for each entity matching the identifier specified in the C-FIND-RQ. A final C-FIND-RSP is sent indicating that the matching is complete.
4. The Q/R SCU AE closes the Association.
5. The Q/R SCU AE opens an Association with the Q/R SCP AE.
6. The Q/R SCU AE sends a C-MOVE-RQ Message. The Q/R SCP AE notifies the Storage SCU AE to send the Composite SOP Instances to the peer C-MOVE Destination AE as indicated in the C-MOVE-RQ.
7. The Storage SCU AE opens an Association with the C-MOVE Destination AE.
8. The Storage SCU AE sends images to the C-MOVE Destination AE. The Storage SCU AE indicates to the Q/R SCP AE whether the transfer succeeded or failed.
9. The Q/R SCP AE then returns a C-MOVE-RSP indicating this success or failure.
10. The Storage SCU AE closes the Association.
11. The Q/R SCP AE sends a final C-MOVE-RSP indicating the overall success or failure of the retrieval.
12. The Q/R SCU AE closes the Association.

The Q/R SCP AE may reject Association attempts as shown in the table below. The Result, Source and Reason/Diag columns represent the values returned in the corresponding fields of an ASSOCIATE-RJ PDU (see PS 3.8, Section 9.3.4). The following abbreviations are used in the Source column:

- a. 1 – DICOM UL service-user
- b. 2 – DICOM UL service-provider (ASCE related function)
- c. 3 – DICOM UL service-provider (Presentation related function)

**Table 4.2-29
ASSOCIATION REJECTION REASONS**

Result	Source	Reason/Diag	Explanation
2 – rejected-transient	c	2 – local-limit-exceeded	The (configurable) maximum number of simultaneous Associations has been reached. An Association request with the same parameters may succeed at a later time.
2 – rejected-transient	c	1 – temporary-congestion	No Associations can be accepted at this time due to the real-time requirements of higher priority activities (e.g. during image acquisition no Associations will be accepted) or because insufficient resources are available (e.g. memory, processes, threads). An Association request with the same parameters may succeed at a later time.
1 – rejected-permanent	a	2 – application-context-name-not-supported	The Association request contained an unsupported Application Context Name. An association request with the same parameters will not succeed at a later time.
1 – rejected-permanent	a	7 – called-AE-title-not-recognized	The Association request contained an unrecognized Called AE Title. An Association request with the same parameters will not succeed at a later time unless configuration changes are made. This rejection reason normally occurs when the Association initiator is incorrectly configured and attempts to address the Association acceptor using the wrong AE Title.
1 – rejected-permanent	a	3 – calling-AE-title-not-recognized	The Association request contained an unrecognized Calling AE Title. An Association request with the same parameters will not succeed at a later time unless configuration changes are made. This rejection reason normally occurs when the Association acceptor has not been configured to recognize the AE Title of the Association initiator.
1 – rejected-permanent	b	1 – no-reason-given	The Association request could not be parsed. An Association request with the same format will not succeed at a later time.

4.2.3.4.1.2 Accepted Presentation Contexts

The default Behavior of the Q/R SCP AE supports the Implicit VR Little Endian and Explicit VR Big Endian Transfer Syntaxes for all Associations.

If the both Transfer Syntaxes are proposed per Presentation Context then the Q/R SCP AE will select Explicit VR Big Endian Transfer Syntax.

Any of the Presentation Contexts shown in the following table are acceptable to the Q/R SCP AE.

**Table 4.2-30
ACCEPTED PRESENTATION CONTEXTS BY THE Q/R SCP AE**

Presentation Context Table					
Abstract Syntax		Transfer Syntax		Role	Ext. Neg.
Name	UID	Name	UID		
Patient Root Q/R Information Model - FIND	1.2.840.10008.5.1.4 .1.2.1.1	Implicit VR Little Endian	1.2.840.10008.1.2	SCP	None
		Explicit VR Little Endian	1.2.840.10008.1.2.1		
		Explicit VR Big Endian	1.2.840.10008.1.2.2		
Patient Root Q/R Information Model - MOVE	1.2.840.10008.5.1.4 .1.2.1.2	Implicit VR Little Endian	1.2.840.10008.1.2	SCP	None
		Explicit VR Little Endian	1.2.840.10008.1.2.1		
		Explicit VR Big Endian	1.2.840.10008.1.2.2		
Study Root Q/R Information Model - FIND	1.2.840.10008.5.1.4 .1.2.2.1	Implicit VR Little Endian	1.2.840.10008.1.2	SCP	None
		Explicit VR Little Endian	1.2.840.10008.1.2.1		
		Explicit VR Big Endian	1.2.840.10008.1.2.2		
Study Root Q/R Information Model - MOVE	1.2.840.10008.5.1.4 .1.2.2.2	Implicit VR Little Endian	1.2.840.10008.1.2	SCP	None
		Explicit VR Little Endian	1.2.840.10008.1.2.1		
		Explicit VR Big Endian	1.2.840.10008.1.2.2		
Patient/Study Only Q/R Information Model - FIND	1.2.840.10008.5.1.4 .1.2.3.1	Implicit VR Little Endian	1.2.840.10008.1.2	SCP	None
		Explicit VR Little Endian	1.2.840.10008.1.2.1		
		Explicit VR Big Endian	1.2.840.10008.1.2.2		
Patient/Study Only Q/R Information Model - MOVE	1.2.840.10008.5.1.4 .1.2.3.2	Implicit VR Little Endian	1.2.840.10008.1.2	SCP	None
		Explicit VR Little Endian	1.2.840.10008.1.2.1		
		Explicit VR Big Endian	1.2.840.10008.1.2.2		

4.2.3.4.1.3 SOP Specific Conformance for Q/R Find SOP Classes

The Q/R SCP AE provides standard conformance to the Query/Retrieve Find SOP Class as the SCP. It supports hierarchical queries and not relational queries.

**Table 4.2-31
PATIENT ROOT C-FIND SCP SUPPORTED ELEMENTS**

Level Name Attribute Name	Tag	VR	Types of Matching
Patient Level			
Patient's Name	(0010,0010)	PN	S,*,U
Patient ID	(0010,0020)	LO	S,*,U
Patient's Sex	(0010,0040)	CS	S,*,U
Study Level			
Study Date	(0008,0020)	DA	S,R,U
Study Time	(0008,0030)	TM	R,U
Accession Number	(0008,0050)	SH	S,*,U
Patient's Age	(0010,1010)	AS	S,*,U
Study Instance UID	(0020,000D)	UI	S,*,U
Study ID	(0020,0010)	SH	S,*,U
Number of Study Related Series	(0020,1206)	IS	S,*,U
Number of Study Related Instances	(0020,1208)	IS	S,*,U
Series Level			
Modality	(0008,0060)	CS	S,*,U
Series Number	(0020,0011)	IS	S,*,U
Series Instance UID	(0020,000E)	UI	S,*,U
Instance Level			
SOP Instance UID	(0008,0018)	UI	S,*,U
Acquisition Date	(0008,0022)	DA	S,*,U
Contrast/Bolus Agent	(0018,0010)	LO	S,*,U
Scanning Sequence	(0018,0020)	CS	S,*,U
Slice Thickness	(0018,0050)	DS	S,*,U
KVP	(0018,0060)	DS	S,*,U
X-ray Tube Current	(0018,1151)	IS	S,*,U
Convolution Kernel	(0018,1210)	SH	S,*,U
Instance Number	(0020,0013)	IS	S,*,U

**Table 4.2-32
STUDY ROOT C-FIND SCP SUPPORTED ELEMENTS**

Level Name Attribute Name	Tag	VR	Types of Matching
Study Level			
Study Date	(0008,0020)	DA	S,R,U
Study Time	(0008,0030)	TM	R,U
Accession Number	(0008,0050)	SH	S,*,U
Patient's Name	(0010,0010)	PN	S,*,U
Patient ID	(0010,0020)	LO	S,*,U
Patient's Sex	(0010,0040)	CS	S,*,U
Patient's Age	(0010,1010)	AS	S,*,U
Study Instance UID	(0020,000D)	UI	S,*,U
Study ID	(0020,0010)	SH	S,*,U
Number of Study Related Series	(0020,1206)	IS	S,*,U
Number of Study Related Instances	(0020,1208)	IS	S,*,U
Series Level			
Modality	(0008,0060)	CS	S,*,U
Series Number	(0020,0011)	IS	S,*,U
Series Instance UID	(0020,000E)	UI	S,*,U
Instance Level			
SOP Instance UID	(0008,0018)	UI	S,*,U
Instance Number	(0020,0013)	IS	S,*,U
Acquisition Date	(0008,0022)	DA	S,R,U
Contrast/Bolus Agent	(0018,0010)	LO	S,*,U
Scanning Sequence	(0018,0020)	CS	S,*,U
Slice Thickness	(0018,0050)	DS	S,*,U
KVP	(0018,0060)	DS	S,*,U
X-ray Tube Current	(0018,1151)	IS	S,*,U
Convolution Kernel	(0018,1210)	SH	S,*,U
Instance Number	(0020,0013)	IS	S,*,U

**Table 4.2-33
PATIENT/STUDY ONLY C-FIND SCP SUPPORTED ELEMENTS**

Level Name Attribute Name	Tag	VR	Types of Matching
Patient Level			
Patient's Name	(0010,0010)	PN	S,*,U
Patient ID	(0010,0020)	LO	S,*,U
Patient's Sex	(0010,0040)	CS	S,*,U
Study Level			
Study Date	(0008,0020)	DA	S,R,U
Study Time	(0008,0030)	TM	R,U
Accession Number	(0008,0050)	SH	S,*,U
Patient's Age	(0010,1010)	AS	S,*,U
Study Instance UID	(0020,000D)	UI	S,*,U
Study ID	(0020,0010)	SH	S,*,U
Number of Study Related Series	(0020,1206)	IS	S,*,U
Number of Study Related Instances	(0020,1208)	IS	S,*,U

The tables should be read as follows:

Attribute Name: Attributes supported for returned C-FIND Responses.

Tag: Appropriate DICOM tag for this attribute.

VR: Appropriate DICOM VR for this attribute.

Types of Matching: The types of Matching supported by the C-FIND SCP.

A "S" indicates the identifier attribute can specify Single Value Matching, a "R" will indicate Range Matching, an "*" will denote wildcard matching, and a "U" will indicate universal matching.

Note:

The Q/R SCP AE supports Default Character Repertoire only.

The Q/R SCP AE returns C-FIND response status as specified below.

Table 4.2-34
THE Q/R SCP AE C-FIND RESPONSE STATUS RETURN BEHAVIOR

Service Status	Further Meaning	Status Code	Behavior
Success	Success	0000	Matching is complete. No final identifier is supplied.
Refused	Out of Resources	A700	System reached the limit in disk space or memory usage. Error message is output to as an alert to the User Interface, and to the Service Log.
Failed	Identifier does not match SOP Class	A900	The C-FIND query identifier contains invalid Elements or values, or is missing mandatory Elements or values for the specified SOP Class. Error message is output to the Service Log.
	Unable to process	C000	The C-FIND query identifier is valid for the specified SOP Class but cannot be used to query the database. For example, this can occur if received data contains unsupported character sets. (See section 6 'SUPPORT OF CHARACTER SET'.)
Cancel	Matching terminated due to Cancel Request	FE00	The C-FIND SCU sent a Cancel Request. This has been acknowledged and the search for matches has been halted.
Pending	Matches are continuing and current match is supplied.	FF00	Indicates that the search for further matches is continuing. This is returned when each successful match is returned and when further matches are forthcoming. This status code is returned if all Optional keys in the query identifier are actually supported.
	Matches are continuing but one or more Optional Keys were not supported.	FF01	Indicates that the search for further matches is continuing. This is returned when each successful match is returned and when further matches are forthcoming. This status code is returned if there are Optional keys in the query identifier that are not supported.

4.2.3.4.1.4 SOP Specific Conformance for Q/R Move SOP Classes

The Q/R SCP AE provides standard conformance to the Query/Retrieve Move SOP Classes as the SCP.

The Q/R SCP AE will convey to the Storage SCU AE that an Association with a DICOM Application Entity named by the external C-MOVE SCU (through a MOVE Destination AE Title) should be established. It will also convey to the Storage SCU AE to perform C-STORE operations on specific images requested by the external C-MOVE SCU.

The Q/R SCP AE returns C-MOVE response status as specified below.

Table 4.2-35
THE Q/R SCP AE C-MOVE RESPONSE STATUS RETURN BEHAVIOR

Service Status	Further Meaning	Status Code	Behavior
Success	Sub-operations complete – No Failures	0000	All the Composite SOP Instances have been successfully sent to the C-MOVE Destination AE.
Refused	Out of Resources – Unable to calculate number of matches	A701	Number of matches cannot be determined due to system failure. Returned if the server's database is not functioning so the search for matches to the C-MOVE Request cannot be found. Error message is output as an alert on the User Interface, and to the Service Log.
	Out of Resources – Unable to perform sub-operations	A702	C-STORE sub-operations cannot be performed due to failure to access Composite SOP Instances in archive, or failure of a C-STORE Request. Error message is output as an alert on the User Interface, and to the Service Log.
	Move destination unknown	A801	The Destination Application Entity named in the C-MOVE Request is unknown to Q/R SCP AE. Error message is output to the Service Log.
Failed	Identifier does not match SOP Class	A900	The C-MOVE identifier contains invalid Elements or values, or is missing mandatory Elements or values for the specified SOP Class or retrieval level. Error message is output to the Service Log.
Cancel	Matching terminated due to Cancel Request	FE00	The C-MOVE SCU sent a Cancel Request. This has been acknowledged and the export of Composite SOP Instances to the C-MOVE Destination AE has been halted.

4.2.4 MWM SCU AE Specification

4.2.4.1 SOP Classes

The MWM SCU AE provides Standard Conformance to the following SOP Classes:

Table 4.2-36
SOP CLASSES FOR THE MWM SCU AE

SOP Class Name	SOP Class UID	SCU	SCP
Modality Worklist Information Model – FIND	1.2.840.10008.5.1.4.31	Yes	No

4.2.4.2 Association Policies

4.2.4.2.1 General

The DICOM standard application context name for DICOM 3.0 is always proposed:

Table 4.2-37
DICOM APPLICATION CONTEXT FOR THE MWM SCU AE

Application Context Name	1.2.840.10008.3.1.1.1
--------------------------	-----------------------

4.2.4.2.2 Number of Associations

The MWM SCU AE initiates one Association at a time for a Worklist request.

Table 4.2-38
NUMBER OF ASSOCIATIONS INITIATED FOR THE MWM SCU AE

Maximum number of simultaneous Associations	1
---	---

4.2.4.2.3 Asynchronous Nature

The MWM SCU AE does not support asynchronous communication (multiple outstanding transactions over a single Association).

Table 4.2-39
ASYNCHRONOUS NATURE FOR THE MWM SCU AE

Maximum number of outstanding asynchronous transactions	1
---	---

4.2.4.2.4 Implementation Identifying Information

The implementation information for this Application Entity is:

Table 4.2-40
DICOM IMPLEMENTATION CLASS AND VERSION FOR THE MWM SCU AE

Implementation Class UID	1.2.392.200036.9116.2.6.1.100
Implementation Version Name	TM_CT_CMW_V3.00

4.2.4.3 Association Initiation Policy

4.2.4.3.1 Activity – Update Worklist

4.2.4.3.1.1 Description and Sequencing of Activities

The request for a “Update Worklist” is initiated by user interaction, i.e. pressing the buttons “Worklist Reload” or automatically at the time of key-word change.

Upon initiation of the request, the MWM SCU AE will build an Identifier for the C-FIND request, will initiate an Association to send the request and will wait for Worklist responses. After retrieval of all responses, the MWM SCU AE will access the local database to add or update patient demographic data. The results will be displayed in a separate list.

The MWM SCU AE will initiate an Association in order to issue a C-FIND request according to the Modality Worklist Information Model.

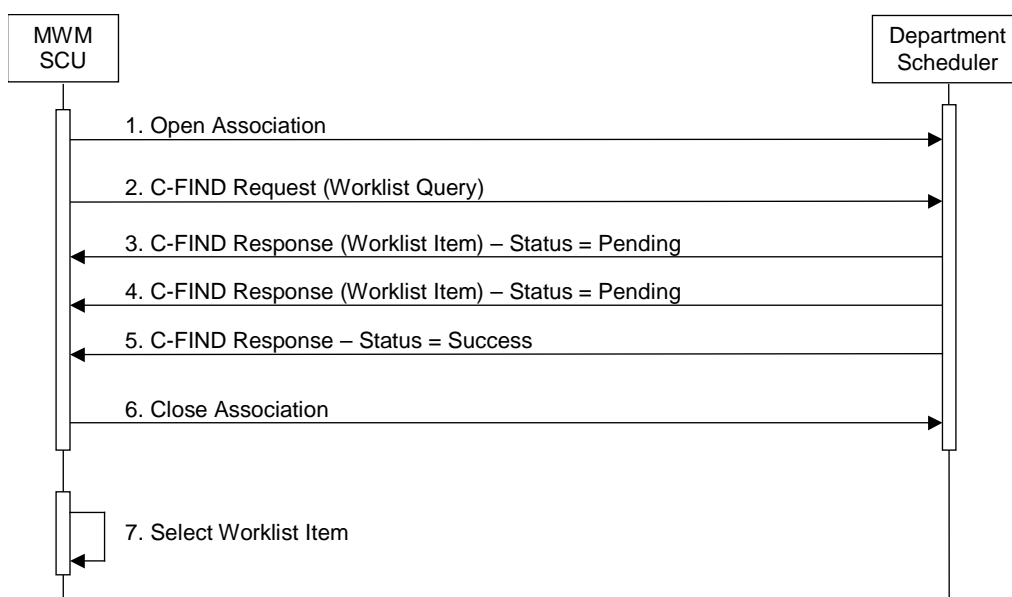

Figure 4.2-5
SEQUENCING OF ACTIVITY – UPDATE WORKLIST

A possible sequence of interactions between the MWM SCU AE and a Department Scheduler (e.g. a device such as a RIS or HIS which supports the Modality Worklist SOP Class as an SCP) is illustrated in the Figure above:

1. The MWM SCU AE opens an association with the Department Scheduler
2. The MWM SCU AE sends a C-FIND request to the Department Scheduler containing the Worklist Query attributes.
3. The Department Scheduler returns a C-FIND response containing the requested attributes of the first matching Worklist Item.
4. The Department Scheduler returns another C-FIND response containing the requested attributes of the second matching Worklist Item.
5. The Department Scheduler returns another C-FIND response with status Success indicating that no further matching Worklist Items exist. This example assumes that only 2 Worklist items match the Worklist Query.
6. The MWM SCU AE closes the association with the Department Scheduler.
7. The user selects a Worklist Item from the Worklist and prepares to acquire new images.

4.2.4.3.1.2 Proposed Presentation Contexts

The MWM SCU AE will propose Presentation Contexts as shown in the following table:

**Table 4.2-41
Proposed Presentation Contexts for Activity Update Worklist**

Presentation Context Table					
Abstract Syntax		Transfer Syntax		Role	Ext. Neg.
Name	UID	Name List	UID List		
Modality Worklist Information Model – FIND	1.2.840.10008.5.1.4.31	Implicit VR Little Endian	1.2.840.10008.1.2	SCU	None

4.2.4.3.1.3 SOP Specific Conformance for Modality Worklist SOP Class

The MWM SCU AE provides standard conformance to the Modality Worklist SOP Class as the SCU.

The behavior of the MWM SCU when encountering status codes in the Modality Worklist C-FIND response is summarized in the Table below.

**Table 4.2-42
Modality Worklist C-FIND Response Status Handling Behavior**

Service Status	Further Meaning	Status Code	Behavior
Success	Matching is complete	0000	The SCP has completed the matches. Worklist items are available for display or further processing.
Refused	Out of Resources	A700	The Association is aborted using A-ABORT and the worklist query is marked as failed. The status meaning is logged and reported to the user if an interactive query. Any additional error information in the Response will be logged.
Failed	Identifier does not match SOP Class	A900	The Association is aborted using A-ABORT and the worklist query is marked as failed. The status meaning is logged and reported to the user if an interactive query. Any additional error information in the Response will be logged.
Failed	Unable to Process	Cxxx	The Association is aborted using A-ABORT and the worklist query is marked as failed. The status meaning is logged and reported to the user if an interactive query. Any additional error information in the Response will be logged.
Cancel	Matching terminated due to Cancel request	FE00	If the query was cancelled due to too many worklist items then the SCP has completed the matches. Worklist items are available for display or further processing. Otherwise, the Association is aborted using A-ABORT and the worklist query is marked as failed. The status meaning is logged and reported to the user if an interactive query.
Pending	Matches are continuing	FF00	The worklist item contained in the Identifier is collected for later display or further processing.
Pending	Matches are continuing – Warning that one or more Optional Keys were not supported	FF01	The worklist item contained in the Identifier is collected for later display or further processing. The status meaning is logged only once for each C-FIND operation.
*	*	Any other status code.	The Association is aborted using A-ABORT and the worklist is marked as failed. The status meaning is logged and reported to the user if an interactive query. Any additional error information in the Response will be logged.

The behavior of the MWM SCU AE during communication failure is summarized in the Table below.

**Table 4.2-43
MODALITY WORKLIST COMMUNICATION FAILURE BEHAVIOR**

Exception	Behavior
Timeout	The Association is aborted using A-ABORT and the worklist query is marked as failed. The reason is logged and reported to the user if an interactive query.
Association aborted by the SCP or network layers	The worklist query is marked as failed. The reason is logged and reported to the user if an interactive query.

Acquired images will always use the Study Instance UID specified for the Scheduled Procedure Step (if available). If an acquisition is unscheduled, a Study Instance UID will be generated locally.

The Table below provides a description of the MWM SCU AE Worklist Request Identifier and specifies the attributes that are copied into the images. Unexpected attributes returned in a C-FIND response are ignored.

**Table 4.2-44
WORKLIST REQUEST IDENTIFIER**

Module Name Attribute Name	Tag	VR	M	R	D	IOD
SOP Common						
Specific Character Set	(0008,0005)	CS		x		x
Scheduled Procedure Step						
Scheduled Procedure Step Sequence	(0040,0100)	SQ		x		
> Scheduled Station AE Title	(0040,0001)	AE		x		
> Scheduled Station Name	(0040,0010)	LO		x		
> Scheduled Procedure Step Location	(0040,0011)	SH		x		
> Scheduled Procedure Step Start Date	(0040,0002)	DA		x	x	
> Scheduled Procedure Step Start Time	(0040,0003)	TM		x	x	
> Scheduled Procedure Step End Date	(0040,0004)	DA		x		
> Scheduled Procedure Step End Time	(0040,0005)	TM		x		
> Scheduled Performing Physician's Name	(0040,0006)	PN		x		
> Scheduled Procedure Step Description	(0040,0007)	SH		x		x
> Scheduled Protocol Code Sequence	(0040,0008)	SQ		x		x
> Scheduled Procedure Step ID	(0040,0009)	SH		x		x
> Scheduled Procedure Step Status	(0040,0020)	CS				
> Comments on Scheduled Procedure Step	(0040,0400)	LT		x		
> Modality	(0008,0060)	CS	S(CT)	x	x	x
> Requested Contrast Agent	(0032,1070)	LO		x		x
> Pre-Medication	(0040,0012)	LO		x		
Requested Procedure						
Requested Procedure ID	(0040,1001)	SH		x		
Reason for the Requested Procedure	(0040,1002)	LO		x		
Requested Procedure Comments	(0040,1400)	LT		x		
Requested Procedure Code Sequence	(0032,1064)	SQ		x		
Referenced Study Sequence	(0008,1110)	SQ		x		
Requested Procedure Description	(0032,1060)	LO		x		
Study Instance UID	(0020,000D)	UI		x	x	x
Requested Procedure Priority	(0040,1003)	SH		x		
Patient Transport Arrangements	(0040,1004)	LO		x		
Requested Procedure Location	(0040,1005)	LO		x		
Confidentiality Code	(0040,1008)	LO		x		
Reporting Priority	(0040,1009)	SH		x		
Names of Intended Recipients of Results	(0040,1010)	PN		x		

Imaging Service Request						
Reason for the Imaging Service Request	(0040,2001)	LO		x		
Imaging Service Request Comments	(0040,2400)	LT		x		
Requesting Physician	(0032,1032)	PN		x		
Referring Physician's Name	(0008,0090)	PN		x		x
Requesting Service	(0032,1033)	LO		x		x
Accession Number	(0008,0050)	SH		x	x	x
Issue Date of Imaging Service Request	(0040,2004)	DA		x		
Issue Time of Imaging Service Request	(0040,2005)	TM		x		
Order Entered By	(0040,2008)	PN		x		
Order Enters Location	(0040,2009)	SH		x		
Order Callback Phone Number	(0040,2010)	SH		x		
Visit Relationship						
Referenced Patient Sequence	(0008,1120)	SQ		x		
Visit Identification						
Institution Name	(0008,0080)	LO		x		
Institution Address	(0008,0081)	ST		x		
Institution Code Sequence	(0008,0082)	SQ		x		
Admission ID	(0038,0010)	LO		x		
Issuer of Admission ID	(0038,0011)	LO		x		
Visit Status						
Visit Status ID	(0038,0008)	CS				
Current Patient Location	(0038,0300)	LO				
Patient's Institution Residence	(0038,0400)	LO				
Visit Comments	(0038,4000)	LT				
Visit Admission						
Referring Physician's Address	(0008,0092)	ST		x		
Referring Physician's Telephone Number	(0008,0094)	SH		x		
Admitting Diagnosis Description	(0008,1080)	LO		x		
Admitting Diagnosis Code Sequence	(0008,1084)	SQ		x		
Route of Admissions	(0038,0016)	LO		x		
Admitting Date	(0038,0020)	DA		x		
Admitting Time	(0038,0021)	TM		x		
Patient Relationship						
Referenced Visit Sequence	(0008,1125)	SQ		x		
Referenced Patient Alias Sequence	(0038,0004)	SQ		x		
Patient Identification						
Patient's Name	(0010,0010)	PN		x	x	x
Patient ID	(0010,0020)	LO		x	x	x
Issuer of Patient ID	(0010,0021)	LO		x		
Other Patient IDs	(0010,1000)	LO		x		x
Other Patient Names	(0010,1001)	PN		x		x
Patient's Birth Name	(0010,1005)	PN		x		x
Patient's Mother's Birth Name	(0010,1060)	PN		x		x
Medical Record Locator	(0010,1090)	LO		x		

Patient Demographic						
Patient's Age	(0010,1010)	AS		x		x
Occupation	(0010,2180)	SH		x		
Patient Data Confidentiality Constraint Description	(0040,3001)	LO		x		
Patient's Birth Date	(0010,0030)	DA		x		x
Patient's Birth Time	(0010,0032)	TM		x		
Patient's Sex	(0010,0040)	CS		x		x
Patient's Insurance Plan Code Sequence	(0010,0050)	SQ		x		
Patient's Size	(0010,1020)	DS		x		x
Patient's Weight	(0010,1030)	DS		x		x
Patient's Address	(0010,1040)	LO		x		x
Military Rank	(0010,1080)	LO		x		
Branch of Service	(0010,1081)	LO		x		
Country Residence	(0010,2150)	LO		x		
Region of Residence	(0010,2152)	LO		x		
Patient's Telephone Number	(0010,2154)	SH		x		
Ethnic Group	(0010,2160)	SH		x		
Patient's Religious Reference	(0010,21F0)	LO		x		
Patient Comment	(0010,4000)	LT		x		x
Patient Medical						
Medical Alerts	(0010,2000)	LO		x		
Contrast Allergies	(0010,2110)	LO		x		x
Smoking Status	(0010,21A0)	CS		x		x
Additional Patient History	(0010,21B0)	LT		x		
Pregnancy Status	(0010,21C0)	US		x		x
Last Menstrual Date	(0010,21D0)	DA		x		
Special Needs	(0038,0050)	LO		x		
Patient State	(0038,0500)	LO		x		

The above table should be read as follows:

- Module Name: The name of the associated module for supported worklist attributes.
- Attribute Name: Attributes supported to build the MWM SCU AE Worklist Request Identifier.
- Tag: DICOM tag for this attribute.
- VR: DICOM VR for this attribute.
- M: Matching keys for (automatic) Worklist Update. An "S" will indicate that the MWM SCU AE will supply an attribute value for Single Value Matching. This setting can be configured using the user tool. The system's default setting is described in the above table.
- R: Return keys. An "x" will indicate that the MWM SCU AE will supply this attribute as Return Key with zero length for Universal Matching. This setting can be configured using the service tool. The system's default setting is described in the above table.
- D: Displayed keys. An "x" indicates that this worklist attribute is displayed to the user during a patient registration dialog. For example, Patient Name will be displayed when registering the patient prior to an examination. This setting can be configured using the service tool. The system's default setting is described in the above table.
- IOD: An "x" indicates that this Worklist attribute is included into all Object Instances created during performance of the related Procedure Step. This setting can be configured using the service tool. The system's default setting is described in the above table.

4.2.4.4 Association Acceptance Policy

The MWM SCU AE does not accept Associations.

4.2.5 MPPS SCU AE Specification

4.2.5.1 SOP Classes

The MPPS SCU AE provides Standard Conformance to the following SOP Classes:

Table 4.2-45
SOP CLASSES FOR THE MPPS SCU AE

SOP Class Name	SOP Class UID	SCU	SCP
Modality Performed Procedure Step	1.2.840.10008.3.1.2.3.3	Yes	No
Modality Performed Procedure Step Retrieve	1.2.840.10008.3.1.2.3.4	Yes	No

4.2.5.2 Association Policies

4.2.5.2.1 General

The DICOM standard application context name for DICOM 3.0 is always proposed:

Table 4.2-46
DICOM APPLICATION CONTEXT FOR THE MPPS SCU AE

Application Context Name	1.2.840.10008.3.1.1.1
--------------------------	-----------------------

4.2.5.2.2 Number of Associations

The MPPS SCU AE initiates one Association at a time.

Table 4.2-47
NUMBER OF ASSOCIATIONS INITIATED FOR THE MPPS SCU AE

Maximum number of simultaneous Associations	1
---	---

4.2.5.2.3 Asynchronous Nature

The MPPS SCU AE does not support asynchronous communication (multiple outstanding transactions over a single Association).

Table 4.2-48
ASYNCHRONOUS NATURE FOR THE MPPS SCU AE

Maximum number of outstanding asynchronous transactions	1
---	---

4.2.5.2.4 Implementation Identifying Information

The implementation information for this Application Entity is:

Table 4.2-49
DICOM IMPLEMENTATION CLASS AND VERSION FOR THE MPPS SCU AE

Implementation Class UID	1.2.392.200036.9116.2.6.1.100
Implementation Version Name	TM_CT_CMW_V3.00

4.2.5.3 Association Initiation Policy

4.2.5.3.1 Activity – Acquire Images

4.2.5.3.1.1 Description and Sequencing of Activities

The MPPS SCU AE performs the creation of a MPPS Instance automatically whenever images are acquired. Further updates on the MPPS data can be performed automatically or interactively.

The MPPS SCU AE will initiate an Association to issue an:

- N-CREATE request according to the CREATE Modality Performed Procedure Step SOP Instance operation, or an:
- N-GET request to get MPPSR information, or an:
- N-SET request to update the contents and state of the MPPS according to the SET Modality Performed Procedure Step Information operation.

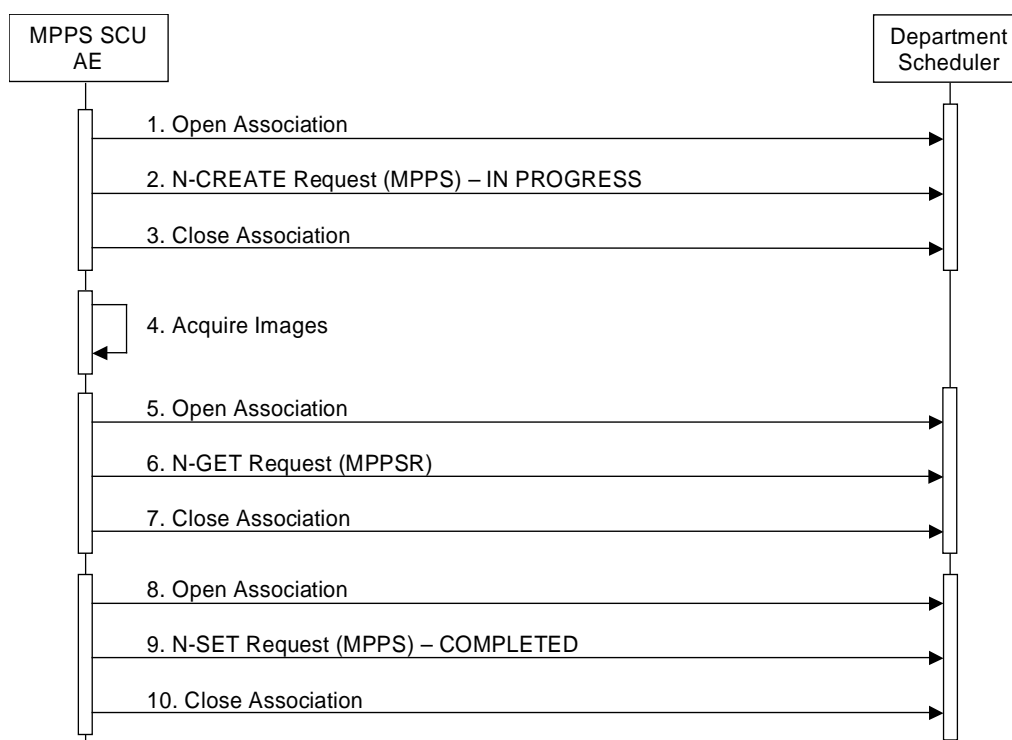

Figure 4.2-6
SEQUENCING OF ACTIVITY – ACQUIRE IMAGES

A possible sequence of interactions between the MPPS SCU AE and a Department Scheduler (e.g. a device such as a RIS or HIS which supports the MPPS SOP Class and MPPSR SCP Class as an SCP) is illustrated in the Figure above:

1. The MPPS SCU AE opens an association with the Department Scheduler
2. The MPPS SCU AE sends an N-CREATE request to the Department Scheduler to create an MPPS instance with status of “IN PROGRESS” and create all necessary attributes. The Department Scheduler acknowledges the MPPS creation with an N-CREATE response (status success).
3. The MPPS SCU AE closes the association with the Department Scheduler.

4. All images are acquired and stored in the local database. (Figure 4.2-6)
5. The MPPS SCU AE opens an association with the Department Scheduler.
6. The MPPS SCU AE sends an N-GET request to the Department Scheduler to get MPPSR information.
7. The MPPS SCU AE closes the association with the Department Scheduler.
8. The MPPS SCU AE opens an association with the Department Scheduler.
9. The MPPS SCU AE sends an N-SET request to the Department Scheduler to update the MPPS instance with status of "COMPLETED" and set all necessary attributes. The Department Scheduler acknowledges the MPPS update with an N-SET response (status success).
10. The MPPS SCU AE closes the association with the Department Scheduler.

4.2.5.3.1.2 Proposed Presentation Contexts

The MPPS SCU AE will propose Presentation Contexts as shown in the following Table:

**Table 4.2-50
PROPOSED PRESENTATION CONTEXTS FOR REAL-WORLD ACTIVITY ACQUIRE IMAGES**

Presentation Context Table					
Abstract Syntax		Transfer Syntax		Role	Ext. Neg.
Name	UID	Name List	UID List		
Modality Performed Procedure Step	1.2.840.10008.3.1.2.3.3	Implicit VR Little Endian	1.2.840.10008.1.2	SCU	None
		Explicit VR Big Endian	1.2.840.10008.1.2.2		
Modality Performed Procedure Step Retrieve	1.2.840.10008.3.1.2.3.4	Implicit VR Little Endian	1.2.840.10008.1.2	SCU	None
		Explicit VR Big Endian	1.2.840.10008.1.2.2		

4.2.5.3.1.3 SOP Specific Conformance for MPPS SOP Class

The MPPS SCU AE provides standard conformance to the Modality Performed Procedure Step SOP Class as the SCU.

The behavior of the MPPS SCU AE when encountering status codes in the MPPS N-CREATE or N-SET response is summarized in the Table below.

**Table 4.2-51
MPPS N-CREATE / N-SET RESPONSE STATUS HANDLING BEHAVIOR**

Service Status	Further Meaning	Status Code	Behavior
Success	Success	0000	The SCP has completed the operation successfully.
Failure	Processing Failure – Performed Procedure Step Object may no longer be updated	0110H	The Association is aborted using A-ABORT and the MPPS is marked as failed. The status meaning is logged and reported to the user. Additional information in the Response will be logged (i.e. Error Comment and Error ID).
Warning	Attribute Value Out of Range	0116H	The MPPS operation is considered successful if it is configured that the status would be considered successful.
*	*	Any other status code.	The Association is aborted using A-ABORT and the MPPS is marked as failed. The status meaning is logged and reported to the user.

The behavior of the MPPS SCU AE during communication failure is summarized in the Table below:

**Table 4.2-52
MPPS COMMUNICATION FAILURE BEHAVIOR**

Exception	Behavior
Timeout	The Association is aborted using A-ABORT and MPPS is marked as failed. The reason is logged and reported to the user.
Association aborted by the SCP or network layers	The MPPS is marked as failed. The reason is logged and reported to the user.

The Table below provides a description of the MPPS N-CREATE and N-SET request identifiers sent by the MPPS SCU AE. Empty cells in the N-CREATE and N-SET columns indicate that the attribute is not sent. An "x" indicates that an appropriate value will be sent. A "Zero length" attribute will be sent with zero length.

Table 4.2-53
MPPS N-CREATE / N-SET REQUEST IDENTIFIER

Attribute Name	Tag	VR	N-CREATE	N-SET
Specific Character Set	(0008,0005)	CS	Created, if an extended or replacement character set is used. Refer to 6.SUPPORT OF CHARACTER SETS	
Performed Procedure Step Relationship				
Scheduled Step Attributes Sequence	(0040,0270)	SQ	Always Set	
> Study Instance UID	(0020,000D)	UI	From Modality Worklist	
> Referenced Study Sequence	(0008,1110)	SQ	From Modality Worklist	
>> Referenced SOP Class UID	(0008,1150)	UI	From Modality Worklist	
>> Referenced SOP Instance UID	(0008,1155)	UI	From Modality Worklist	
> Accession Number	(0008,0050)	SH	From Modality Worklist	
> Placer Order Number/Imaging Service Request	(0040,2016)	LO	From Modality Worklist	
> Filler Order Number/Imaging Service Request	(0040,2017)	LO	From Modality Worklist	
> Requested Procedure ID	(0040,1001)	SH	From Modality Worklist	
> Requested Procedure Description	(0032,1060)	LO	From Modality Worklist	
> Scheduled Procedure Step ID	(0040,0009)	SH	From Modality Worklist	
> Scheduled Procedure Step Description	(0040,0007)	LO	From Modality Worklist	
> Scheduled Protocol Code Sequence	(0040,0008)	SQ	From Modality Worklist	
Patient's Name	(0010,0010)	PN	From Modality Worklist or user input	
Patient ID	(0010,0020)	LO	From Modality Worklist or user input.	
Patient's Birth Date	(0010,0030)	DA	From Modality Worklist or user input.	
Patient's Sex	(0010,0040)	CS	From Modality Worklist or user input.	
Referenced Patient Sequence	(0008,1120)	SQ	From Modality Worklist.	
Performed Procedure Step Information				
Performed Procedure Step ID	(0040,0253)	SH	Automatically created.	
Performed Station AE Title	(0040,0241)	AE	MPPS AE Title	
Performed Station Name	(0040,0242)	SH	From configuration	
Performed Location	(0040,0243)	SH	From configuration	
Performed Procedure Step Start Date	(0040,0244)	DA	Actual start date	
Performed Procedure Step Start Time	(0040,0245)	TM	Actual start time	

Performed Procedure Step Status	(0040,0252)	CS	IN PROGRESS	COMPLETED or DISCONTINUED
Performed Procedure Step Description	(0040,0254)	LO	From Modality Worklist.	
Performed Procedure Type Description	(0040,0255)	LO	From Modality Worklist.	
Procedure Code Sequence	(0008,1032)	SQ	Zero or more items	Zero or more items
Performed Procedure Step End Date	(0040,0250)	DA	Zero length	Actual end date
Performed Procedure Step End Time	(0040,0251)	TM	Zero length	Actual end time
Image Acquisition Results				
Modality	(0008,0060)	CS	CT	
Study ID	(0020,0010)	SH	From Modality Worklist or automatically created.	
Performed Protocol Code Sequence	(0040,0260)	SQ	Zero or more items	Zero or more items
Performed Series Sequence	(0040,0340)	SQ	Zero length	One or more items
> Performing Physician's Name	(0008,1050)	PN		x
> Protocol Name	(0018,1030)	LO		x
> Operator's Name	(0008,1070)	PN		x
> Series Instance UID	(0020,000E)	UI		x
> Series Description	(0008,103E)	LO		x
> Retrieve AE Title	(0008,0054)	AE		x
> Referenced Image Sequence	(0008,1140)	SQ		One or more items
>> Referenced SOP Class UID	(0008,1150)	UI		x
>> Referenced SOP Instance UID	(0008,1155)	UI		x
> Referenced Non-Image Composite SOP Instance Sequence	(0040,0220)	SQ		x
>> Referenced SOP Class UID	(0008,1150)	UI		x
>> Referenced SOP Instance UID	(0008,1155)	UI		x
Billing and Material Code				
Film Consumption Sequence	(0040,0321)	SQ		Zero or more items
>Number of Films	(2100,0170)	IS		x
>Medium Type	(2000,0030)	CS		x
>Film Size ID	(2010,0050)	CS		x
Billing Supplies and Devices Sequence	(0040,0324)	SQ		Zero or more items
>Quantity Sequence	(0040,0293)	SQ		x
>>Quantity	(0040,0294)	DS		x
>>Measuring Units Sequence	(0040,0295)	SQ		x

4.2.5.3.1.4 SOP Specific Conformance for MPPSR SOP Class

The MPPS SCU AE provides standard conformance to the Modality Performed Procedure Step Retrieve SOP Class as the SCU.

The behavior of the MPPS SCU AE when encountering status codes in the MPPSR N-GET response is summarized in the Table below.

**Table 4.2-54
MPPSR N-GET RESPONSE STATUS HANDLING BEHAVIOR**

Service Status	Further Meaning	Status Code	Behavior
Success	Success	0000	The SCP has completed the operation successfully.
*	*	Any other status code.	The Association is aborted using A-ABORT and the MPPSR is marked as failed. The status meaning is logged.

The behavior of the MPPS SCU AE during communication failure is summarized in the Table below:

**Table 4.2-55
MPPSR COMMUNICATION FAILURE BEHAVIOR**

Exception	Behavior
Timeout	The Association is aborted using A-ABORT and MPPSR is marked as failed. The reason is logged and reported to the user.
Association aborted by the SCP or network layers	The MPPSR is marked as failed. The reason is logged.

The Table below provides a description of the MPPSR N-GET request identifiers sent by the MPPS SCU AE.

**Table 4.2-56
MPPSR SOP CLASS N-GET REQUEST ATTRIBUTES**

Attribute Name	Tag	VR	Value
Performed Procedure Step Information			
Performed Procedure Step Description	(0040,0254)	LO	The Value sent by the MPPS SCU AE in the MPPS N-CREATE.
Performed Procedure Type Description	(0040,0255)	LO	The Value sent by the MPPS SCU AE in the MPPS N-CREATE.

4.2.5.4 Association Acceptance Policy

The MPPS SCU AE does not accept Associations.

4.2.6 Q/R SCU AE Specification

4.2.6.1 SOP Classes

The Q/R SCU AE provides Standard Conformance to the following SOP Classes:

Table 4.2-57
SOP CLASSES FOR THE Q/R SCU AE

SOP Class Name	SOP Class UID	SCU	SCP
Study Root Q/R Information Model – Find	1.2.840.10008.5.1.4.1.2.2.1	Yes	No
Study Root Q/R Information Model – Move	1.2.840.10008.5.1.4.1.2.2.2	Yes	No

4.2.6.2 Association Policies

4.2.6.2.1 General

The DICOM standard application context name for DICOM 3.0 is always proposed:

Table 4.2-58
DICOM APPLICATION CONTEXT FOR THE Q/R SCU AE

Application Context Name	1.2.840.10008.3.1.1.1
--------------------------	-----------------------

4.2.6.2.2 Number of Associations

The Q/R SCU AE can initiate up to three Associations at a time.

Table 4.2-59
NUMBER OF ASSOCIATIONS INITIATED FOR THE Q/R SCU AE

Maximum number of simultaneous Associations	3
---	---

4.2.6.2.3 Asynchronous Nature

The Q/R SCU AE does not support asynchronous communication (multiple outstanding transactions over a single Association).

Table 4.2-60
ASYNCHRONOUS NATURE FOR THE Q/R SCU AE

Maximum number of outstanding asynchronous transactions	1
---	---

4.2.6.2.4 Implementation Identifying Information

The implementation information for this Application Entity is:

Table 4.2-61
DICOM IMPLEMENTATION CLASS AND VERSION FOR THE Q/R SCU AE

Implementation Class UID	1.2.392.200036.9116.2.6.1.100
Implementation Version Name	TM_CT_CMW_V3.00

4.2.6.3 Association Initiation Policy

4.2.6.3.1 Activity – Query and Retrieve Images

4.2.6.3.1.1 Description and Sequencing of Activities

The Q/R SCU AE is activated when the user selects a remote node to query and enters some key information, Patient’s Name, Patient ID and/or Study Date. The user can select studies, series and images to be retrieved. The images will be received at the Storage SCP AE.

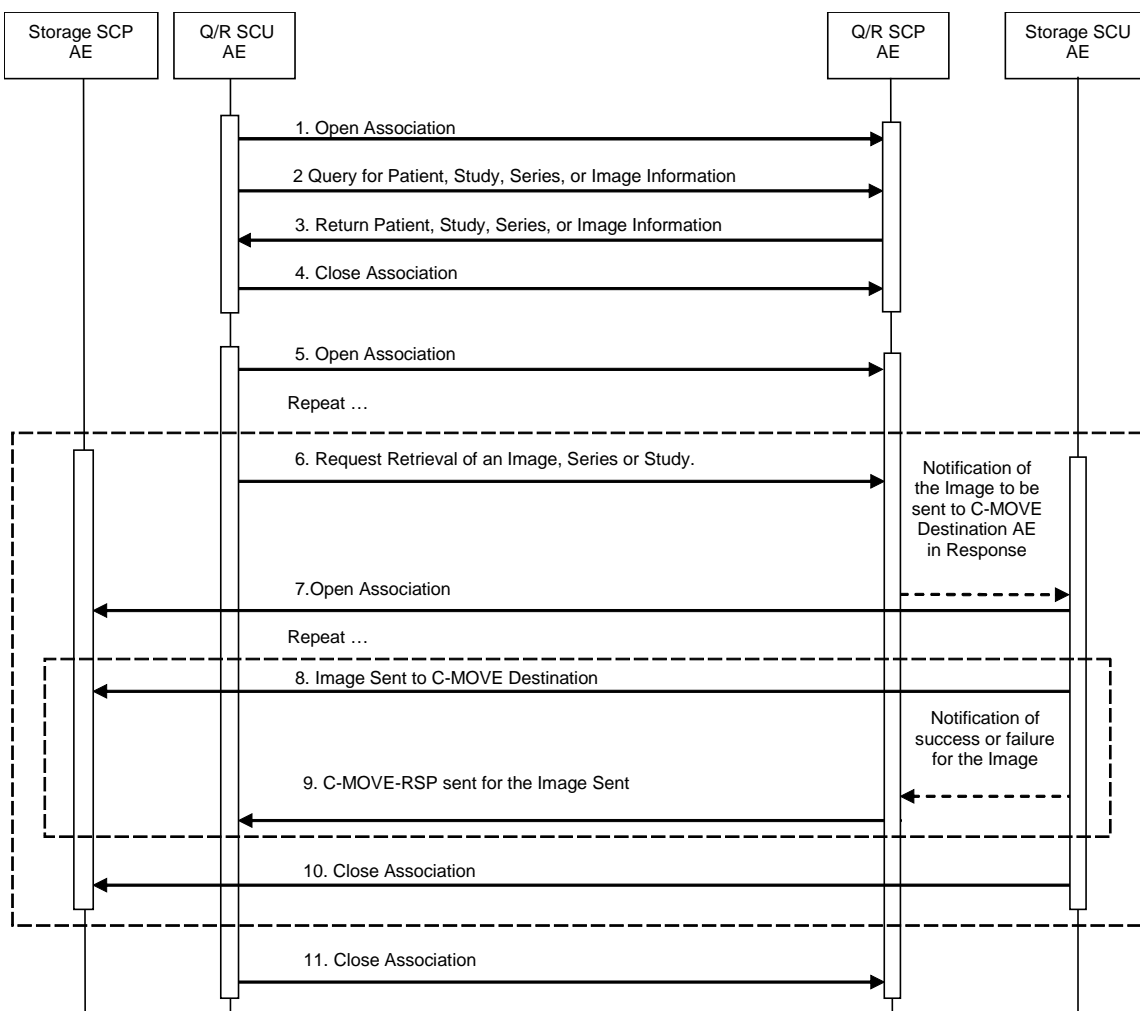

Figure 4.2-7
SEQUENCING OF ACTIVITY – QUERY AND RETRIEVE IMAGES

The following sequencing constraints illustrated in the Figure above:

1. The Q/R SCU AE opens an Association with the Q/R SCP AE.
2. The Q/R SCU AE sends a C-FIND-RQ Message
3. The Q/R SCP AE returns a C-FIND-RSP Message to the Q/R SCU AE with matching information. A C-FIND-RSP is sent for each entity matching the identifier specified in the C-FIND-RQ. A final C-FIND-RSP is sent indicating that the matching is complete.
4. The Q/R SCU AE closes the Association.
5. The Q/R SCU AE opens an Association with the Q/R SCP AE.
6. The Q/R SCU AE sends a C-MOVE-RQ Message. The Q/R SCP AE notifies the Storage SCU AE to send the Composite SOP Instances to the peer C-MOVE Destination AE as indicated in the C-MOVE-RQ.
7. The Storage SCU AE opens an Association with the C-MOVE Destination AE.
8. The Storage SCU AE sends images to the C-MOVE Destination AE. The Storage SCU AE indicates to the Q/R SCP AE whether the transfer succeeded or failed.
9. The Q/R SCP AE then returns a C-MOVE-RSP indicating this success or failure.
10. The Storage SCU AE closes the Association.
11. The Q/R SCU AE closes the Association.

4.2.6.3.1.2 Proposed Presentation Contexts

The Q/R SCU AE will propose Presentation Contexts as shown in the following Table:

Table 4.2-62
PROPOSED PRESENTATION CONTEXTS FOR REAL-WORLD ACTIVITY
QUERY AND RETRIEVE IMAGES

Presentation Context Table					
Abstract Syntax		Transfer Syntax		Role	Ext. Neg.
Name	UID	Name List	UID List		
Study Root Q/R Information Model – Find	1.2.840.10008.5.1.4.1.2.2.1	Implicit VR Little Endian	1.2.840.10008.1.2	SCU	None
		Explicit VR Little Endian	1.2.840.10008.1.2.1		
		Explicit VR Big Endian	1.2.840.10008.1.2.2		
Study Root Q/R Information Model – Move	1.2.840.10008.5.1.4.1.2.2.2	Implicit VR Little Endian	1.2.840.10008.1.2	SCU	None
		Explicit VR Little Endian	1.2.840.10008.1.2.1		
		Explicit VR Big Endian	1.2.840.10008.1.2.2		

4.2.6.3.1.3 SOP Specific Conformance for Q/R Find SOP Classes

The Q/R SCU AE provides standard conformance to the Query/Retrieve Find SOP Classes as the SCU.

The behavior of the Q/R SCU AE when encountering status codes in the Q/R C-FIND response is summarized in the Table below:

Table 4.2-63
THE Q/R SCU AE C-FIND RESPONSE STATUS BEHAVIOR

Service Status	Further Meaning	Status Code	Behavior
Success	Matching is complete	0000	The SCP has completed the matches. Study, Series or Image information items are available for display or further processing.
Refused	Out of Resources	A700	The Association is aborted using A-ABORT and the Study, Series, or Image information query is marked as failed. The status meaning is logged and reported to the user if an interactive query. Any additional error information in the Response will be logged.
Failed	Identifier does not match SOP Class	A900	The Association is aborted using A-ABORT and the Study, Series, or Image information query is marked as failed. The status meaning is logged and reported to the user if an interactive query. Any additional error information in the Response will be logged.
Failed	Unable to Process	Cxxx	The Association is aborted using A-ABORT and the Study, Series, or Image information query is marked as failed. The status meaning is logged and reported to the user if an interactive query. Any additional error information in the Response will be logged.
Cancel	Matching terminated due to Cancel request	FE00	The Association is aborted using A-ABORT and the Study, Series, or Image information query is marked as failed. The status meaning is logged and reported to the user if an interactive query.
Pending	Matches are continuing	FF00	The Study, Series, or Image information items contained in the Identifier is collected for later display or further processing.
Pending	Matches are continuing – Warning that one or more Optional Keys were not supported	FF01	The Study, Series, or Image information items contained in the Identifier is collected for later display or further processing.
*	*	Any other status code.	The Association is aborted using A-ABORT and the Study, Series, or Image information is marked as failed. The status meaning is logged and reported to the user if an interactive query. Any additional error information in the Response will be logged.

The behavior of the Q/R SCU AE during communication failure is summarized in the Table below.

Table 4.2-64
Q/R FIND COMMUNICATION FAILURE BEHAVIOR

Exception	Behavior
Timeout	The Association is aborted using A-ABORT and the study, series or image query is marked as failed. The reason is logged and reported to the user if an interactive query.
Association aborted by the SCP or network layers	The study, series or image query is marked as failed. The reason is logged and reported to the user if an interactive query.

All queries are initiated at the highest level of the information model (the STUDY level), and then for each response received, recursively repeated at the next lower levels (the SERIES and then IMAGE levels), in order to completely elucidate the “tree” of instances available on the remote AE.

The Table below provides a description of the Q/R SCU AE C-FIND Request Identifier.

Table 4.2-65
STUDY ROOT REQUEST IDENTIFIER FOR C-FIND

Name	Tag	Types of Matching
Study Level		
Study Date	(0008,0020)	S,*U,R
Study Time	(0008,0030)	S,*U,R
Accession Number	(0008,0050)	S,*U
Study Description	(0008,1030)	S,*U
Patient's Name	(0010,0010)	S,*U
Patient's ID	(0010,0020)	S,*U
Patient's Sex	(0010,0040)	S,*U
Patient's Age	(0010,1010)	S,*U
Study Instance UID	(0020,000D)	UNIQUE
Study ID	(0020,0010)	S,*U
Number of Study Related Series	(0020,1206)	U
Number of Study Related Instances	(0020,1208)	U
Series Level		
Modality	(0008,0060)	S,*U
Series Instance UID	(0020,000E)	UNIQUE
Series Number	(0020,0011)	S,*U
Instance Level		
SOP Instance UID	(0008,0018)	UNIQUE
Acquisition Date	(0008,0022)	S,*U,R
Contrast/Bolus Agent	(0018,0010)	U
Scanning Sequence	(0018,0020)	U
Slice Thickness	(0018,0050)	U
KVP	(0018,0060)	U
Repetition Time	(0018,0080)	U
Echo Time	(0018,0081)	U
Inversion Time	(0018,0082)	U
Echo Number(s)	(0018,0086)	U
Gantry/Detector Tilt	(0018,1120)	U
X-ray Tube Current	(0018,1151)	U
Convolution Kernel	(0018,1210)	U
Acquisition Number	(0020,0012)	U
Instance Number	(0020,0013)	U
Rows	(0028,0010)	U
Columns	(0028,0011)	U

Types of Matching:

The types of Matching supported by the Q/R SCU AE. An "S" indicates the identifier attribute uses Single Value Matching, an "R" indicates Range Matching, an "*" indicates wildcard matching, and a 'U' indicates Universal Matching. "UNIQUE" indicates that this is the Unique Key for that query level, in which case Universal Matching or Single Value Matching is used depending on the query level.

4.2.6.3.1.4 SOP Specific Conformance for Q/R Move SOP Classes

The Q/R SCU AE provides standard conformance to the Query/Retrieve Move SOP Classes as the SCU.

The behavior of the Q/R SCU AE when encountering status codes in the Q/R C-MOVE response is summarized in the Table below:

**Table 4.2-66
THE Q/R SCU AE C-MOVE RESPONSE STATUS BEHAVIOR**

Service Status	Further Meaning	Status Code	Behavior
Success	Sub-operations complete – No Failures	0000	The Storage SCP AE has successfully received the SOP Instance. If all SOP Instances in a move job have status success then the job is marked as complete.
Refused	Out of Resources – Unable to calculate number of matches	A701	The Association is aborted using A-ABORT and the move job is marked as failed. The status meaning is logged and the job failure is reported to the user via the job control application. This is a transient failure.
	Out of Resources – Unable to perform sub-operations	A702	The Association is aborted using A-ABORT and the move job is marked as failed. The status meaning is logged and the job failure is reported to the user via the job control application.
	Move destination unknown	A801	The Association is aborted using A-ABORT and the move job is marked as failed. The status meaning is logged and the job failure is reported to the user via the job control application.
Failed	Identifier does not match SOP Class	A900	The Association is aborted using A-ABORT and the move job is marked as failed. The status meaning is logged and the job failure is reported to the user via the job control application.
Warning	Sub-operations complete but one or more failures.	B000	The Association is aborted using A-ABORT and the move job is marked as failed. The status meaning is logged and the job failure is reported to the user via the job control application.

The behavior of the Q/R SCU AE during communication failure is summarized in the Table below.

**Table 4.2-67
Q/R MOVE COMMUNICATION FAILURE BEHAVIOR**

Exception	Behavior
Timeout	The Association is aborted using A-ABORT and the retrieve is marked as failed. The reason is logged and reported to the user if an interactive query.
Association aborted by the SCP or network layers	The retrieve is marked as failed. The reason is logged and reported to the user if an interactive query.

The system requests Image Level Move only.

4.2.6.4 Association Acceptance Policy

The Q/R SCU AE does not accept Associations.

4.2.7 Storage SCP AE Specification

4.2.7.1 SOP Classes

The Storage SCP AE provides Standard Conformance to the following SOP Classes:

Table 4.2-68
SOP CLASSES FOR THE STORAGE SCP AE

SOP Class Name	SOP Class UID	SCU	SCP
Verification	1.2.840.10008.1.1	No	Yes
CT Image Storage	1.2.840.10008.5.1.4.1.1.2	No	Yes
Secondary Capture Image Storage	1.2.840.10008.5.1.4.1.1.7	No	Yes
Standalone Curve Storage	1.2.840.10008.5.1.4.1.1.9	No	Yes
Enhanced CT Image Storage	1.2.840.10008.5.1.4.1.1.2.1	No	Yes
Grayscale Softcopy Presentation State Storage	1.2.840.10008.5.1.4.1.1.11.1	No	Yes
Enhanced SR Storage	1.2.840.10008.5.1.4.1.1.88.22	No	Yes
X-Ray Radiation Dose SR Storage	1.2.840.10008.5.1.4.1.1.88.67	No	Yes
Segmentation Storage	1.2.840.10008.5.1.4.1.1.66.4	No	Yes

4.2.7.2 Association Policies

4.2.7.2.1 General

The DICOM standard application context name for DICOM 3.0 is always proposed:

Table 4.2-69
DICOM APPLICATION CONTEXT FOR THE STORAGE SCP AE

Application Context Name	1.2.840.10008.3.1.1.1
--------------------------	-----------------------

4.2.7.2.2 Number of Associations

The Storage SCP AE can support up to three Associations at a time.

Table 4.2-70
NUMBER OF ASSOCIATIONS ACCEPTED FOR THE STORAGE SCP AE

Maximum number of simultaneous Associations	3
---	---

4.2.7.2.3 Asynchronous Nature

The Storage SCP AE does not support asynchronous communication (multiple outstanding transactions over a single Association).

Table 4.2-71
ASYNCHRONOUS NATURE FOR THE STORAGE SCP AE

Maximum number of outstanding asynchronous transactions	1
---	---

4.2.7.2.4 Implementation Identifying Information

The implementation information for the Storage SCP AE is:

**Table 4.2-72
DICOM IMPLEMENTATION CLASS AND VERSION FOR THE STORAGE SCP AE**

Implementation Class UID	1.2.392.200036.9116.2.6.1.100
Implementation Version Name	TM_CT_CMW_V3.00

4.2.7.3 Association Initiation Policy

The Storage SCP AE does not initiate Associations.

4.2.7.4 Association Acceptance Policy

The Storage SCP AE accepts Associations only if they have valid Presentation Contexts. If none of the requested Presentation Contexts are accepted then the Association Request itself is rejected. It can be configured to only accept Associations with certain hosts (using TCP/IP address) and/or Application Entity Titles.

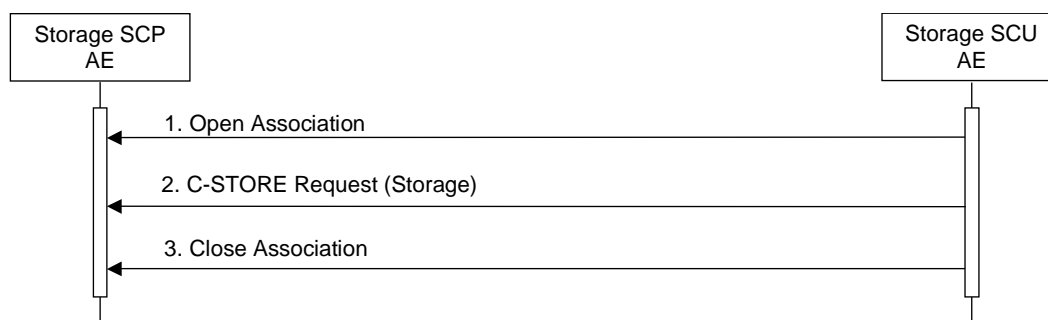

**Figure 4.2-8
SEQUENCING OF ACTIVITY – STORE IMAGES TO THE LOCAL FILE SYSTEM**

A possible sequence of interactions between the Storage SCP AE and a Storage SCU AE is illustrated in the Figure above:

1. The Storage SCU AE opens an Association with the Storage SCP AE.
2. The Storage SCU AE sends images to the Storage SCP AE using a Storage request (C-STORE) and the Storage SCP AE replies with a C-STORE response (status success).
3. The Storage SCU AE closes the Association with the Storage SCP AE.

The Storage SCP AE may reject Association attempts as shown in the Table below. The Result, Source and Reason/Diag columns represent the values returned in the corresponding fields of an ASSOCIATE-RJ PDU (see PS 3.8, Section 9.3.4). The following abbreviations are used in the Source column:

- 1 – DICOM UL service-user
- 2 – DICOM UL service-provider (ASCE related function)
- 3 – DICOM UL service-provider (Presentation related function)

**Table 4.2-73
ASSOCIATION REJECTION REASONS**

Result	Source	Reason/Diag	Explanation
2 – rejected-transient	c	2 – local-limit-exceeded	The (configurable) maximum number of simultaneous Associations has been reached. An Association request with the same parameters may succeed at a later time.
2 – rejected-transient	c	1 – temporary-congestion	No Associations can be accepted at this time due to the real-time requirements of higher priority activities (e.g. during image acquisition no Associations will be accepted) or because insufficient resources are available (e.g. memory, processes, threads). An Association request with the same parameters may succeed at a later time.
1 – rejected-permanent	a	2 – application-context-name-not-supported	The Association request contained an unsupported Application Context Name. An association request with the same parameters will not succeed at a later time.
1 – rejected-permanent	a	7 – called-AE-title-not-recognized	The Association request contained an unrecognized Called AE Title. An Association request with the same parameters will not succeed at a later time unless configuration changes are made. This rejection reason normally occurs when the Association initiator is incorrectly configured and attempts to address the Association acceptor using the wrong AE Title.
1 – rejected-permanent	a	3 – calling-AE-title-not-recognized	The Association request contained an unrecognized Calling AE Title. An Association request with the same parameters will not succeed at a later time unless configuration changes are made. This rejection reason normally occurs when the Association acceptor has not been configured to recognize the AE Title of the Association initiator.
1 – rejected-permanent	b	1 – no-reason-given	The Association request could not be parsed. An Association request with the same format will not succeed at a later time.

4.2.7.4.1.1 Accepted Presentation Contexts

The default Behavior of the Storage SCP AE supports the Implicit VR Little Endian and Explicit VR Big Endian Transfer Syntaxes.

If the both Transfer Syntaxes are proposed per Presentation Context then the Storage SCP AE will select Explicit VR Big Endian Transfer Syntax.

Any of the Presentation Contexts shown in the following table are acceptable to the Storage SCP AE.

**Table 4.2-74
ACCEPTED PRESENTATION CONTEXTS BY THE STORAGE SCP AE**

Presentation Context Table					
Abstract Syntax		Transfer Syntax		Role	Ext. Neg.
Name	UID	Name	UID		
Verification	1.2.840.10008.1.1	Implicit VR Little Endian	1.2.840.10008.1.2	SCP	None
CT Image Storage	1.2.840.10008.5.1 .4.1.1.2	Implicit VR Little Endian	1.2.840.10008.1.2	SCP	None
		Explicit VR Little Endian	1.2.840.10008.1.2.1		
		Explicit VR Big Endian	1.2.840.10008.1.2.2		
		JPEG Lossless, Non-Hierarchical,First-Order Prediction (Process 14 [Selection Value 1])	1.2.840.10008.1.2.4.70		
Secondary Capture Image Storage	1.2.840.10008.5.1 .4.1.1.7	Implicit VR Little Endian	1.2.840.10008.1.2	SCP	None
		Explicit VR Little Endian	1.2.840.10008.1.2.1		
		Explicit VR Big Endian	1.2.840.10008.1.2.2		
		JPEG Lossless, Non-Hierarchical,First-Order Prediction (Process 14 [Selection Value 1])	1.2.840.10008.1.2.4.70		
Standalone Curve Storage	1.2.840.10008.5.1 .4.1.1.9	Implicit VR Little Endian	1.2.840.10008.1.2	SCP	None
		Explicit VR Little Endian	1.2.840.10008.1.2.1		
		Explicit VR Big Endian	1.2.840.10008.1.2.2		
Enhanced CT Image Storage	1.2.840.10008.5.1 .4.1.1.2.1	Implicit VR Little Endian	1.2.840.10008.1.2	SCP	None
		Explicit VR Little Endian	1.2.840.10008.1.2.1		
		Explicit VR Big Endian	1.2.840.10008.1.2.2		
		JPEG Lossless, Non-Hierarchical,First-Order Prediction (Process 14 [Selection Value 1])	1.2.840.10008.1.2.4.70		
Grayscale Softcopy Presentation State Storage	1.2.840.10008.5.1 .4.1.1.11.1	Implicit VR Little Endian	1.2.840.10008.1.2	SCP	None
		Explicit VR Little Endian	1.2.840.10008.1.2.1		
		Explicit VR Big Endian	1.2.840.10008.1.2.2		
Enhanced SR Storage	1.2.840.10008.5.1 .4.1.1.88.22	Implicit VR Little Endian	1.2.840.10008.1.2	SCP	None
		Explicit VR Little Endian	1.2.840.10008.1.2.1		
		Explicit VR Big Endian	1.2.840.10008.1.2.2		

X-Ray Radiation Dose SR Storage	1.2.840.10008.5.1.4.1.1.88.67	Implicit VR Little Endian	1.2.840.10008.1.2	SCP	None
		Explicit VR Little Endian	1.2.840.10008.1.2.1		
		Explicit VR Big Endian	1.2.840.10008.1.2.2		
Segmentation Storage	1.2.840.10008.5.1.4.1.1.66.4	Implicit VR Little Endian	1.2.840.10008.1.2	SCP	None
		Explicit VR Little Endian	1.2.840.10008.1.2.1		
		Explicit VR Big Endian	1.2.840.10008.1.2.2		

4.2.7.4.1.2 SOP Specific Conformance for Verification SOP Class

The Storage SCP AE provides standard conformance to the Verification SOP Class as an SCP.

4.2.7.4.1.3 SOP Specific Conformance for Storage SOP Classes

The associated Activity with the Storage service is the storage of medical image data received over the network on a designated hard disk. The Storage SCP AE will return a failure status if it is unable to store the images on to the hard disk.

The Storage SCP AE is Level 0 conformant as a Storage SCP.

**Table 4.2-75
THE STORAGE SCP AE C-STORE RESPONSE STATUS RETURN REASONS**

Service Status	Further Meaning	Status Code	Reason
Success	Success	0000	The Composite SOP Instance was successfully received, verified, and stored in the system database.
Refused	Out of Resources	A700	Indicates that there was not enough local resources.
Error	Data Set does not match SOP Class	A900	Indicates that the Data Set does not encode a valid instance of the SOP Class specified.
	Cannot understand	C000	Indicates that the Storage SCP AE cannot parse the Data Set into Elements.

4.2.8 Print SCU AE Specification

4.2.8.1 SOP Classes

The Print SCU AE provides Standard Conformance to the following Meta SOP Classes:

Table 4.2-76
META SOP CLASSES FOR THE PRINT SCU AE

SOP Class Name	SOP Class UID	SCU	SCP
Basic Grayscale Print Management Meta	1.2.840.10008.5.1.1.9	Yes	No
Basic Color Print Management Meta	1.2.840.10008.5.1.1.18	Yes	No

The above Meta SOP Classes are defined by the following set of supported SOP Classes:

Table 4.2-77
SOP CLASSES FOR THE PRINT SCU AE

SOP Class Name	SOP Class UID	SCU	SCP
Basic Film Session SOP Class	1.2.840.10008.5.1.1.1	Yes	No
Basic film Box SOP Class	1.2.840.10008.5.1.1.2	Yes	No
Basic Grayscale Image Box SOP Class	1.2.840.10008.5.1.1.4	Yes	No
Basic Color Image Box SOP Class	1.2.840.10008.5.1.1.4.1	Yes	No
Printer SOP Class	1.2.840.10008.5.1.1.16	Yes	No

4.2.8.2 Association Policies

4.2.8.2.1 General

The DICOM standard application context name for DICOM 3.0 is always proposed:

Table 4.2-78
DICOM APPLICATION CONTEXT FOR THE PRINT SCU AE

Application Context Name	1.2.840.10008.3.1.1.1
--------------------------	-----------------------

4.2.8.2.2 Number of Associations

The Print SCU AE can initiate up to two Associations at a time.

Table 4.2-79
NUMBER OF ASSOCIATIONS ACCEPTED FOR THE PRINT SCU AE

Maximum number of simultaneous Associations	2
---	---

4.2.8.2.3 Asynchronous Nature

The Print SCU AE does not support asynchronous communication (multiple outstanding transactions over a single Association).

Table 4.2-80
ASYNCHRONOUS NATURE FOR THE PRINT SCU AE

Maximum number of outstanding asynchronous transactions	1
---	---

4.2.8.2.4 Implementation Identifying Information

The implementation information for the Print SCU AE is:

**Table 4.2-81
DICOM IMPLEMENTATION CLASS AND VERSION FOR THE PRINT SCU AE**

Implementation Class UID	1.2.392.200036.9116.2.6.1.100
Implementation Version Name	TM_CT_CMW_V3.00

4.2.8.3 Association Initiation Policy

4.2.8.3.1 Activity – Send Images & Print Management Information

4.2.8.3.1.1 Description and Sequencing of Activities

A user composes images onto film sheets and requests them to be sent to a specific hardcopy device. The user can select the desired film format and number of copies.

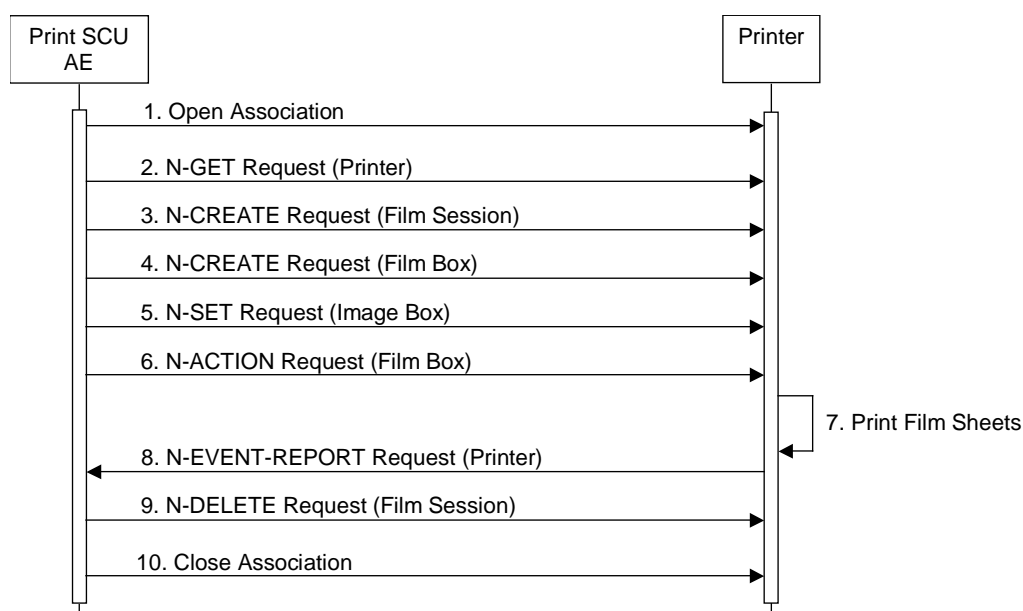

**Figure 4.2-9
SEQUENCING OF ACTIVITY – SEND IMAGES & PRINT MANAGEMENT INFORMATION**

A typical sequence of DIMSE messages sent over an association between the Print SCU AE and a Printer is illustrated in the Figure above:

1. The Print SCU AE opens an Association with the Printer.
2. N-GET on the Printer SOP Class is used to obtain current printer status information.
3. N-CREATE on the Film Session SOP Class creates a Film Session.
4. N-CREATE on the Film Box SOP Class creates a Film Box linked to the Film Session.
5. N-SET on the Image Box SOP Class transfers the contents of the film sheet to the printer.
6. N-ACTION on the Film Box SOP Class instructs the Printer to print the Film Box.
7. The Printer prints the requested number of film sheets.
8. The Printer asynchronously reports its status via N-EVENT-REPORT notification (Printer SOP Class). The printer can send this message at any time. The Print SCU AE does not require the N-EVENT-REPORT to be sent. The Print SCU AE is capable of receiving an N-EVENT-REPORT notification at any time during an association.
9. N-DELETE on the Film Session SOP Class deletes the complete Film Session SOP Instance hierarchy.
10. The Print SCU AE closes the Association with the Printer.

4.2.8.3.1.2 Proposed Presentation Contexts

The Print SCU AE is capable of proposing the Presentation Contexts shown in the Table below:

Table 4.2-82
PROPOSED PRESENTATION CONTEXTS FOR ACTIVITY
SEND IMAGES & PRINT MANAGEMENT INFORMATION

Presentation Context Table					
Abstract Syntax		Transfer Syntax		Role	Ext. Neg.
Name	UID	Name List	UID List		
Basic Grayscale Print Management Meta	1.2.840.10008.5.1.1.9	Implicit VR Little Endian	1.2.840.10008.1.2	SCU	None
		Explicit VR Big Endian	1.2.840.10008.1.2.2		
Basic Color Print Management Meta	1.2.840.10008.5.1.1.18	Implicit VR Little Endian	1.2.840.10008.1.2	SCU	None
		Explicit VR Big Endian	1.2.840.10008.1.2.2		

4.2.8.3.1.3 Common SOP Specific Conformance for all Print SOP Classes

The general behavior of the Print SCU AE during communication failure is summarized in the Table below. This behavior is common for all SOP Classes supported by the Print SCU AE.

Table 4.2-83
PRINT COMMUNICATION FAILURE BEHAVIOR

Exception	Behavior
Timeout	The Association is aborted using A-ABORT and the print-job is marked as failed. The reason is logged and the job failure is reported to the user via the job control application.
Association aborted by the SCP or network layers	The print-job is marked as failed. The reason is logged and the job failure is reported to the user via the job control application.

4.2.8.3.1.4 SOP Specific Conformance for Printer SOP Class

The Print SCU AE supports the following DIMSE operations and notifications for the Printer SOP Class:

- N-GET
- N-EVENT-REPORT

Details of the supported attributes and status handling behavior are described in the following subsections.

4.2.8.3.1.4.1 Printer SOP Class Operations (N-GET)

The Print SCU AE uses the Printer SOP Class N-GET operation to obtain information about the current printer status. The attributes obtained via N-GET are listed in the Table below:

Table 4.2-84
PRINTER SOP CLASS N-GET REQUEST ATTRIBUTES

Attribute Name	Tag	VR	Value	Presence of Value	Source
Printer Status	(2110,0010)	CS	Provided by Printer	ALWAYS	Printer
Printer Status Info	(2110,0020)	CS	Provided by Printer	ALWAYS	Printer

The Printer Status information is evaluated as follows:

1. If Printer status (2110,0010) is NORMAL, the print-job continues to be printed.
2. If Printer status (2110,0010) is FAILURE, the print-job is marked as failed. The contents of Printer Status Info (2110,0020) is logged and reported to the user via the job control application.
3. If Printer status (2110,0010) is WARNING, the print-job continues to be printed. The contents of Printer Status Info (2110,0020) is logged and reported to the user via the job control application.

The behavior of The Print SCU AE when encountering status codes in the N-GET response is summarized in the Table below:

**Table 4.2-85
PRINTER SOP CLASS N-GET RESPONSE STATUS HANDLING BEHAVIOR**

Service Status	Further Meaning	Status Code	Behavior
Success	Success	0000	The request to get printer status information was success.
*	*	Any other status code.	The Association is aborted using A-ABORT and the print-job is marked as failed. The status meaning is logged and reported to the user.

4.2.8.3.1.4.2 Printer SOP Class Notifications (N-EVENT-REPORT)

The Print SCU AE is capable of receiving the N-EVENT-REPORT request at any time during an association.

The behavior of The Print SCU AE when receiving Event Types within the N-EVENT-REPORT is summarized in the Table below:

**Table 4.2-86
PRINTER SOP CLASS N-EVENT-REPORT BEHAVIOUR**

Event Type Name	Event Type ID	Behavior
Normal	1	The print-job continues to be printed.
Warning	2	The print-job continues to be printed.
Failure	3	The print-job continues to be printed.
*	*	The print-job continues to be printed.

The reasons for returning specific status codes in the N-EVENT-REPORT response are summarized in the Table below:

**Table 4.2-87
PRINTER SOP CLASS N-EVENT-REPORT RESPONSE STATUS REASONS**

Service Status	Further Meaning	Status Code	Reasons
Success	Success	0000	The notification event has been successfully received.

4.2.8.3.1.5 SOP Specific Conformance for the Film Session SOP Class

The Print SCU AE supports the following DIMSE operations for the Film Session SOP Class:

- N-CREATE
- N-DELETE

Details of the supported attributes and status handling behavior are described in the following subsections.

4.2.8.3.1.5.1 Film Session SOP Class Operations (N-CREATE)

The attributes supplied in the N-CREATE Request are listed in the Table below:

Table 4.2-88
FILM SESSION SOP CLASS N-CREATE REQUEST ATTRIBUTES

Attribute Name	Tag	VR	Value	Presence of Value	Source
Number of Copies	(2000,0010)	IS	1 .. 99	ALWAYS	User
Print Priority	(2000,0020)	CS	MED	ALWAYS	Auto
Medium Type	(2000,0030)	CS	BLUE FILM, CLEAR FILM or PAPER	ALWAYS	User
Film Destination	(2000,0040)	CS	MAGAZINE or PROCESSOR	ALWAYS	User

The behavior of The Print SCU AE when encountering status codes in the N-CREATE response is summarized in the Table below:

Table 4.2-89
FILM SESSION SOP CLASS N-CREATE RESPONSE STATUS HANDLING BEHAVIOR

Service Status	Further Meaning	Status Code	Behavior
Success	Success	0000	The SCP has completed the operation successfully.
Warning	Attribute Value Out of Range	0116H	The N-CREATE operation is considered successful if it is configured that the status would be considered successful.
Warning	Attribute List Error	0107H	The N-CREATE operation is considered successful if it is configured that the status would be considered successful.
*	*	Any other status code.	The Association is aborted using A-ABORT and the print-job is marked as failed. The status meaning is logged and reported to the user.

4.2.8.3.1.5.2 Film Session SOP Class Operations (N-DELETE)

The behavior of The Print SCU AE when encountering status codes in a N-DELETE response is summarized in the Table below:

Table 4.2-90
PRINTER SOP CLASS N-DELETE RESPONSE STATUS HANDLING BEHAVIOR

Service Status	Further Meaning	Status Code	Behavior
Success	Success	0000	The SCP has completed the operation successfully.
*	*	Any other status code.	The Association is aborted using A-ABORT and the print-job is marked as failed. The status meaning is logged and reported to the user.

4.2.8.3.1.6 SOP Specific Conformance for the Film Box SOP Class

The Print SCU AE supports the following DIMSE operations for the Film Box SOP Class:

- N-CREATE
- N-ACTION

Details of the supported attributes and status handling behavior are described in the following subsections.

4.2.8.3.1.6.1 Film Box SOP Class Operations (N-CREATE)

The attributes supplied in the N-CREATE Request are listed in the Table below:

**Table 4.2-91
FILM BOX SOP CLASS N-CREATE REQUEST ATTRIBUTES**

Attribute Name	Tag	VR	Value	Presence of Value	Source
Image Display Format	(2010,0010)	ST	STANDARD,C,R	ALWAYS	User
Referenced Film Session Sequence	(2010,0500)	SQ		ALWAYS	Auto
>Referenced SOP Class UID	(0008,1150)	UI	1.2.840.10008.5.1.1.1	ALWAYS	Auto
>Referenced SOP Instance UID	(0008,1155)	UI	From created Film Session SOP Instance	ALWAYS	Auto
Film Orientation	(2010,0040)	CS	PORTRAIT or LANDSCAPE	ALWAYS	User
Film Size ID	(2010,0050)	CS	14INX17IN, 14INX14IN, 11INX14IN, 11INX11IN, 8INX11IN, 8INX10IN, etc.	ALWAYS	User
Magnification Type	(2010,0060)	CS	REPLICATE, BILINEAR, CUBIC or NONE	ALWAYS	User
Smoothing Type	(2010,0080)	CS		ANAP	User
Border Density	(2010,0100)	CS	BLACK or WHITE	ALWAYS	User
Empty Image Density	(2010,0110)	CS	BLACK or WHITE	ALWAYS	User
Min Density	(2010,0120)	US	0 .. 9999	ALWAYS	User
Max Density	(2010,0130)	US	0 .. 9999	ALWAYS	User
Trim	(2010,0140)	CS	YES or NO	ALWAYS	User
Configuration Information	(2010,0150)	ST		ALWAYS	Auto

The behavior of the Print SCU AE when encountering status codes in the N-CREATE response is summarized in the Table below:

Table 4.2-92
FILM BOX SOP CLASS N-CREATE RESPONSE STATUS HANDLING BEHAVIOR

Service Status	Further Meaning	Status Code	Behavior
Success	Success	0000	The SCP has completed the operation successfully.
Warning	Requested Min Density or Max Density outside of printer's operating range	B605	The N-CREATE operation is considered successful if it is configured that the status would be considered successful.
*	*	Any other status code.	The Association is aborted using A-ABORT and the print-job is marked as failed. The status meaning is logged and reported to the user.

4.2.8.3.1.6.2 Film Box SOP Class Operations (N-ACTION)

An N-ACTION Request is issued to instruct the Print SCP to print the contents of the Film Box. The Action Reply argument in the N-ACTION response is not evaluated.

The behavior of The Print SCU AE when encountering status codes in the N-ACTION response is summarized in the Table below:

**Table 4.2-93
FILM BOX SOP CLASS N-ACTION RESPONSE STATUS HANDLING BEHAVIOR**

Service Status	Further Meaning	Status Code	Behavior
Success	Success	0000	The SCP has completed the operation successfully. The film has been accepted for printing.
Warning	Film Box SOP Instance hierarchy does not contain Image Box SOP Instances (empty page)	B603	The N-ACTION operation is considered successful if it is configured that the status would be considered successful.
Warning	Image size is larger than Image Box size. The image has been demagnified.	B604	The N-ACTION operation is considered successful if it is configured that the status would be considered successful.
Warning	Image size is larger than Image Box size. The image has been cropped to fit.	B609	The N-ACTION operation is considered successful if it is configured that the status would be considered successful.
Warning	Image size or Combined Print Image Size is larger than Image Box size. The image or combined Print Image has been decimated to fit.	B60A	The N-ACTION operation is considered successful if it is configured that the status would be considered successful.
Failure	Unable to create Print Job SOP Instance; print queue is full.	C602	The Association is aborted using A-ABORT and the print-job is marked as failed. The status meaning is logged and reported to the user.
Failure	Image size is larger than Image Box size.	C603	The Association is aborted using A-ABORT and the print-job is marked as failed. The status meaning is logged and reported to the user.
Failure	Combined Print Image Size is larger than Image Box size.	C613	The Association is aborted using A-ABORT and the print-job is marked as failed. The status meaning is logged and reported to the user.
*	*	Any other status code.	The Association is aborted using A-ABORT and the print-job is marked as failed. The status meaning is logged and reported to the user.

4.2.8.3.1.7 SOP Specific Conformance for the Grayscale Image Box SOP Class

The Print SCU AE supports the following DIMSE operations for the Grayscale Image Box SOP Class:

— N-SET

Details of the supported attributes and status handling behavior are described in the following subsections.

4.2.8.3.1.7.1 Grayscale Image Box SOP Class Operations (N-SET)

The attributes supplied in the N-SET Request are listed in the Table below:

Table 4.2-94
GRAYSCALE IMAGE BOX SOP CLASS N-SET REQUEST ATTRIBUTES

Attribute Name	Tag	VR	Value	Presence of Value	Source
Image Position	(2020,0010)	US	1 .. 36	ALWAYS	Auto
Polarity	(2020,0020)	CS	NORMAL or REVERSE	ALWAYS	User
Magnification Type	(2010,0060)	CS	REPLICATE, BILINEAR, CUBIC or NONE	ALWAYS	User
Smoothing Type	(2010,0080)	CS		ANAP	User
Basic Grayscale Image Sequence	(2020,0110)	SQ		ALWAYS	Auto
>Samples Per Pixel	(0028,0002)	US	1	ALWAYS	Auto
>Photometric Interpretation	(0028,0004)	CS	MONOCHROME2	ALWAYS	Auto
>Rows	(0028,0010)	US		ALWAYS	Auto
>Columns	(0028,0011)	US		ALWAYS	Auto
>Pixel Aspect Ratio	(0028,0034)	IS	1\1	ALWAYS	Auto
>Bits Allocated	(0028,0100)	US	8	ALWAYS	Auto
>Bits Stored	(0028,0101)	US	8	ALWAYS	Auto
>High Bit	(0028,0102)	US	7	ALWAYS	Auto
>Pixel Representation	(0028,0103)	US	0	ALWAYS	Auto
>Pixel Data	(7FE0,0010)	OB		ALWAYS	Auto

The behavior of the Print SCU AE when encountering status codes in the N-SET response is summarized in the Table below:

**Table 4.2-95
GRAYSACLE IMAGE BOX SOP CLASS N-SET RESPONSE STATUS HANDLING BEHAVIOR**

Service Status	Further Meaning	Status Code	Behavior
Success	Success	0000	The SCP has completed the operation successfully. Image successfully stored in Image Box.
Warning	Image size is larger than Image Box size. The image has been demagnified.	B604	The N-SET operation is considered successful if it is configured that the status would be considered successful.
Warning	Requested Min Density or Max Density outside of printer's operating range.	B605	The N-SET operation is considered successful if it is configured that the status would be considered successful.
Warning	Image size is larger than Image Box size. The image has been cropped to fit.	B609	The N-SET operation is considered successful if it is configured that the status would be considered successful.
Warning	Image size or Combined Print Image Size is larger than Image Box size. The image or combined Print Image has been decimated to fit.	B60A	The N-SET operation is considered successful if it is configured that the status would be considered successful.
Failure	Image size is larger than Image Box size.	C603	The Association is aborted using A-ABORT and the print-job is marked as failed. The status meaning is logged and reported to the user.
Failure	Insufficient memory in printer to store the image.	C605	The Association is aborted using A-ABORT and the print-job is marked as failed. The status meaning is logged and reported to the user.
Failure	Combined Print Image Size is larger than Image Box size.	C613	The Association is aborted using A-ABORT and the print-job is marked as failed. The status meaning is logged and reported to the user.
*	*	Any other status code.	The Association is aborted using A-ABORT and the print-job is marked as failed. The status meaning is logged and reported to the user.

4.2.8.3.1.8 SOP Specific Conformance for the Color Image Box SOP Class

The Print SCU AE supports the following DIMSE operations for the Color Image Box SOP Class:

— N-SET

Details of the supported attributes and status handling behavior are described in the following subsections.

4.2.8.3.1.8.1 Color Image Box SOP Class Operations (N-SET)

The attributes supplied in the N-SET Request are listed in the Table below:

Table 4.2-96
COLOR IMAGE BOX SOP CLASS N-SET REQUEST ATTRIBUTES

Attribute Name	Tag	VR	Value	Presence of Value	Source
Image Position	(2020,0010)	US	1 .. 36	ALWAYS	Auto
Magnification Type	(2010,0060)	CS	REPLICATE, BILINEAR, CUBIC or NONE	ALWAYS	User
Smoothing Type	(2010,0080)	CS		ANAP	User
Basic Grayscale Image Sequence	(2020,0110)	SQ		ALWAYS	Auto
>Samples Per Pixel	(0028,0002)	US	3	ALWAYS	Auto
>Photometric Interpretation	(0028,0004)	CS	RGB	ALWAYS	Auto
>Planar Condition	(0028,0006)	US	0x0001	ALWAYS	Auto
>Rows	(0028,0010)	US		ALWAYS	Auto
>Columns	(0028,0011)	US		ALWAYS	Auto
>Pixel Aspect Ratio	(0028,0034)	IS	1\1	ALWAYS	Auto
>Bits Allocated	(0028,0100)	US	8	ALWAYS	Auto
>Bits Stored	(0028,0101)	US	8	ALWAYS	Auto
>High Bit	(0028,0102)	US	7	ALWAYS	Auto
>Pixel Representation	(0028,0103)	US	0	ALWAYS	Auto
>Pixel Data	(7FE0,0010)	OB		ALWAYS	Auto

The behavior of the Print SCU AE when encountering status codes in the N-SET response is summarized in the Table below:

**Table 4.2-97
COLOR IMAGE BOX SOP CLASS N-SET RESPONSE STATUS HANDLING BEHAVIOR**

Service Status	Further Meaning	Status Code	Behavior
Success	Success	0000	The SCP has completed the operation successfully. Image successfully stored in Image Box.
Warning	Image size is larger than Image Box size. The image has been demagnified.	B604	The N-SET operation is considered successful if it is configured that the status would be considered successful.
Warning	Requested Min Density or Max Density outside of printer's operating range.	B605	The N-SET operation is considered successful if it is configured that the status would be considered successful.
Warning	Image size is larger than Image Box size. The image has been cropped to fit.	B609	The N-SET operation is considered successful if it is configured that the status would be considered successful.
Warning	Image size or Combined Print Image Size is larger than Image Box size. The image or combined Print Image has been decimated to fit.	B60A	The N-SET operation is considered successful if it is configured that the status would be considered successful.
Failure	Image size is larger than Image Box size.	C603	The Association is aborted using A-ABORT and the print-job is marked as failed. The status meaning is logged and reported to the user.
Failure	Insufficient memory in printer to store the image.	C605	The Association is aborted using A-ABORT and the print-job is marked as failed. The status meaning is logged and reported to the user.
Failure	Combined Print Image Size is larger than Image Box size.	C613	The Association is aborted using A-ABORT and the print-job is marked as failed. The status meaning is logged and reported to the user.
*	*	Any other status code.	The Association is aborted using A-ABORT and the print-job is marked as failed. The status meaning is logged and reported to the user.

4.2.8.4 Association Acceptance Policy

The Print SCU AE does not accept Associations.

4.3 NETWORK INTERFACES

4.3.1 Physical Network Interface

This Product supports a single network interface. One of the following physical network interfaces will be available depending on installed hardware options:

**Table 4.3-1
SUPPORTED PHYSICAL NETWORK INTERFACES**

Ethernet 1000baseT
Ethernet 100baseT
Ethernet 10baseT

4.3.2 Additional Protocols

None.

4.4 CONFIGURATION

4.4.1 AE Title/Presentation Address Mapping

4.4.1.1 Local AE Titles

All local applications use the AE Titles and TCP/IP Ports configured via the Service/Installation Tool. The Field Service Engineer can configure the TCP Port via the Service/Installation Tool.

**Table 4.4-1
AE TITLE CONFIGURATION TABLE**

Application Entity	Default AE Title	Default TCP/IP Port
MWM SCU	TM_CT_CMW_V3.00	Not Applicable
MPPS SCU		
Q/R SCU		
Print SCU		
Storage SCU		2700
Storage SCP		
Q/R SCP		
Storage Commitment SCU		

4.4.1.2 Remote AE Title/Presentation Address Mapping

The AE Titles, host names and port numbers of remote applications are configured using the Service/Installation Tool.

4.4.2 Parameters

A large number of parameters related to acquisition and general operation can be configured using the Service/Installation Tool. The Table below only shows those configuration parameters relevant to DICOM communication. See the Product's Service Manual for details on general configuration capabilities.

**Table 4.4-2
CONFIGURATION PARAMETERS TABLE**

Parameter	Configurable (Yes/No) [Range]	Default Value
General Parameters		
Max PDU Receive Size	Yes	16 Kbytes
Max PDU Send Size	[1-999999]	
Time-out waiting for a acceptance or rejection response to an Association Request (Application Level Timeout)	Yes [1-999999]	30 Sec
Time-out waiting for a response to an Association release request (Application Level Timeout)	Yes [1-999999]	15 sec
Time-out waiting for completion of a TCP/IP connect request (Low-level timeout)	Yes [1-999999]	15 sec
Time-out awaiting a Response to a DIMSE Request (Low-Level Timeout)	Yes [1-999999]	15 sec
Time-out for waiting for data between TCP/IP-packets (Low Level Timeout)	Yes [1-999999]	15 sec
Storage SCU Parameters		
Storage SCU time-out waiting for a response to a C-STORE-RQ	Yes [1-999999]	180sec
Number of times a failed send job may be retried	No	Forever, until the job succeeds or user deletes the job.
Delay between retrying failed send jobs	No	60sec
Maximum number of simultaneously initiated Associations by the Storage SCU AE	No	2
Supported Transfer Syntaxes (separately configurable for each remote AE)	Yes	Implicit VR Little Endian
Behavior when receiving the Warning "Coercion of Data Elements" as service status.	Yes [Considered as Success or Failure]	Considered as Failure
Behavior when receiving the Warning "Data Set does not match SOP Class" as service status.	Yes [Considered as Success or Failure]	Considered as Failure
Behavior when receiving the Warning "Elements Discarded" as service status.	Yes [Considered as Success or Failure]	Considered as Failure

Storage Commitment SCU Parameters		
Storage Commitment SCU time-out waiting for a response to a N-ACTION-RQ	Yes [1-999999]	180 Sec
Maximum number of simultaneously initiated Associations by the Storage Commitment SCU AE	No	1
Timeout waiting for a Storage Commitment Notification (maximum duration of applicability for a Storage Commitment Transaction UID).	Yes [1-1728]	72Hours
Maximum number of simultaneously accepted Associations by the Storage Commitment SCU AE	No	3
Delay association release after sending a Storage Commitment Request (wait for a Storage Commitment Notification over the same association).	No	0
Behavior when receiving N-EVENT Report - the Storage Commitment Request Successful.	No	The committed mark is set to the corresponding data in the local database. The database browser shows the mark.
Q/R SCP parameters		
Maximum number of simultaneously accepted Associations by the Q/R SCP AE	No	3
Modality Worklist SCU Parameters		
Modality Worklist SCU time-out waiting for the final response to a C-FIND-RQ	Yes [1-999999]	180sec
Maximum number of simultaneously initiated Associations by the MWM SCU AE	No	1
MPPS SCU Parameters		
MPPS SCU time-out waiting for a response to a N-CREATE-RQ	Yes [1-999999]	180sec
MPPS SCU time-out waiting for a response to a N-SET-RQ	Yes [1-999999]	180sec
MPPS SCU time-out waiting for a response to a N-GET-RQ	Yes [1-999999]	180sec
Maximum number of simultaneously initiated Associations by the MPPS SCU AE	No	1
Supported Transfer Syntaxes for MPPS	Yes	Implicit VR Little Endian
Behavior when receiving the Warning "Attribute Value Out of Range" as service status.	Yes [Considered as Success or Failure]	Considered as Failure
Storage SCP parameters		
Maximum number of simultaneously accepted Associations by the Storage SCP AE	No	3

Print SCU Parameters		
Print SCU time-out waiting for a response to a N-GET-RQ	Yes [1-999999]	180sec
Print SCU time-out waiting for a response to a N-CREATE-RQ	Yes [1-999999]	180sec
Print SCU time-out waiting for a response to a N-SET-RQ	Yes [1-999999]	180sec
Print SCU time-out waiting for a response to a N-ACTION-RQ	Yes [1-999999]	180sec
Maximum number of simultaneously initiated Associations by the Print SCU AE	No	1
Supported Transfer Syntaxes (separately configurable for each remote printer)	Yes	Implicit VR Little Endian
Behavior when receiving the Warning "Attribute Value Out of Range" as service status of the Film Session N-CREATE.	Yes [Considered as Success or Failure]	Considered as Failure
Behavior when receiving the Warning "Attribute List Error" as service status of the Film Session N-CREATE.	Yes [Considered as Success or Failure]	Considered as Failure
Behavior when receiving the Warning "Requested Min Density or Max Density outside of printer's operating range" as service status of the Film Box N-CREATE.	Yes [Considered as Success or Failure]	Considered as Failure
Behavior when receiving the Warning "Film Box SOP Instance hierarchy does not contain Image Box SOP Instances (empty page)" as service status of the Film Box N-ACTION.	Yes [Considered as Success or Failure]	Considered as Failure
Behavior when receiving the Warning "Image size is larger than Image Box size. The image has been demagnified." as service status of the Film Box N-ACTION.	Yes [Considered as Success or Failure]	Considered as Failure
Behavior when receiving the Warning "Image size is larger than Image Box size. The image has been cropped to fit." as service status of the Film Box N-ACTION.	Yes [Considered as Success or Failure]	Considered as Failure
Behavior when receiving the Warning "Image size or Combined Print Image Size is larger than Image Box size. The image or combined Print Image has been decimated to fit." as service status of the Film Box N-ACTION.	Yes [Considered as Success or Failure]	Considered as Failure
Behavior when receiving the Warning "Image size is larger than Image Box size. The image has been demagnified." as service status of the Grayscale Image Box N-SET.	Yes [Considered as Success or Failure]	Considered as Failure

Behavior when receiving the Warning "Requested Min Density or Max Density outside of printer's operating range." as service status of the Grayscale Image Box N-SET.	Yes [Considered as Success or Failure]	Considered as Failure
Behavior when receiving the Warning "Image size is larger than Image Box size. The image has been cropped to fit." as service status of the Grayscale Image Box N-SET.	Yes [Considered as Success or Failure]	Considered as Failure
Behavior when receiving the Warning "Image size or Combined Print Image Size is larger than Image Box size. The image or combined Print Image has been decimated to fit." as service status of the Grayscale Image Box N-SET.	Yes [Considered as Success or Failure]	Considered as Failure
Behavior when receiving the Warning "Image size is larger than Image Box size. The image has been demagnified." as service status of the Color Image Box N-SET.	Yes [Considered as Success or Failure]	Considered as Failure
Behavior when receiving the Warning "Requested Min Density or Max Density outside of printer's operating range." as service status of the Color Image Box N-SET.	Yes [Considered as Success or Failure]	Considered as Failure
Behavior when receiving the Warning "Image size is larger than Image Box size. The image has been cropped to fit." as service status of the Color Image Box N-SET.	Yes [Considered as Success or Failure]	Considered as Failure
Behavior when receiving the Warning "Image size or Combined Print Image Size is larger than Image Box size. The image or combined Print Image has been decimated to fit." as service status of the Color Image Box N-SET.	Yes [Considered as Success or Failure]	Considered as Failure

5. MEDIA INTERCHANGE

5.1 IMPLEMENTATION MODEL

5.1.1 Application Data Flow

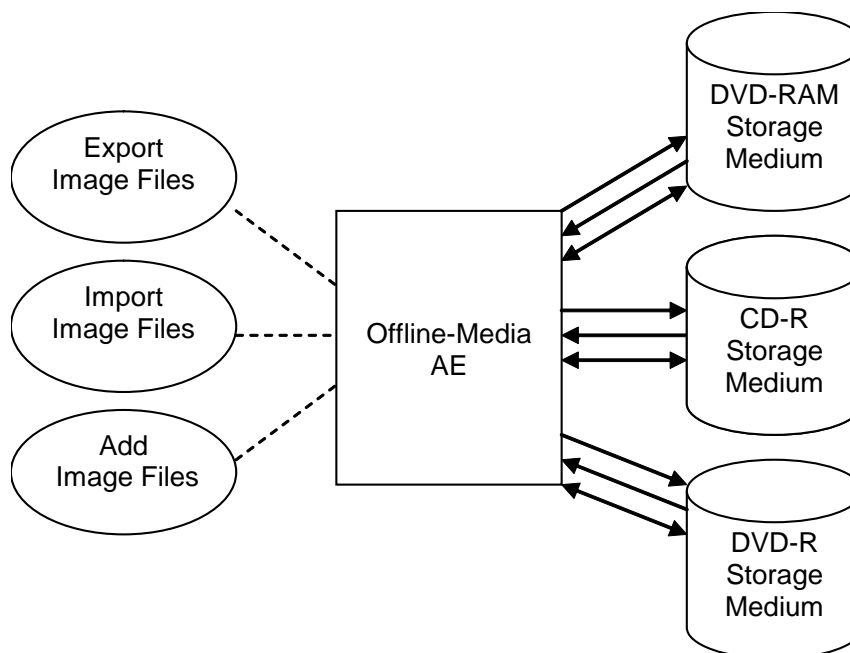

Figure 5.1-1
APPLICATION DATA FLOW DIAGRAM FOR MEDIA STORAGE

- The Offline-Media AE exports image files to a CD-R, a DVD-R or a DVD-RAM Storage medium. It is associated with the local real-world activity “Export Image Files” performed upon user request.
- The Offline-Media AE imports image files from a CD-R, a DVD-R or a DVD-RAM Storage medium. It is associated with the local real-world activity “Import Image Files” performed upon user request.
- The Offline-Media AE updates image files on a CD-R, a DVD-R or a DVD-RAM Storage medium. It is associated with the local real-world activity “Add Image Files” performed upon user request.

5.1.2 Functional Definition of AEs

5.1.2.1 Functional Definition of Offline-Media AE

The Offline-Media AE is performed upon user request for selected studies /series/images to/from an offline DICOM CD-R, DVD-R or DVD-RAM medium. It therefore performs the following tasks:

Export:

- Builds DICOM Information Objects.
- Creates a DICOMDIR file that represents the contents of the DICOM Information Objects to be recorded.
- Records DICOM Information Objects and the DICOMDIR file to the CD-R, the DVD-R or the DVD-RAM medium.

Import:

- Reads the DICOMDIR file that represents the contents of the data as recorded.
- Displays the ordered list of studies/series/images, identifying information.

- Loads the selected studies/series/images from the CD-R, the DVD-R or the DVD-RAM medium and displays them on the screen.

Addition:

- Reads a File-set of the CD-R, the DVD-R or the DVD-RAM medium and writes it to the local storage device.
- Adds the studies/series/images to the File-Set, then writes it to the medium.
- Modifies the DICOMDIR file.

Note: The Offline-Media AE can update files created by the product itself.

5.1.3 Sequencing of Real-World Activities

5.1.3.1 Activity - Export Image Files

5.1.3.1.1 Activity-Export Image Files to CD-R

Operator requests to create new File-set(s) onto a new CD-R. The requests are placed in a queue and are executed in the background.

The operations for “Export Image Files” are described below:

- Step-1: Select the instance(s), series or studies on the local storage device to be created to the CD-R medium.
- Step-2: Select the image archiving.
- Step-3: Select the Virtual Cash Disk as a destination.
- Step-4: Request to copy to the CD-R.

5.1.3.1.2 Activity-Export Image Files to DVD-R

Operator requests to create new File-set(s) onto a new DVD-R. The requests are placed in a queue and are executed in the background.

The operations for “Export Image Files” are described below:

- Step-1: Select the instance(s), series or studies on the local storage device to be created to the DVD-R medium.
- Step-2: Select the image archiving.
- Step-3: Select the Virtual Cash Disk as a destination.
- Step-4: Request to copy to the DVD-R.

5.1.3.1.3 Activity-Export Image Files to DVD-RAM

Operator requests to create File-set(s) onto a new DVD-RAM. The requests are placed in a queue and are executed in the background.

The operations for “Export Image Files” are described below:

- Step-1: Select the instance(s), series or studies on the local storage device to be created to the DVD-RAM medium.
- Step-2: Select the image archiving.
- Step-3: Select the DVD-RAM device as a destination.
- Step-4: Request to copy to the DVD-RAM.

5.1.3.2 Activity - Import Image Files

Operator requests to retrieve File-set(s) on the CD-R, the DVD-R or the DVD-RAM. The requests are placed in a queue and are executed in the background.

The operations for “Import Image Files” are described below:

- Step-1: Select the CT image(s), SC image(s) and/or Standalone Curve information(s), series or studies on the medium to be retrieved to the local storage device.
- Step-2: Select the data retrieval.
- Step-3: Select the local storage device as a destination.

5.1.3.3 Activity – Add Image Files

5.1.3.3.1 Activity-Add Image Files to CD-R

Operator requests to add new objects to an already existing File-set on the CD-R. The requests are placed in a queue and are executed in the background.

The operations for “Add Image Files” are described below:

- Step-1: Select the instance(s), series or studies on the local storage device to be added to the CD-R medium.
- Step-2: Select the image archiving.
- Step-3: Select the Virtual Cash Disk as a destination.
- Step-4: Request to copy to the CD-R.

5.1.3.3.2 Activity-Add Image Files to DVD-R

Operator requests to add new objects to an already existing File-set on the DVD-R. The requests are placed in a queue and are executed in the background.

The operations for “Add Image Files” are described below:

- Step-1: Select the instance(s), series or studies on the local storage device to be added to the DVD-R medium.
- Step-2: Select the image archiving.
- Step-3: Select the Virtual Cash Disk as a destination.
- Step-4: Request to copy to the DVD-R.

5.1.3.3.3 Activity-Add Image Files to DVD-RAM

Operator requests to add new objects to an already existing File-set on the DVD-RAM. The requests are placed in a queue and are executed in the background.

The operations for “Add Image Files” are described below:

- Step-1: Select the instance(s), series or studies on the local storage device to be added to the DVD-RAM medium.
- Step-2: Select the image archiving.
- Step-3: Select the DVD-RAM device as a destination.
- Step-4: Request to copy to the DVD-RAM.

5.1.4 File Meta Information for Implementation Class and Version

The implementation information written to the File Meta Header in each file is:

**Table 5.1-1
DICOM IMPLEMENTATION CLASS AND VERSION FOR MEDIA STORAGE**

File Meta Information Version	1
Implementation Class UID	1.2.392.200036.9116.2.6.1.100
Implementation Version Name	TM_CT_CMW_V3.00

5.2 AE SPECIFICATIONS

5.2.1 Offline-Media AE Specification

The Offline-Media AE provides standard conformance to the DICOM Interchange Option of the Media Storage Service Class. The Application Profiles and roles are listed below:

**Table 5.2-1
APPLICATION PROFILES, ACTIVITIES AND ROLES FOR OFFLINE-MEDIA**

Application Profiles Supported	Real World Activity	Role	SC Option
STD-CTMR-CD, STD-CTMR-DVD-RAM, STD-GEN-CD, STD-GEN-DVD-JPEG, STD-GEN-DVD-RAM, DED-CT-CD, DED-CT-DVD, DED-CT-DVD-RAM	Export Image Files	FSC	Interchange
STD-GEN-CD, STD-GEN-DVD-RAM, DED-CT-CD, DED-CT-DVD, DED-CT-DVD-RAM	Add Image Files	FSU	Interchange
STD-GEN-CD, STD-GEN-DVD-JPEG, STD-GEN-DVD-RAM, DED-CT-CD, DED-CT-DVD, DED-CT-DVD-RAM	Import Image Files	FSR	Interchange

5.2.1.1 File Meta Information for the Application Entity

The Offline-Media AE does not set the Source Application Entity Title.

5.2.1.2 Real-World Activities

5.2.1.2.1 Activity – Export Image Files

The Offline-Media AE acts as an FSC using the interchange option when requested to export SOP Instances from the local database to a CD-R, a DVD-R or a DVD-RAM medium.

5.2.1.2.1.1 Media Storage Application Profiles

The Offline-Media AE supports the STD-CTMR-CD, the STD-CTMR-DVD-RAM, the STD-GEN-CD, the STD-GEN-DVD-JPEG, the STD-GEN-DVD-RAM, the DED-CT-CD, the DED-CT-DVD and the DED-CT-DVD-RAM Application Profile.

5.2.1.2.1.1.1 Options

The Offline-Media AE supports the SOP Classes and Transfer Syntaxes listed in the Table below for the STD-CTMR-CD, the STD-CTMR-DVD-RAM Application Profile as an FSC.

Table 5.2-2
IODS, SOP CLASSES AND TRANSFER SYNTAXES FOR THE STD-CTMR-CD AND THE
STD-CTMR-DVD-RAM PROFILE (FSC)

Information Object Definition	SOP Class UID	Transfer Syntax	Transfer Syntax UID
Media Storage Directory Storage	1.2.840.10008.1.3.10	Explicit VR Little Endian Uncompressed	1.2.840.10008.1.2.1
CT Image Storage	1.2.840.10008.5.1.4.1.1.2	Explicit VR Little Endian Uncompressed	1.2.840.10008.1.2.1
CT Image Storage	1.2.840.10008.5.1.4.1.1.2	JPEG Lossless, Non-Hierarchical, First-Order Prediction (Process 14 [Selection Value 1])*	1.2.840.10008.1.2.4.70
Secondary Capture Image Storage (Grayscale)	1.2.840.10008.5.1.4.1.1.7	Explicit VR Little Endian Uncompressed	1.2.840.10008.1.2.1
Secondary Capture Image Storage (Grayscale)	1.2.840.10008.5.1.4.1.1.7	JPEG Lossless, Non-Hierarchical, First-Order Prediction (Process 14 [Selection Value 1])*	1.2.840.10008.1.2.4.70

*: The JPEG Transfer Syntax is not supported for the STD-CTMR-DVD-RAM.

The Offline-Media AE supports the SOP Classes and Transfer Syntaxes listed in the Table below for the STD-GEN-CD, STD-GEM-DVD-JPEG and the STD-GEN-DVD-RAM Application Profile as an FSC.

Table 5.2-3

IODS, SOP CLASSES AND TRANSFER SYNTAXES FOR THE STD-GEN-CD, THE STD-GEN-DVD-JPEG AND THE STD-GEN-DVD-RAM PROFILE (FSC)

Information Object Definition	SOP Class UID	Transfer Syntax	Transfer Syntax UID
Media Storage Directory Storage	1.2.840.10008.1.3.10	Explicit VR Little Endian Uncompressed	1.2.840.10008.1.2.1
CT Image Storage	1.2.840.10008.5.1.4.1.1.2	Explicit VR Little Endian Uncompressed	1.2.840.10008.1.2.1
CT Image Storage	1.2.840.10008.5.1.4.1.1.2	JPEG Lossless, Non-Hierarchical, First-Order Prediction (Process 14 [Selection Value 1])*	1.2.840.10008.1.2.4.70
Secondary Capture Image Storage (Grayscale)	1.2.840.10008.5.1.4.1.1.7	Explicit VR Little Endian Uncompressed	1.2.840.10008.1.2.1
Secondary Capture Image Storage (Grayscale)	1.2.840.10008.5.1.4.1.1.7	JPEG Lossless, Non-Hierarchical, First-Order Prediction (Process 14 [Selection Value 1])*	1.2.840.10008.1.2.4.70
Secondary Capture Image Storage (Color, RGB)	1.2.840.10008.5.1.4.1.1.7	Explicit VR Little Endian Uncompressed	1.2.840.10008.1.2.1
Secondary Capture Image Storage (Color, RGB)	1.2.840.10008.5.1.4.1.1.7	JPEG Lossless, Non-Hierarchical, First-Order Prediction (Process 14 [Selection Value 1])*	1.2.840.10008.1.2.4.70
Standalone Curve Storage	1.2.840.10008.5.1.4.1.1.9	Explicit VR Little Endian Uncompressed	1.2.840.10008.1.2.1
Enhanced CT Image Storage	1.2.840.10008.5.1.4.1.1.2.1	Explicit VR Little Endian Uncompressed	1.2.840.10008.1.2.1
Grayscale Softcopy Presentation State Storage	1.2.840.10008.5.1.4.1.1.11.1	Explicit VR Little Endian Uncompressed	1.2.840.10008.1.2.1
Enhanced SR Storage	1.2.840.10008.5.1.4.1.1.88.22	Explicit VR Little Endian Uncompressed	1.2.840.10008.1.2.1
X-Ray Radiation Dose SR Storage	1.2.840.10008.5.1.4.1.1.88.67	Explicit VR Little Endian Uncompressed	1.2.840.10008.1.2.1

*: The JPEG Transfer Syntax is not supported for the STD-GEN-DVD-RAM.

The Offline-Media AE supports the SOP Classes and Transfer Syntaxes listed in the Table below for the DED-CT-CD, DED-CT-DVD and the DED-CT-DVD-RAM Application Profile as an FSC.

Table 5.2-4

IODS, SOP CLASSES AND TRANSFER SYNTAXES FOR THE DED-CT-CD, THE DED-CT-DVD AND THE DED-CT-DVD-RAM PROFILE (FSC)

Information Object Definition	SOP Class UID	Transfer Syntax	Transfer Syntax UID
Media Storage Directory Storage	1.2.840.10008.1.3.10	Explicit VR Little Endian Uncompressed	1.2.840.10008.1.2.1
CT Image Storage	1.2.840.10008.5.1.4.1.1.2	Explicit VR Little Endian Uncompressed	1.2.840.10008.1.2.1
CT Image Storage	1.2.840.10008.5.1.4.1.1.2	JPEG Lossless, Non-Hierarchical, First-Order Prediction (Process 14 [Selection Value 1])*	1.2.840.10008.1.2.4.70
Secondary Capture Image Storage (Grayscale)	1.2.840.10008.5.1.4.1.1.7	Explicit VR Little Endian Uncompressed	1.2.840.10008.1.2.1
Secondary Capture Image Storage (Grayscale)	1.2.840.10008.5.1.4.1.1.7	JPEG Lossless, Non-Hierarchical, First-Order Prediction (Process 14 [Selection Value 1])*	1.2.840.10008.1.2.4.70
Secondary Capture Image Storage (Color, RGB)	1.2.840.10008.5.1.4.1.1.7	Explicit VR Little Endian Uncompressed	1.2.840.10008.1.2.1
Secondary Capture Image Storage (Color, RGB)	1.2.840.10008.5.1.4.1.1.7	JPEG Lossless, Non-Hierarchical, First-Order Prediction (Process 14 [Selection Value 1])*	1.2.840.10008.1.2.4.70
Standalone Curve Storage	1.2.840.10008.5.1.4.1.1.9	Explicit VR Little Endian Uncompressed	1.2.840.10008.1.2.1
Enhanced CT Image Storage	1.2.840.10008.5.1.4.1.1.2.1	Explicit VR Little Endian Uncompressed	1.2.840.10008.1.2.1
Grayscale Softcopy Presentation State Storage	1.2.840.10008.5.1.4.1.1.11.1	Explicit VR Little Endian Uncompressed	1.2.840.10008.1.2.1
Enhanced SR Storage	1.2.840.10008.5.1.4.1.1.88.22	Explicit VR Little Endian Uncompressed	1.2.840.10008.1.2.1
X-Ray Radiation Dose SR Storage	1.2.840.10008.5.1.4.1.1.88.67	Explicit VR Little Endian Uncompressed	1.2.840.10008.1.2.1
TOSHIBA CT Non-Image Storage	1.2.392.200036.9116.2.6.1.1	Explicit VR Little Endian Uncompressed	1.2.840.10008.1.2.1

*: The JPEG Transfer Syntax is not supported for the DED-CT-DVD-RAM.

5.2.1.2.2 Activity – Import Image Files

The Offline-Media AE acts as an FSR using the interchange option when requested to import SOP Instances from a CD-R, a DVD-R or a DVD-RAM medium to the local database.

5.2.1.2.2.1 Media Storage Application Profiles

The Offline-Media AE supports the STD-GEN-CD, the STD-GEN-DVD-JPEG, the STD-GEN-DVD-RAM the DED-CT-CD, the DED-CT-DVD and the DED-CT-DVD-RAM Application Profile.

5.2.1.2.2.1.1 Options

The Offline-Media AE supports the SOP Classes and Transfer Syntaxes listed in the Table below for the STD-GEN-CD, and STD-GEN-DVD-JPEG and the STD-GEN-DVD-RAM Application Profile as an FSR.

Table 5.2-5

IODS, SOP CLASSES AND TRANSFER SYNTAXES FOR THE STD-GEN-CD, THE STD-GEN-DVD-JPEG AND THE STD-GEN-DVD-RAM PROFILE (FSR)

Information Object Definition	SOP Class UID	Transfer Syntax	Transfer Syntax UID
Media Storage Directory Storage	1.2.840.10008.1.3.10	Explicit VR Little Endian Uncompressed	1.2.840.10008.1.2.1
CT Image Storage	1.2.840.10008.5.1.4.1.1.2	Implicit VR Little Endian Uncompressed	1.2.840.10008.1.2
CT Image Storage	1.2.840.10008.5.1.4.1.1.2	Explicit VR Little Endian Uncompressed	1.2.840.10008.1.2.1
CT Image Storage	1.2.840.10008.5.1.4.1.1.2	JPEG Lossless, Non-Hierarchical, First-Order Prediction (Process 14 [Selection Value 1])	1.2.840.10008.1.2.4.70
Secondary Capture Image Storage (Grayscale)	1.2.840.10008.5.1.4.1.1.7	Explicit VR Little Endian Uncompressed	1.2.840.10008.1.2.1
Secondary Capture Image Storage (Grayscale)	1.2.840.10008.5.1.4.1.1.7	Implicit VR Little Endian Uncompressed	1.2.840.10008.1.2
Secondary Capture Image Storage (Grayscale)	1.2.840.10008.5.1.4.1.1.7	JPEG Lossless, Non-Hierarchical, First-Order Prediction (Process 14 [Selection Value 1])	1.2.840.10008.1.2.4.70
Secondary Capture Image Storage (Color, RGB)	1.2.840.10008.5.1.4.1.1.7	Explicit VR Little Endian Uncompressed	1.2.840.10008.1.2.1

Secondary Capture Image Storage (Color, RGB)	1.2.840.10008.5.1.4.1.1.7	Implicit VR Little Endian Uncompressed	1.2.840.10008.1.2
Secondary Capture Image Storage (Color, RGB)	1.2.840.10008.5.1.4.1.1.7	JPEG Lossless, Non-Hierarchical, First-Order Prediction (Process 14 [Selection Value 1])	1.2.840.10008.1.2. 4.70
Standalone Curve Storage	1.2.840.10008.5.1.4.1.1.9	Explicit VR Little Endian Uncompressed	1.2.840.10008.1.2. 1
Standalone Curve Storage	1.2.840.10008.5.1.4.1.1.9	Implicit VR Little Endian Uncompressed	1.2.840.10008.1.2
Enhanced CT Image Storage	1.2.840.10008.5.1.4.1.1.2.1	Explicit VR Little Endian Uncompressed	1.2.840.10008.1.2. 1
Grayscale Softcopy Presentation State Storage	1.2.840.10008.5.1.4.1.1.11.1	Explicit VR Little Endian Uncompressed	1.2.840.10008.1.2. 1
Enhanced SR Storage	1.2.840.10008.5.1.4.1.1.88.2 2	Explicit VR Little Endian Uncompressed	1.2.840.10008.1.2. 1
X-Ray Radiation Dose SR Storage	1.2.840.10008.5.1.4.1.1.88.6 7	Explicit VR Little Endian Uncompressed	1.2.840.10008.1.2. 1

Note:

The Offline-Media AE can import Enhanced CT Image Object exported by the Offline-Media AE.

The Offline-Media AE supports the SOP Classes and Transfer Syntaxes listed in the Table below for the DED-CT-CD, DED-CT-DVD and the DED-CT-DVD-RAM Application Profile as an FSR.

Table 5.2-6

IODS, SOP CLASSES AND TRANSFER SYNTAXES FOR THE DED-CT-CD, THE DED-CT-DVD AND THE DED-CT-DVD-RAM PROFILE (FSR)

Information Object Definition	SOP Class UID	Transfer Syntax	Transfer Syntax UID
Media Storage Directory Storage	1.2.840.10008.1.3.10	Explicit VR Little Endian Uncompressed	1.2.840.10008.1.2.1
CT Image Storage	1.2.840.10008.5.1.4.1.1.2	Implicit VR Little Endian Uncompressed	1.2.840.10008.1.2
CT Image Storage	1.2.840.10008.5.1.4.1.1.2	Explicit VR Little Endian Uncompressed	1.2.840.10008.1.2.1
CT Image Storage	1.2.840.10008.5.1.4.1.1.2	JPEG Lossless, Non-Hierarchical, First-Order Prediction (Process 14 [Selection Value 1])	1.2.840.10008.1.2.4.70
Secondary Capture Image Storage (Grayscale)	1.2.840.10008.5.1.4.1.1.7	Explicit VR Little Endian Uncompressed	1.2.840.10008.1.2.1
Secondary Capture Image Storage (Grayscale)	1.2.840.10008.5.1.4.1.1.7	Implicit VR Little Endian Uncompressed	1.2.840.10008.1.2
Secondary Capture Image Storage (Grayscale)	1.2.840.10008.5.1.4.1.1.7	JPEG Lossless, Non-Hierarchical, First-Order Prediction (Process 14 [Selection Value 1])	1.2.840.10008.1.2.4.70
Secondary Capture Image Storage (Color, RGB)	1.2.840.10008.5.1.4.1.1.7	Explicit VR Little Endian Uncompressed	1.2.840.10008.1.2.1
Secondary Capture Image Storage (Color, RGB)	1.2.840.10008.5.1.4.1.1.7	Implicit VR Little Endian Uncompressed	1.2.840.10008.1.2
Secondary Capture Image Storage (Color, RGB)	1.2.840.10008.5.1.4.1.1.7	JPEG Lossless, Non-Hierarchical, First-Order Prediction (Process 14 [Selection Value 1])	1.2.840.10008.1.2.4.70

Standalone Curve Storage	1.2.840.10008.5.1.4.1.1.9	Explicit VR Little Endian Uncompressed	1.2.840.10008.1.2.1
Standalone Curve Storage	1.2.840.10008.5.1.4.1.1.9	Implicit VR Little Endian Uncompressed	1.2.840.10008.1.2
Enhanced CT Image Storage	1.2.840.10008.5.1.4.1.1.2.1	Explicit VR Little Endian Uncompressed	1.2.840.10008.1.2.1
Grayscale Softcopy Presentation State Storage	1.2.840.10008.5.1.4.1.1.11.1	Explicit VR Little Endian Uncompressed	1.2.840.10008.1.2.1
Enhanced SR Storage	1.2.840.10008.5.1.4.1.1.88.22	Explicit VR Little Endian Uncompressed	1.2.840.10008.1.2.1
X-Ray Radiation Dose SR Storage	1.2.840.10008.5.1.4.1.1.88.67	Explicit VR Little Endian Uncompressed	1.2.840.10008.1.2.1
TOSHIBA CT Non-Image Storage	1.2.392.200036.9116.2.6.1.1	Explicit VR Little Endian Uncompressed	1.2.840.10008.1.2.1

Note:

The Offline-Media AE can import Enhanced CT Image Object exported by the Offline-Media AE.

5.2.1.2.3 Activity – Add Image Files

The Offline-Media AE acts as an FSU using the interchange option when requested to add SOP Instances to a CD-R, a DVD-R or a DVD-RAM medium.

5.2.1.2.3.1 Media Storage Application Profiles

The Offline-Media AE supports the STD-GEN-CD, the STD-GEN-DVD-RAM, the DED-CT-CD, the DED-CT-DVD and the DED-CT-DVD-RAM Application Profile.

5.2.1.2.3.1.1 Options

The Offline-Media AE supports the SOP Classes and Transfer Syntaxes listed in the Table below for the STD-GEN-CD and STD-GEN-DVD-RAM Application Profile as an FSU.

Table 5.2-7
IODS, SOP CLASSES AND TRANSFER SYNTAXES FOR THE STD-GEN-CD AND THE
STD-GEN-DVD-RAM PROFILE (FSU)

Information Object Definition	SOP Class UID	Transfer Syntax	Transfer Syntax UID
Media Storage Directory Storage	1.2.840.10008.1.3.10	Explicit VR Little Endian Uncompressed	1.2.840.10008.1.2.1
CT Image Storage	1.2.840.10008.5.1.4.1.1.2	Explicit VR Little Endian Uncompressed	1.2.840.10008.1.2.1
CT Image Storage	1.2.840.10008.5.1.4.1.1.2	JPEG Lossless, Non-Hierarchical, First-Order Prediction (Process 14 [Selection Value 1])*	1.2.840.10008.1.2.4.70
Secondary Capture Image Storage (Grayscale)	1.2.840.10008.5.1.4.1.1.7	Explicit VR Little Endian Uncompressed	1.2.840.10008.1.2.1
Secondary Capture Image Storage (Grayscale)	1.2.840.10008.5.1.4.1.1.7	JPEG Lossless, Non-Hierarchical, First-Order Prediction (Process 14 [Selection Value 1])*	1.2.840.10008.1.2.4.70
Secondary Capture Image Storage (Color, RGB)	1.2.840.10008.5.1.4.1.1.7	Explicit VR Little Endian Uncompressed	1.2.840.10008.1.2.1
Secondary Capture Image Storage (Color, RGB)	1.2.840.10008.5.1.4.1.1.7	JPEG Lossless, Non-Hierarchical, First-Order Prediction (Process 14 [Selection Value 1])*	1.2.840.10008.1.2.4.70
Standalone Curve Storage	1.2.840.10008.5.1.4.1.1.9	Explicit VR Little Endian Uncompressed	1.2.840.10008.1.2.1
Enhanced CT Image Storage	1.2.840.10008.5.1.4.1.1.2.1	Explicit VR Little Endian Uncompressed	1.2.840.10008.1.2.1
Grayscale Softcopy Presentation State Storage	1.2.840.10008.5.1.4.1.1.11.1	Explicit VR Little Endian Uncompressed	1.2.840.10008.1.2.1
Enhanced SR Storage	1.2.840.10008.5.1.4.1.1.88.22	Explicit VR Little Endian Uncompressed	1.2.840.10008.1.2.1
X-Ray Radiation Dose SR Storage	1.2.840.10008.5.1.4.1.1.88.67	Explicit VR Little Endian Uncompressed	1.2.840.10008.1.2.1

*: The JPEG Transfer Syntax is not supported for the STD-GEN-DVD-RAM.

The Offline-Media AE supports the SOP Classes and Transfer Syntaxes listed in the Table below for the DED-CT-CD, the DED-CT-DVD and DED-CT-DVD-RAM Application Profile as an FSU.

Table 5.2-8

IODS, SOP CLASSES AND TRANSFER SYNTAXES FOR THE DED-CT-CD, THE DED-CT-DVD AND THE DED-CT-DVD-RAM PROFILE (FSU)

Information Object Definition	SOP Class UID	Transfer Syntax	Transfer Syntax UID
Media Storage Directory Storage	1.2.840.10008.1.3.10	Explicit VR Little Endian Uncompressed	1.2.840.10008.1.2.1
CT Image Storage	1.2.840.10008.5.1.4.1.1.2	Explicit VR Little Endian Uncompressed	1.2.840.10008.1.2.1
CT Image Storage	1.2.840.10008.5.1.4.1.1.2	JPEG Lossless, Non-Hierarchical, First-Order Prediction (Process 14 [Selection Value 1])*	1.2.840.10008.1.2.4.70
Secondary Capture Image Storage (Grayscale)	1.2.840.10008.5.1.4.1.1.7	Explicit VR Little Endian Uncompressed	1.2.840.10008.1.2.1
Secondary Capture Image Storage (Grayscale)	1.2.840.10008.5.1.4.1.1.7	JPEG Lossless, Non-Hierarchical, First-Order Prediction (Process 14 [Selection Value 1])*	1.2.840.10008.1.2.4.70
Secondary Capture Image Storage (Color, RGB)	1.2.840.10008.5.1.4.1.1.7	Explicit VR Little Endian Uncompressed	1.2.840.10008.1.2.1
Secondary Capture Image Storage (Color, RGB)	1.2.840.10008.5.1.4.1.1.7	JPEG Lossless, Non-Hierarchical, First-Order Prediction (Process 14 [Selection Value 1])*	1.2.840.10008.1.2.4.70
Standalone Curve Storage	1.2.840.10008.5.1.4.1.1.9	Explicit VR Little Endian Uncompressed	1.2.840.10008.1.2.1
Enhanced CT Image Storage	1.2.840.10008.5.1.4.1.1.2.1	Explicit VR Little Endian Uncompressed	1.2.840.10008.1.2.1
Grayscale Softcopy Presentation State Storage	1.2.840.10008.5.1.4.1.1.11.1	Explicit VR Little Endian Uncompressed	1.2.840.10008.1.2.1
Enhanced SR Storage	1.2.840.10008.5.1.4.1.1.88.22	Explicit VR Little Endian Uncompressed	1.2.840.10008.1.2.1
X-Ray Radiation Dose SR Storage	1.2.840.10008.5.1.4.1.1.88.67	Explicit VR Little Endian Uncompressed	1.2.840.10008.1.2.1
TOSHIBA CT Non-Image Storage	1.2.392.200036.9116.2.6.1.1	Explicit VR Little Endian Uncompressed	1.2.840.10008.1.2.1

*: The JPEG Transfer Syntax is not supported for the DED-CT-DVD-RAM.

5.3 AUGMENTED AND PRIVATE APPLICATION PROFILES

5.3.1 Augmented Application Profiles

Not applicable to this product

5.3.2 Private Application Profiles

5.3.2.1 Private Application Profiles – DED-CT-CD-R and DED-CT-DVD

5.3.2.1.1 SOP Class Privatizations

The Private Application Profile supports following SOP Class UID and Transfer Syntax.

Table 5.3-1
SOP Class Privatizations

Information Object Definition	SOP Class UID	Transfer Syntax	Transfer Syntax UID
Toshiba CT Non-Image Storage	1.2.392.200036.9116.2.6.1.1	Explicit VR Little Endian Uncompressed	1.2.840.10008.1.2.1

5.3.2.1.2 Directory Privatizations

Additional key attributes for this profile are listed in the table below.

Table 5.3-2
Additional key attributes for DED-CT-CD-R and DED-CT-DVD Application Profile

Key Attribute	Tag	Directory Record Type	Notes
Organ	(7005,xx0d)	STUDY	Typical organ in the Study
Main Modality in Study	(7005,xx30)	STUDY	Main Modality in the Study
Filter	(7005,xx0b)	SERIES	Typical Image Filter in the Series.
Patient Direction	(7005,xx0f)	SERIES	Patient Direction, "HF", "FF", etc.
Series Comment	(7005,xx11)	SERIES	Series Comment
Patient Position	(7005,xx12)	SERIES	Patient Position, "SU", "PR", etc.
Expert Plan No.	(7005,xx13)	SERIES	Expert Plan (Examination Plan) No.
Reconstruction ROI No.	(7005,xx14)	SERIES	Reconstruction ROI No.
Special Helical ACQ No.	(7005,xx15)	SERIES	Special Helical Acquisition No.
Convolution Kernel	(7005,xx1b)	SERIES	Typical Convolution Kernel in the Series
Contrast/Bolus Agent	(7005,xx1c)	SERIES	Typical Contrast/Bolus Agent in the Series.
Filter	(7005,xx0b)	IMAGE	Image Filter
File Type Remarks	(7005,xx0e)	IMAGE, CURVE, PRIVATE	File Type Remarks

5.3.2.1.3 Other Privatizations

Not applicable to this product

5.3.2.2 Private Application Profiles – DED-CT-DVD-RAM

5.3.2.2.1 SOP Class Privatizations

The Private Application Profile supports following SOP Class UID and Transfer Syntax.

Table 5.3-3
SOP Class Privatizations

Information Object Definition	SOP Class UID	Transfer Syntax	Transfer Syntax UID
Toshiba CT Non-Image Storage	1.2.392.200036.9116.2.6.1.1	Explicit VR Little Endian Uncompressed	1.2.840.10008.1.2.1

5.3.2.2.2 Directory Privatizations

Additional key attributes for this profile are listed in the table below.

Table 5.3-4
Additional key attributes for DED-CT-DVD-RAM Application Profile

Key Attribute	Tag	Directory Record Type	Notes
Organ	(7005,xx0d)	STUDY	Typical organ in the Study
Main Modality in Study	(7005,xx30)	STUDY	Main Modality in the Study
Protect Mark for Study Record	(7005,xxf3)	STUDY	Study Protection Mark, "P" or " ".
Filter	(7005,xx0b)	SERIES	Typical Image Filter in the Series.
Patient Direction	(7005,xx0f)	SERIES	Patient Direction, "HF", "FF", etc.
Series Comment	(7005,xx11)	SERIES	Series Comment
Patient Position	(7005,xx12)	SERIES	Patient Position, "SU", "PR", etc.
Expert Plan No.	(7005,xx13)	SERIES	Expert Plan (Examination Plan) No.
Reconstruction ROI No.	(7005,xx14)	SERIES	Reconstruction ROI No.
Special Helical ACQ No.	(7005,xx15)	SERIES	Special Helical Acquisition No.
Convolution Kernel	(7005,xx1b)	SERIES	Typical Convolution Kernel in the Series
Contrast/Bolus Agent	(7005,xx1c)	SERIES	Typical Contrast/Bolus Agent in the Series.
Protect Mark for Series Record	(7005,xxf2)	SERIES	Series Protection Mark, "P" or " ".
Filter	(7005,xx0b)	IMAGE	Image Filter
File Type Remarks	(7005,xx0e)	IMAGE, CURVE, PRIVATE	File Type Remarks
Protect Mark for Image, Curve or Private Record	(7005,xxf1)	IMAGE, CURVE, PRIVATE	Instance Protection Mark, "P" or " ".

5.3.2.2.3 Other Privatizations

Not applicable to this product

5.4 MEDIA CONFIGURATION

Not applicable to the Offline-Media AE.

7. SECURITY

This product does not support any specific security measures.

It is assumed that the product is used within a secured environment. It is assumed that a secured environment includes at a minimum:

- a. Firewall or router protections to ensure that only approved external hosts have network access to the product.
- b. Firewall or router protections to ensure that the product only has network access to approved external hosts and services.
- c. Any communication with external hosts and services outside the locally secured environment use appropriate secure network channels (e.g. such as a Virtual Private Network (VPN))

Other network security procedures such as automated intrusion detection may be appropriate in some environments. Additional security features may be established by the local security policy and are beyond the scope of this conformance statement.

8. ANNEXES

8.1 IOD CONTENTS

8.1.1 Created SOP Instances

Table 8.1-1 specifies the attributes of a CT Image transmitted by the Storage SCU AE.

Table 8.1-2 specifies the attributes of a Secondary Capture Image transmitted by the Storage SCU AE.

Table 8.1-3 specifies the attributes of a Standalone Curve transmitted by the Storage SCU AE.

Table 8.1-4 specifies the attributes of an Enhanced CT Image transmitted by the Storage SCU AE.

The following tables use a number of abbreviations. The abbreviations used in the “Presence of ...” column are:

VNAP	Value Not Always Present (attribute sent zero length if no value is present)
ANAP	Attribute Not Always Present
ALWAYS	Always Present
EMPTY	Attribute is sent without a value

The abbreviations used in the “Source” column:

MWL	the attribute value source is from Modality Worklist
USER	the attribute value source is from User input
AUTO	the attribute value is generated automatically
MPPS	the attribute value is the same as that use for Modality Performed Procedure Step
CONFIG	the attribute value source is a configurable parameter

8.1.1.1 CT Image IOD

**Table 8.1-1
IOD OF CREATED CT IMAGE SOP INSTANCES**

IE	Module	Reference	Presence of Module
Patient	Patient	Table 8.1-11	ALWAYS
Study	General Study	Table 8.1-12	ALWAYS
	Patient Study	Table 8.1-13	Only if "Patient's Age" is present
Series	General Series	Table 8.1-14	ALWAYS
Frame of Reference	Frame of Reference	Table 8.1-15	ALWAYS
Equipment	General Equipment	Table 8.1-16	ALWAYS
Image	General Image	Table 8.1-17	ALWAYS
	Image Plane	Table 8.1-18	ALWAYS
	Image Pixel	Table 8.1-19	ALWAYS
	Contrast/Bolus	Table 8.1-20	Only if contrast media was used in this image
	VOI LUT	Table 8.1-21	ALWAYS
	SOP Common	Table 8.1-22	ALWAYS
	CT Image	Table 8.1-23	ALWAYS
	Private Application	Table 8.1-24	Only if private data are present

8.1.1.2 SC Image IOD

**Table 8.1-2
IOD OF CREATED SC IMAGE SOP INSTANCES**

IE	Module	Reference	Presence of Module
Patient	Patient	Table 8.1-11	ALWAYS
Study	General Study	Table 8.1-12	ALWAYS
	Patient Study	Table 8.1-13	Only if "Patient's Age" is present
Series	General Series	Table 8.1-14	ALWAYS
Equipment	General Equipment	Table 8.1-16	ALWAYS
	SC Equipment	Table 8.1-25	ALWAYS
Image	General Image	Table 8.1-17	ALWAYS
	Image Pixel	Table 8.1-26	ALWAYS
	SC Image	Table 8.1-27	ALWAYS
	VOI LUT	Table 8.1-28	ALWAYS
	SOP Common	Table 8.1-29	ALWAYS
	Private Application	Table 8.1-30	Only if private data are present

8.1.1.3 Standalone Curve IOD

**Table 8.1-3
IOD OF CREATED STANDALONE CURVE SOP INSTANCES**

IE	Module	Reference	Presence of Module
Patient	Patient	Table 8.1-11	ALWAYS
Study	General Study	Table 8.1-12	ALWAYS
	Patient Study	Table 8.1-13	Only if "Patient's Age" is present
Series	General Series	Table 8.1-14	ALWAYS
Equipment	General Equipment	Table 8.1-16	ALWAYS
Curve	Curve Identification	Table 8.1-31	ALWAYS
	Curve	Table 8.1-32	ALWAYS
	SOP Common	Table 8.1-33	ALWAYS
	Private Application	Table 8.1-34	Only if private data are present

8.1.1.4 Enhanced CT Image IOD

**Table 8.1-4
IOD OF CREATED ENHANCED CT IMAGE SOP INSTANCES**

IE	Module	Reference	Presence of Module
Patient	Patient	Table 8.1-11	ALWAYS
Study	General Study	Table 8.1-12	ALWAYS
	Patient Study	Table 8.1-13	Only if "Patient's Age" is present
Series	General Series	Table 8.1-14	ALWAYS
	CT Series	Table 8.1-35	ALWAYS
Frame of Reference	Frame of Reference	Table 8.1-15	ALWAYS
Equipment	General Equipment	Table 8.1-16	ALWAYS
Image	Image Pixel	Table 8.1-36	ALWAYS
	Enhanced Contrast/Bolus	Table 8.1-37	Only if contrast media was applied
	Multi-frame Functional Groups	Table 8.1-38	ALWAYS
	Multi-frame Dimension	Table 8.1-39	ALWAYS
	Cardiac Synchronization	Table 8.1-40	Only if cardiac synchronization was applied
	Respiratory Synchronization	Table 8.1-41	Only if respiratory synchronization was applied
	Acquisition Context	Table 8.1-42	ALWAYS
	Enhanced CT Image	Table 8.1-43	ALWAYS
	Softcopy Presentation LUT	Table 8.1-44	ALWAYS
	SOP Common	Table 8.1-45	ALWAYS
	Private Application	Table 8.1-46	Only if private data are present

**Table 8.1-5
FUNCTIONAL GROUP MACROS OF CREATED ENHANCED CT IMAGE SOP INSTANCES**

Functional Group Macro	Reference	Presence of Macro
Pixel Measures	Table 8.1-47	ALWAYS
Frame Content	Table 8.1-48	ALWAYS
Plane Position	Table 8.1-49	ALWAYS
Plane Orientation	Table 8.1-50	ALWAYS
Referenced Image	Table 8.1-51	Only if the image or frame has been planned on another image or frame
Derivation Image	Table 8.1-52	Only if the image or frame has been derived from another SOP Instance
Cardiac Trigger	Table 8.1-53	Only if cardiac synchronization was applied
Respiratory Trigger	Table 8.1-54	Only if respiratory synchronization was applied
Frame Anatomy	Table 8.1-55	ALWAYS
Frame VOI LUT	Table 8.1-56	ALWAYS
Contrast/Bolus Usage	Table 8.1-57	Only if contrast media was applied
CT Image Frame Type	Table 8.1-58	ALWAYS
CT Acquisition Type	Table 8.1-59	Only if Image Type (0008,0008) Value 1 is ORIGINAL
CT Acquisition Details	Table 8.1-60	Only if Image Type (0008,0008) Value 1 is ORIGINAL
CT Table Dynamics	Table 8.1-61	Only if Image Type (0008,0008) Value 1 is ORIGINAL
CT Position	Table 8.1-62	Only if Image Type (0008,0008) Value 1 is ORIGINAL
CT Geometry	Table 8.1-63	Only if Image Type (0008,0008) Value 1 is ORIGINAL
CT Reconstruction	Table 8.1-64	Only if Image Type (0008,0008) Value 1 is ORIGINAL and Acquisition Type (0018,9302) is other than COSTANT_ANGLE
CT Exposure	Table 8.1-65	Only if Image Type (0008,0008) Value 1 is ORIGINAL
CT X-ray Details	Table 8.1-66	Only if Image Type (0008,0008) Value 1 is ORIGINAL
CT Pixel Value Transformation	Table 8.1-67	ALWAYS
Enhanced CT Private	Table 8.1-72	ANAP

8.1.1.5 Grayscale Softcopy Presentation State IOD

**Table 8.1-6
IOD OF CREATED GRAYSCALE SOFTCOPY PRESENTATION STATE SOP INSTANCES**

IE	Module	Reference	Presence of Module
Patient	Patient	Table 8.1-11	ALWAYS
Study	General Study	Table 8.1-12	ALWAYS
	Patient Study	Table 8.1-13	Only if "Patient's Age" is present
Series	General Series	Table 8.1-14	ALWAYS
	Presentation Series	Table 8.1-73	ALWAYS
Equipment	General Equipment	Table 8.1-16	ALWAYS
Presentation State	Presentation State	Table 8.1-74	ALWAYS
	Displayed Area	Table 8.1-75	ALWAYS
	Spatial Transformation	Table 8.1-76	Only if Graphic Annotations are to be applied to referenced image(s)
	Modality LUT	Table 8.1-77	ALWAYS
	Softcopy VOI LUT	Table 8.1-78	Only if a VOI LUT is to be applied to referenced image(s)
	Softcopy Presentation LUT	Table 8.1-79	ALWAYS
	SOP Common	Table 8.1-80	ALWAYS
	Private Application	Table 8.1-81	Only if private data are present

8.1.1.6 Enhanced SR IOD

**Table 8.1-7
IOD OF CREATED ENHANCED SR SOP INSTANCES**

IE	Module	Reference	Presence of Module
Patient	Patient	Table 8.1-11	ALWAYS
Study	General Study	Table 8.1-12	ALWAYS
	Patient Study	Table 8.1-13	Only if "Patient's Age" is present
Series	SR Series	Table 8.1-82	ALWAYS
Equipment	General Equipment	Table 8.1-16	ALWAYS
Document	SR Document General	Table 8.1-83	ALWAYS
	SR Document Content	Table 8.1-105	ALWAYS
	SOP Common	Table 8.1-84	ALWAYS

8.1.1.7 X-Ray Radiation Dose SR IOD

**Table 8.1-8
IOD OF CREATED X-RAY RADIATION DOSE SR SOP INSTANCES**

IE	Module	Reference	Presence of Module
Patient	Patient	Table 8.1-11	ALWAYS
Study	General Study	Table 8.1-12	ALWAYS
	Patient Study	Table 8.1-13	Only if "Patient's Age" is present
Series	SR Series	Table 8.1-82	ALWAYS
Equipment	General Equipment	Table 8.1-16	ALWAYS
Document	SR Document General	Table 8.1-83	ALWAYS
	SR Document Content	Table 8.1-113	ALWAYS
	SOP Common	Table 8.1-84	ALWAYS

8.1.1.8 Segmentation IOD

**Table 8.1-9
IOD OF CREATED SEGMENTATION SOP INSTANCES**

IE	Module	Reference	Presence of Module
Patient	Patient	Table 8.1-11	ALWAYS
Study	General Study	Table 8.1-12	ALWAYS
	Patient Study	Table 8.1-13	Only if "Patient's Age" is present
Series	General Series	Table 8.1-14	ALWAYS
	Segmentation Series	Table 8.1-88	ALWAYS
Frame of Reference	Frame of Reference	Table 8.1-15	ALWAYS
Equipment	General Equipment	Table 8.1-16	ALWAYS
	Enhanced General Equipment	Table 8.1-89	ALWAYS
Segmentation	General Image	Table 8.1-17	ALWAYS
	Image Pixel	Table 8.1-90	ALWAYS
	Segmentation Image	Table 8.1-91	ALWAYS
	Multi-frame Functional Groups	Table 8.1-92	ALWAYS
	Multi-frame Dimension	Table 8.1-93	ALWAYS
	SOP Common	Table 8.1-94	ALWAYS
	Private Application	Table 8.1-95	Only if private data are present

**Table 8.1-10
FUNCTIONAL GROUP MACROS OF CREATED SEGMENTATION SOP INSTANCES**

Functional Group Macro	Reference	Presence of Macro
Pixel Measures	Table 8.1-99	ALWAYS
Frame Content	Table 8.1-100	ALWAYS
Plane Position	Table 8.1-101	ALWAYS
Plane Orientation	Table 8.1-102	ALWAYS
Segmentation	Table 8.1-103	ALWAYS

8.1.1.9 Common Modules

**Table 8.1-11
PATIENT MODULE OF CREATED SOP INSTANCES**

Attribute Name	Tag	VR	Value	Presence of Value	Source
Patient's Name	(0010,0010)	PN	From Modality Worklist or user input. Values supplied via Modality Worklist will be entered as received. Maximum 64 characters.	VNAP	MWL/ USER
Patient ID	(0010,0020)	LO	From Modality Worklist or user input. Maximum 64 characters.	VNAP	MWL/ USER
Patient's Birth Date	(0010,0030)	DA	From Modality Worklist or user input	VNAP	MWL/ USER
Patient's Sex	(0010,0040)	CS	From Modality Worklist or user input	VNAP	MWL/ USER
Patient Comments	(0010,4000)	LT	From User Input. Maximum 1024 characters.	VNAP	USER

**Table 8.1-12
GENERAL STUDY MODULE OF CREATED SOP INSTANCES**

Attribute Name	Tag	VR	Value	Presence of Value	Source
Study Instance UID	(0020,000D)	UI	From Modality Worklist or generated by device	ALWAYS	MWL/AUTO
Study Date	(0008,0020)	DA	<yyyymmdd>	ALWAYS	AUTO
Study Time	(0008,0030)	TM	<hhmmss.frac>	ALWAYS	AUTO
Referring Physician's Name	(0008,0090)	PN	From Modality Worklist	VNAP	MWL
Study ID	(0020,0010)	SH	Requested Procedure ID from Worklist or User Input	VNAP	MWL/USER
Accession Number	(0008,0050)	SH	From Modality Worklist or user input	VNAP	MWL/USER
Referenced Study Sequence	(0008,1110)	SQ	From Modality Worklist	ANAP	MWL
>Referenced SOP Class UID	(0008,1150)	UI	From Modality Worklist	ANAP	MWL
>Referenced SOP Instance UID	(0008,1155)	UI	From Modality Worklist	ANAP	MWL
Procedure Code Sequence	(0008,1032)	SQ	From Modality Worklist	ANAP	MWL

**Table 8.1-13
PATIENT STUDY MODULE OF CREATED SOP INSTANCES**

Attribute Name	Tag	VR	Value	Presence of Value	Source
Patient's Age	(0010,1010)	AS	Calculated from DoB input on base of actual Date	ALWAYS	AUTO

**Table 8.1-14
GENERAL SERIES MODULE OF CREATED SOP INSTANCES**

Attribute Name	Tag	VR	Value	Presence of Value	Source
Modality	(0008,0060)	CS	"CT"	ALWAYS	AUTO
Series Instance UID	(0020,000E)	UI	Generated by device	ALWAYS	AUTO
Series Number	(0020,0011)	IS	Generated by device	ALWAYS	AUTO
Series Date	(0008,0021)	DA		ANAP	AUTO
Series Time	(0008,0031)	TM		ANAP	AUTO
Operator's Name	(0008,1070)	PN	Operator field in Study list. Maximum 64 characters.	VNAP	USER
Protocol Name	(0018,1030)	LO		ANAP	AUTO
Body Part Examined	(0018,0015)	CS		ANAP	USER
Patient Position	(0018,5100)	CS		ALWAYS	AUTO
Laterality	(0020,0060)	CS		VNAP	AUTO
Request Attributes Sequence	(0040,0275)	SQ	From Modality Worklist	ANAP	MWL
>Requested Procedure ID	(0040,1001)	SH	From Modality Worklist	ANAP	MWL
>Scheduled Procedure Step ID	(0040,0009)	SH	From Modality Worklist	ANAP	MWL
>Scheduled Procedure Step Description	(0040,0007)	LO	From Modality Worklist	ANAP	MWL
Performed Procedure Step ID	(0040,0253)	SH	Generated by device	ANAP	AUTO
Performed Procedure Step Description	(0040,0254)	LO	From Modality Worklist Study Description(0008,1030)	ANAP	MWL

**Table 8.1-15
FRAME OF REFERENCE MODULE OF CREATED SOP INSTANCES**

Attribute Name	Tag	VR	Value	Presence of Value	Source
Frame of Reference UID	(0020,0052)	UI		ALWAYS	AUTO
Position Reference Indicator	(0020,1040)	LO		VNAP	AUTO

**Table 8.1-16
GENERAL EQUIPMENT MODULE OF CREATED SOP INSTANCES**

Attribute Name	Tag	VR	Value	Presence of Value	Source
Manufacturer	(0008,0070)	LO	"TOSHIBA"	ALWAYS	AUTO
Institution Name	(0008,0080)	LO	From Configuration	ALWAYS	CONFIG
Station Name	(0008,1010)	SH	From Configuration	ALWAYS	CONFIG
Institution Department Name	(0008,1040)	LO	From Configuration	VNAP	CONFIG
Manufacturer's Model Name	(0008,1090)	LO	Aquilion or Asteion or Alexion Activion	ALWAYS	AUTO
Device Serial Number	(0018,1000)	LO	From Configuration	VNAP	CONFIG
Software Version	(0018,1020)	LO	From Configuration	VNAP	CONFIG

**Table 8.1-17
GENERAL IMAGE MODULE OF CREATED SOP INSTANCES**

Attribute Name	Tag	VR	Value	Presence of Value	Source
Instance Number	(0020,0013)	IS	Generated by device	ALWAYS	AUTO
Patient Orientation	(0020,0020)	CS		VNAP	AUTO
Content Date	(0008,0023)	DA	<yyyymmdd>	ALWAYS	AUTO
Content Time	(0008,0033)	TM	<hhmmss.frac>	ALWAYS	AUTO
Image Type	(0008,0008)	CS		ALWAYS	AUTO
Acquisition Number	(0020,0012)	IS	Generated by device	ALWAYS	AUTO
Acquisition Date	(0008,0022)	DA	<yyyymmdd>	ALWAYS	AUTO
Acquisition Time	(0008,0032)	TM	<hhmmss.frac>	ALWAYS	AUTO
Image in Acquisition	(0020,1002)	IS		VNAP	AUTO
Image Comments	(0020,4000)	LT	From user input. Maximum 44 characters.	VNAP	USER

8.1.1.10 CT Image Modules

**Table 8.1-18
IMAGE PLANE MODULE OF CREATED CT IMAGE SOP INSTANCES**

Attribute Name	Tag	VR	Value	Presence of Value	Source
Pixel Spacing	(0028,0030)	DS		ALWAYS	AUTO
Image Position (Patient)	(0020,0032)	DS		ALWAYS	AUTO
Image Orientation (Patient)	(0020,0037)	DS		ALWAYS	AUTO
Slice Thickness	(0018,0050)	DS		ALWAYS	AUTO
Slice Location	(0020,1041)	DS		ANAP	AUTO

**Table 8.1-19
IMAGE PIXEL MODULE OF CREATED CT IMAGE SOP INSTANCES**

Attribute Name	Tag	VR	Value	Presence of Value	Source
Pixel Representation	(0028,0103)	US	1	ALWAYS	AUTO
Rows	(0028,0010)	US		ALWAYS	AUTO
Columns	(0028,0011)	US		ALWAYS	AUTO
Pixel Data	(7FE0,0010)	OB or OW		ALWAYS	AUTO

**Table 8.1-20
CONTRAST/BOLUS MODULE OF CREATED CT IMAGE SOP INSTANCES**

Attribute Name	Tag	VR	Value	Presence of Value	Source
Contrast/Bolus Agent	(0018,0010)	LO		VNAP	USER
Contrast/Bolus Route	(0018,1040)	LO		ANAP	USER
Contrast/Bolus Volume	(0018,1041)	DS		ANAP	AUTO
Contrast/Bolus Start Time	(0018,1042)	TM		ANAP	AUTO
Contrast/Bolus Stop Time	(0018,1043)	TM		ANAP	AUTO
Contrast/Bolus Total Dose	(0018,1044)	DS		ANAP	AUTO

**Table 8.1-21
VOI/LUT MODULE OF CREATED CT IMAGE SOP INSTANCES**

Attribute Name	Tag	VR	Value	Presence of Value	Source
Window Center	(0028,1050)	DS		ALWAYS	USER or AUTO
Window Width	(0028,1051)	DS		ALWAYS	USER or AUTO

Table 8.1-22
SOP COMMON MODULE OF CREATED CT IMAGE SOP INSTANCES

Attribute Name	Tag	VR	Value	Presence of Value	Source
Specific Character set	(0008,0005)	CS	Refer to Section 6	ANAP	CONFIG
SOP Class UID	(0008,0016)	UI	"1.2.840.10008.5.1.4.1.1.2"	ALWAYS	AUTO
SOP Instance UID	(0008,0018)	UI	Generated by device	ALWAYS	AUTO

Table 8.1-23
CT IMAGE MODULE OF CREATED CT IMAGE SOP INSTANCES

Attribute Name	Tag	VR	Value	Presence of Value	Source
Image Type	(0008,0008)	CS	“ORIGINAL¥PRIMARY¥LOCALIZER” “ORIGINAL¥PRIMARY¥AXIAL” “DERIVED¥SECONDARY” “DERIVED¥ PRIMARY¥AXIAL” “DERIVED¥SECONDERY¥AXIAL” “DERIVED¥SECONDERY¥AXIAL ¥REGISTRATION” “DERIVED¥SECONDERY¥AXIAL ¥SUBTRACTION”	ALWAYS	AUTO
Samples per Pixel	(0028,0002)	US	1	ALWAYS	AUTO
Photometric Interpretation	(0028,0004)	CS	“MONOCHROME2”	ALWAYS	AUTO
Bits Allocated	(0028,0100)	US	16	ALWAYS	AUTO
Bits Stored	(0028,0101)	US	16	ALWAYS	AUTO
High Bit	(0028,0102)	US	15	ALWAYS	AUTO
Rescale Intercept	(0028,1052)	DS	“0”	ALWAYS	AUTO
Rescale Slope	(0028,1053)	DS	“1”	ALWAYS	AUTO
Rescale Type	(0028,1054)	LO	“US”	ANAP	AUTO
KVP	(0018,0060)	DS		VNAP	AUTO
Acquisition Number	(0020,0012)	IS		VNAP	AUTO
Scan Options	(0018,0022)	CS		ANAP	AUTO
Data Collection Diameter	(0018,0090)	DS		ANAP	AUTO
Reconstruction Diameter	(0018,1100)	DS		ANAP	AUTO
Distance Source to Detector	(0018,1110)	DS		ANAP	AUTO
Distance Source to Patient	(0018,1111)	DS		ANAP	AUTO
Gantry/Detector Tilt	(0018,1120)	DS		ANAP	AUTO
Table Height	(0018,1130)	DS		ANAP	AUTO
Rotation Direction	(0018,1140)	CS		ANAP	AUTO
Exposure Time	(0018,1150)	IS		ANAP	AUTO
Exposure	(0018,1152)	IS		ANAP	AUTO
Filter Type	(0018,1160)	SH		ANAP	AUTO
Generator Power	(0018,1170)	IS		ANAP	AUTO
Focal Spot(s)	(0018,1190)	DS		ANAP	AUTO
Convolution Kernel	(0018,1210)	SH		ANAP	AUTO
Revolution Time	(0018,9305)	FD		ANAP	AUTO
Single Collimation Width	(0018,9306)	FD		ANAP	AUTO
Total Collimation Width	(0018,9307)	FD		ANAP	AUTO
Table Feed per Rotation	(0018,9310)	FD		ANAP	AUTO

Spiral Pitch Factor	(0018,9311)	FD		ANAP	AUTO
Reconstruction Target Center (Patient)	(0018,9318)	FD		ANAP	AUTO
Exposure Modulation Type	(0018,9323)	CS	"NONE"	ANAP	AUTO
Estimated Dose Saving	(0018,9324)	FD		ANAP	AUTO
CTDIvol	(0018,9345)	FD		ANAP	AUTO
Filter Material	(0018,7050)	CS	"COPPER"	ANAP	AUTO
Acquisition Type	(0018,9302)	CS		ANAP	AUTO
Tube Angle	(0018,9303)	FD		ANAP	AUTO
Table Position	(0018,9327)	FD		ANAP	AUTO
Fluoroscopy Flag	(0018,9334)	CS		ANAP	AUTO
Respiratory Interval Time	(0020,9254)	FD		ANAP	AUTO

**Table 8.1-24
PRIVATE APPLICATION MODULE OF CREATED CT IMAGE SOP INSTANCES**

Attribute Name	Tag	VR	Value	Presence of Value	Source
Private Creator Code	(7005,00xx)	LO	"TOSHIBA_MEC_CT3"	ANAP	AUTO
CT Private Data 1	(7005,xx00)	OB		ANAP	AUTO
Cardiac R-R Mean Time	(7005,xx03)	SH	Ex.) "9999.9ms"	ANAP	AUTO
Cardiac Reconstruction Getting Phase in Percent	(7005,xx04)	SH	Ex.) "99%"	ANAP	AUTO
Cardiac Reconstruction Getting Phase in ms	(7005,xx05)	SH	Ex.) "999ms"	ANAP	AUTO
Cardiac Reconstruction Mode	(7005,xx06)	SH	"HALF", "SEGMENT"	ANAP	AUTO
Reconstruction Center	(7005,xx07)	DS		ANAP	AUTO
Detector Slice Thickness in mm	(7005,xx08)	DS	Ex.) "+9999.99"	ANAP	AUTO
Number of Detector rows to Reconstruct	(7005,xx09)	LO	Ex.) "0000111111110000" or "FFFF" 8 detectors were used to reconstruct image	ANAP	AUTO
Table Speed in mm/rot	(7005,xx0A)	DS	Ex.) "+99.99"	ANAP	AUTO
Filter	(7005,xx0B)	SH	Ex.) "ORG "	ANAP	AUTO
Reconstruction Correction Type	(7005,xx0C)	SH		ANAP	AUTO
Organ	(7005,xx0D)	CS	Typical organ in the Study.	ANAP	AUTO
File Type Remarks	(7005,xx0E)	SH	"IMG"	ANAP	AUTO
Direction	(7005,xx0F)	SH	"HF", "FF", etc.	ANAP	AUTO
CT Private Data 2	(7005,xx10)	OB		ANAP	AUTO
Series Comment	(7005,xx11)	LT		ANAP	AUTO
Position	(7005,xx12)	SH	"SU", "PR", etc.	ANAP	AUTO
Expert Plan No.	(7005,xx13)	US		ANAP	AUTO
Reconstruction ROI No.	(7005,xx14)	US		ANAP	AUTO
Special Helical ACQ No.	(7005,xx15)	US		ANAP	AUTO
Volume UID	(7005,xx16)	UI		ANAP	AUTO
Total Frame Count in the Volume	(7005,xx17)	US		ANAP	AUTO
Frame No.	(7005,xx18)	US		ANAP	AUTO
Frame Sort Key	(7005,xx19)	UL		ANAP	AUTO
Frame Sort Order	(7005,xx1A)	US		ANAP	AUTO
Convolution Kernel for Series Record	(7005,xx1B)	SH	Ex.) "FL99" or "FC99"	ANAP	AUTO
Contrast/Bolus Agent for Series Record	(7005,xx1C)	LO		ANAP	AUTO
Reconstruction Number	(7005,xx1D)	UL		ANAP	AUTO
Raw Data Number	(7005,xx1E)	UL		ANAP	AUTO
Volume Number	(7005,xx1F)	LO		ANAP	AUTO

Local Series Number	(7005,xx20)	UL		ANAP	AUTO
Decrease in Artifact Filter	(7005,xx21)	LO	Ex.) "RASP", "BOOST"	ANAP	AUTO
Reconstruction Interval	(7005,xx22)	DS	Ex.) "7.00"	ANAP	AUTO
Pitch Factor	(7005,xx23)	DS	Ex.) "0.641"	ANAP	AUTO
The Acquisition Date of NRA	(7005,xx24)	DA	Ex.) "20051121"	ANAP	AUTO
Main Modality in Study	(7005,xx30)	CS	Ex.) "CT"	ANAP	AUTO
DLP (Dose Length Product)	(7005,xx40)	FD		ANAP	AUTO
Row Slice Information	(7005,xx41)	SH	Ex.) "0.5x64", "10.0x2", "1.0x1"	ANAP	AUTO
Volume Vector	(7005,xx43)	DS		ANAP	AUTO
Volume Type	(7005,xx44)	US		ANAP	AUTO
Relative Table Position of 4D Volume	(7005,xx45)	DS		ANAP	AUTO
Absolute Table Position of 4D Volume	(7005,xx46)	DS		ANAP	AUTO
Slice Pitch of 4D Volume	(7005,xx47)	DS		ANAP	AUTO
Respiratory Gating Inf.	(7005,xx48)	LO	Ex.) "RG Ph 50%/5000 ms"	ANAP	AUTO
Respiratory Phase	(7005,xx49)	SH	Ex.) "75%"	ANAP	AUTO
CTDIw	(7005,xx63)	FD		ANAP	AUTO
Volume UID of 4D-Volume	(7005,xx67)	UI		ANAP	AUTO
Total Frame Count in 4D-Volume	(7005,xx68)	US		ANAP	AUTO
Frame Number in 4D-Volume	(7005,xx69)	US		ANAP	AUTO
Image Position of 4D-Volume Top	(7005,xx6a)	DS		ANAP	AUTO
Image Position of 4D-Volume Top (Equipment)	(7005,xx6b)	DS		ANAP	AUTO
SOP Instance UID of 4D-Volume	(7005,xx6c)	UI		ANAP	AUTO
Series Instance UID of 4D-Volume	(7005,xx6d)	UI		ANAP	AUTO
Stitching	(7005,xx6e)	SH		ANAP	AUTO
Injector Elapsed Time	(7005,xx79)	SH		ANAP	AUTO
Series Instance UID of Shuttle Helical Volume	(7005,xx7a)	UI		ANAP	AUTO
Basis Material of Raw Data DE	(7005,xx7b)	LO		ANAP	AUTO

NOTE: CT Private Data 1 (7005,xx00) or CT Private Data 2 (7005,xx10) may contain some patient information.

8.1.1.11 SC Image Modules

**Table 8.1-25
SC EQUIPMENT MODULE OF CREATED SC IMAGE SOP INSTANCES**

Attribute Name	Tag	VR	Value	Presence of Value	Source
Conversion Type	(0028,0064)	CS	"WSD"	ALWAYS	AUTO
Modality	(0008,0060)	CS	"CT"	ALWAYS	AUTO
Secondary Capture Device ID	(0018,1010)	LO		ANAP	AUTO
Secondary Capture Device Manufacture	(0018,1016)	LO		ANAP	AUTO
Secondary Capture Manufacturer's Model Name	(0018,1018)	LO		ANAP	AUTO
Secondary Capture Device Software Version	(0018,1019)	LO		ANAP	AUTO

**Table 8.1-26
IMAGE PIXEL MODULE OF CREATED SC IMAGE SOP INSTANCES**

Attribute Name	Tag	VR	Value	Presence of Value	Source
Samples per Pixel	(0028,0002)	US	1 or 3	ALWAYS	AUTO
Photometric Interpretation	(0028,0004)	CS	"MONOCHROME2" or "RGB"	ALWAYS	AUTO
Rows	(0028,0010)	US		ALWAYS	AUTO
Columns	(0028,0011)	US		ALWAYS	AUTO
Bits Allocated	(0028,0100)	US	16 or 8	ALWAYS	AUTO
Bits Stored	(0028,0101)	US	16 or 8	ALWAYS	AUTO
High Bit	(0028,0102)	US	15 or 7	ALWAYS	AUTO
Pixel Representation	(0028,0103)	US	0	ALWAYS	AUTO
Pixel Data	(7FE0,0010)	OB or OW		ALWAYS	AUTO
Planar Configuration	(0028,0006)	US	0	ANAP	AUTO

**Table 8.1-27
SC IMAGE MODULE OF CREATED SC IMAGE SOP INSTANCES**

Attribute Name	Tag	VR	Value	Presence of Value	Source
Date of Secondary Capture	(0018,1012)	DA		ANAP	AUTO
Date of Secondary Capture	(0018,1014)	TM		ANAP	AUTO

**Table 8.1-28
VOI/LUT MODULE OF CREATED SC IMAGE SOP INSTANCES**

Attribute Name	Tag	VR	Value	Presence of Value	Source
Window Center	(0028,1050)	DS		ANAP	USER or AUTO
Window Width	(0028,1051)	DS		ANAP	USER or AUTO

**Table 8.1-29
SOP COMMON MODULE OF CREATED SC IMAGE SOP INSTANCES**

Attribute Name	Tag	VR	Value	Presence of Value	Source
Specific Character set	(0008,0005)	CS	Refer to Section 6	ANAP	CONFIG
SOP Class UID	(0008,0016)	UI	"1.2.840.10008.5.1.4.1.1.7"	ALWAYS	AUTO
SOP Instance UID	(0008,0018)	UI	Generated by device	ALWAYS	AUTO

**Table 8.1-30
PRIVATE APPLICATION MODULE OF CREATED SC IMAGE SOP INSTANCES**

Attribute Name	Tag	VR	Value	Presence of Value	Source
Private Creator Code	(7005,00xx)	LO	"TOSHIBA_MEC_CT3"	ANAP	AUTO
CT Private Data 1	(7005,xx00)	OB		ANAP	AUTO
Cardiac R-R Mean Time	(7005,xx03)	SH	Ex.) "9999.9ms"	ANAP	AUTO
Cardiac Reconstruction Getting Phase in Percent	(7005,xx04)	SH	Ex.) "99%"	ANAP	AUTO
Cardiac Reconstruction Getting Phase in ms	(7005,xx05)	SH	Ex.) "999ms"	ANAP	AUTO
Cardiac Reconstruction Mode	(7005,xx06)	SH	"HALF", "SEGMENT"	ANAP	AUTO
Reconstruction Center	(7005,xx07)	DS		ANAP	AUTO
Detector Slice Thickness in mm	(7005,xx08)	DS	Ex.) "+9999.99"	ANAP	AUTO
Number of Detector rows to Reconstruct	(7005,xx09)	LO	Ex.) "0000111111110000" or "FFFF" 8 detectors were used to reconstruct image	ANAP	AUTO
Table Speed in mm/rot	(7005,xx0A)	DS	Ex.) "+99.99"	ANAP	AUTO
Filter	(7005,xx0B)	SH	Ex.) "ORG "	ANAP	AUTO
Reconstruction Correction Type	(7005,xx0C)	SH		ANAP	AUTO
Organ	(7005,xx0D)	CS	Typical organ in the Study.	ANAP	AUTO
File Type Remarks	(7005,xx0E)	SH	"IMG", "IMGRGB", "SCRN", "SCRNRBG"	ANAP	AUTO
Direction	(7005,xx0F)	SH	"HF", "FF", etc.	ANAP	AUTO
CT Private Data 2	(7005,xx10)	OB		ANAP	AUTO
Series Comment	(7005,xx11)	LT		ANAP	AUTO
Position	(7005,xx12)	SH	"SU", "PR", etc.	ANAP	AUTO

Expert Plan No.	(7005,xx13)	US		ANAP	AUTO
Volume UID	(7005,xx16)	UI		ANAP	AUTO
Total Frame Count in the Volume	(7005,xx17)	US		ANAP	AUTO
Frame No.	(7005,xx18)	US		ANAP	AUTO
Frame Sort Key	(7005,xx19)	UL		ANAP	AUTO
Frame Sort Order	(7005,xx1A)	US		ANAP	AUTO
Convolution Kernel for Series Record	(7005,xx1B)	SH	Ex.) "FL99" or "FC99"	ANAP	AUTO
Contrast/Bolus Agent for Series Record	(7005,xx1C)	LO		ANAP	AUTO
Group Key Information.	(7005,xx1D)	UL		ANAP	AUTO
Raw-data number (Sort Data)	(7005,xx1E)	UL		ANAP	AUTO
Volume file Number (Sort Data)	(7005,xx1F)	LO		ANAP	AUTO
Local Series Number (Sort Data)	(7005,xx20)	UL		ANAP	AUTO
Decrease in Artifact Filter	(7005,xx21)	LO	Ex.) "RASP", "BOOST"	ANAP	AUTO
Reconstruction Interval	(7005,xx22)	DS	Ex.) "7.00"	ANAP	AUTO
Pitch Factor	(7005,xx23)	DS	Ex.) "0.641"	ANAP	AUTO
The Acquisition Date of NRA	(7005,xx24)	DA	Ex.) "20051121"	ANAP	AUTO
Main Modality in Study	(7005,xx30)	CS	Ex.) "CT"	ANAP	AUTO
DLP (Dose Length Product)	(7005,xx40)	FD		ANAP	AUTO
Row Slice Information	(7005,xx41)	SH	Ex.) "0.5x64", "10.0x2", "1.0x1"	ANAP	AUTO

NOTE: CT Private Data 1 (7005,xx00) or CT Private Data 2 (7005,xx10) may contain some patient information.

8.1.1.12 Standalone Curve Modules

Table 8.1-31

CURVE IDENTIFICATION MODULE OF CREATED STANDALONE CURVE SOP INSTANCES

Attribute Name	Tag	VR	Value	Presence of Value	Source
Curve Number	(0020,0024)	IS		VNAP	AUTO
Curve Date	(0008,0025)	DA		ANAP	AUTO
Curve Time	(0028,0035)	TM		ANAP	AUTO
Referenced Image Sequence	(0008,1140)	SQ		ANAP	AUTO
>Referenced SOP Class UID	(0008,1150)	UI		ANAP	AUTO
> Referenced SOP Instance UID	(0008,1155)	UI		ANAP	AUTO
Referenced Overlay Sequence	(0008,1130)	SQ		ANAP	AUTO
>Referenced SOP Class UID	(0008,1150)	UI		ANAP	AUTO
> Referenced SOP Instance UID	(0008,1155)	UI		ANAP	AUTO
Referenced Curve Sequence	(0008,1145)	SQ		ANAP	AUTO
>Referenced SOP Class UID	(0008,1150)	UI		ANAP	AUTO
> Referenced SOP Instance UID	(0008,1155)	UI		ANAP	AUTO

**Table 8.1-32
CURVE MODULE OF CREATED STANDALONE CURVE SOP INSTANCES**

Attribute Name	Tag	VR	Value	Presence of Value	Source
Curve Dimensions	(50xx, 0005)	US		ALWAYS	AUTO
Number of Points	(50xx, 0010)	US		ALWAYS	AUTO
Type of Data	(50xx, 0020)	CS		ALWAYS	AUTO
Data Value Representation	(50xx, 0103)	US		ALWAYS	AUTO
Curve Data	(50xx, 3000)	OW or OB		ALWAYS	AUTO
Curve Description	(50xx, 0022)	LO		ANAP	AUTO
Axis Units	(50xx, 0030)	SH		ANAP	AUTO
Axis Labels	(50xx, 0040)	SH		ANAP	AUTO
Minimum Coordinate Value	(50xx, 0104)	US		ANAP	AUTO
Maximum Coordinate Value	(50xx, 0105)	US		ANAP	AUTO
Curve Range	(50xx, 0106)	SH		ANAP	AUTO
Curve Data Descriptor	(50xx, 0110)	US		ANAP	AUTO
Coordinate Start Value	(50xx, 0112)	US		ANAP	AUTO
Coordinate Step Value	(50xx, 0114)	US		ANAP	AUTO
Curve Label	(50xx, 2500)	LO		ANAP	AUTO
Referenced Overlay Sequence	(50xx,2600)	SQ		ANAP	AUTO
>Referenced SOP Class UID	(0008,1150)	UI		ANAP	AUTO
>Referenced SOP Instance UID	(0008,1155)	UI		ANAP	AUTO
>Referenced Overlay Group	(50xx, 2610)	US		ANAP	AUTO

**Table 8.1-33
SOP COMMON MODULE OF CREATED STANDALONE CURVE SOP INSTANCES**

Attribute Name	Tag	VR	Value	Presence of Value	Source
Specific Character set	(0008,0005)	CS	Refer to Section 6	ANAP	CONFIG
SOP Class UID	(0008,0016)	UI	"1.2.840.10008.5.1.4.1.1.9"	ALWAYS	AUTO
SOP Instance UID	(0008,0018)	UI	Generated by device	ALWAYS	AUTO

**Table 8.1-34
PRIVATE APPLICATION MODULE OF CREATED STANDALONE CURVE SOP INSTANCES**

Attribute Name	Tag	VR	Value	Presence of Value	Source
Private Creator Code	(7005,00xx)	LO	"TOSHIBA_MEC_CT3"	ANAP	AUTO
CT Private Data 1	(7005,xx00)	OB		ANAP	AUTO
Cardiac R-R Mean Time	(7005,xx03)	SH	Ex.) "9999.9ms"	ANAP	AUTO
Cardiac Reconstruction Getting Phase in Percent	(7005,xx04)	SH	Ex.) "99%"	ANAP	AUTO
Cardiac Reconstruction Getting Phase in ms	(7005,xx05)	SH	Ex.) "999ms"	ANAP	AUTO
Cardiac Reconstruction Mode	(7005,xx06)	SH	"HALF", "SEGMENT"	ANAP	AUTO
Reconstruction Center	(7005,xx07)	DS		ANAP	AUTO
Detector Slice Thickness in mm	(7005,xx08)	DS	Ex.) "+9999.99"	ANAP	AUTO
Number of Detector rows to Reconstruct	(7005,xx09)	LO	Ex.) "0000111111110000" or "FFFF" 8 detectors were used to reconstruct image	ANAP	AUTO
Table Speed in mm/rot	(7005,xx0A)	DS	Ex.) "+99.99"	ANAP	AUTO
Filter	(7005,xx0B)	SH	Ex.) "ORG "	ANAP	AUTO
Reconstruction Correction Type	(7005,xx0C)	SH		ANAP	AUTO
Organ	(7005,xx0D)	CS	Typical organ in the Study.	ANAP	AUTO
File Type Remarks	(7005,xx0E)	SH	"ROI", "CURVE"	ANAP	AUTO
CT Private Data 2	(7005,xx10)	OB		ANAP	AUTO
Series Comment	(7005,xx11)	LT		ANAP	AUTO
Volume UID	(7005,xx16)	UI		ANAP	AUTO
Total Frame Count in the Volume	(7005,xx17)	US		ANAP	AUTO
Frame No.	(7005,xx18)	US		ANAP	AUTO
Frame Sort Key	(7005,xx19)	UL		ANAP	AUTO
Frame Sort Order	(7005,xx1A)	US		ANAP	AUTO
Contrast/Bolus Agent for Series Record	(7005,xx1C)	LO		ANAP	AUTO
Group Key Information.	(7005,xx1D)	UL		ANAP	AUTO
Raw Data Number	(7005,xx1E)	UL		ANAP	AUTO
Volume Number	(7005,xx1F)	LO		ANAP	AUTO
Local Series Number	(7005,xx20)	UL		ANAP	AUTO
Decrease in Artifact Filter	(7005,xx21)	LO	Ex.) "RASP", "BOOST"	ANAP	AUTO
Reconstruction Interval	(7005,xx22)	DS	Ex.) "7.00"	ANAP	AUTO
Pitch Factor	(7005,xx23)	DS	Ex.) "0.641"	ANAP	AUTO

The Acquisition Date of NRA	(7005,xx24)	DA	Ex.) "20051121"	ANAP	AUTO
Main Modality in Study	(7005,xx30)	CS	Ex.) "CT"	ANAP	AUTO
DLP (Dose Length Product)	(7005,xx40)	FD		ANAP	AUTO
Row Slice Information	(7005,xx41)	SH	Ex.) "0.5x64", "10.0x2", "1.0x1"	ANAP	AUTO

NOTE: CT Private Data 1 (7005,xx00) or CT Private Data 2 (7005,xx10) may contain some patient information.

8.1.1.13 Enhanced CT Image Modules

Table 8.1-35

CT SERIES MODULE OF CREATED ENHANCED CT IMAGE SOP INSTANCES

Attribute Name	Tag	VR	Value	Presence of Value	Source
Modality	(0008,0060)	CS	"CT"	ALWAYS	AUTO
Referenced Performed Procedure Step Sequence	(0008,1111)	SQ		ANAP	
>Referenced SOP Class UID	(0008,1150)	UI		ANAP	
>Referenced SOP Instance UID	(0008,1155)	UI		ANAP	

Table 8.1-36

IMAGE PIXEL MODULE OF CREATED ENHANCED CT IMAGE SOP INSTANCES

Attribute Name	Tag	VR	Value	Presence of Value	Source
Include 'Image Pixel Macro' Table 8.1-70					

**Table 8.1-37
ENHANCED CONTRAST/BOLUS MODULE OF CREATED ENHANCED CT IMAGE SOP INSTANCES**

Attribute Name	Tag	VR	Value	Presence of Value	Source
Contrast/Bolus Agent Sequence	(0018,0012)	SQ		VNAP	USER
>Include 'Code Sequence Macro' Table 8.1-68			Baseline Context ID is 12.		
>Contrast/Bolus Agent Number	(0018,9337)	US		ANAP	AUTO
>Contrast/Bolus Administration Route Sequence	(0018,0014)	SQ		VNAP	USER
>>Include 'Code Sequence Macro' Table 8.1-68			Baseline Context ID is 11.		
>Contrast/Bolus Ingredient Code Sequence	(0018,9338)	SQ		EMPTY	
>>Include 'Code Sequence Macro' Table 8.1-68			Baseline Context ID is 13		
>Contrast/Bolus Volume	(0018,1041)	DS		VNAP	USER
>Contrast/Bolus Ingredient Concentration	(0018,1049)	DS		VNAP	USER

**Table 8.1-38
MULTI-FRAME FUNCTIONAL GROUPS MODULE OF CREATED ENHANCED CT IMAGE SOP
INSTANCES**

Attribute Name	Tag	VR	Value	Presence of Value	Source
Shared Functional Groups Sequence	(5200,9229)	SQ		ALWAYS	AUTO
>Include 'Pixel Measures Macro' Table 8.1-47					
>Include 'Referenced Image Macro' Table 8.1-51					
>Include 'Derivation Image Macro' Table 8.1-52					
>Include 'Frame Anatomy Macro' Table 8.1-55					
>Include 'Frame VOI LUT Macro' Table 8.1-56					
>Include 'Contrast/Bolus Usage Macro' Table 8.1-57					
>Include 'CT Image Frame Type Macro' Table 8.1-58					
>Include 'CT Acquisition Type Macro' Table 8.1-59					
>Include 'CT Acquisition Details Macro' Table 8.1-60					
>Include 'CT Table Dynamics Macro' Table 8.1-61					
>Include 'CT Geometry Macro' Table 8.1-63					
>Include 'CT Reconstruction Macro' Table 8.1-64					
>Include 'CT X-ray Details Macro' Table 8.1-66					
>Include 'CT Pixel Value Transformation Macro' Table 8.1-67					
Per-frame Functional Groups Sequence	(5200,9230)	SQ		ALWAYS	AUTO
>Include 'Frame Content Macro' Table 8.1-48					
>Include 'Plane Position Macro' Table 8.1-49					
>Include 'Plane Orientation Macro' Table 8.1-50					
>Include 'Cardiac Trigger Macro' Table 8.1-53					
>Include 'Respiratory Trigger Macro' Table 8.1-54					
>Include 'CT Position Macro' Table 8.1-62					
>Include 'CT Exposure Functional Macro' Table 8.1-65					
>Include 'Enhanced CT Private Macro' Table 8.1-72					
Instance Number	(0020,0013)	IS		ALWAYS	AUTO
Content Date	(0008,0023)	DA		ALWAYS	AUTO
Content Time	(0008,0033)	TM		ALWAYS	AUTO
Number of Frames	(0028,0008)	IS		ALWAYS	AUTO

Table 8.1-39

MULTI-FRAME DIMENSION MODULE OF CREATED ENHANCED CT IMAGE SOP INSTANCES

Attribute Name	Tag	VR	Value	Presence of Value	Source
Dimension Organization Sequence	(0020,9221)	SQ		ANAP	AUTO
>Dimension Organization UID	(0020,9164)	UI		ANAP	AUTO
Dimension Index Sequence	(0020,9222)	SQ		ANAP	AUTO
>Dimension Index Pointer	(0020,9165)	AT		ANAP	AUTO
>Functional Group Pointer	(0020,9167)	AT		ANAP	AUTO
>Dimension Organization UID	(0020,9164)	UI		ANAP	AUTO

Table 8.1-40

CARDIAC SYNCHRONIZATION MODULE OF CREATED ENHANCED CT IMAGE SOP INSTANCES

Attribute Name	Tag	VR	Value	Presence of Value	Source
Cardiac Synchronization Technique	(0018,9037)	CS	"RETROSPECTIVE"	ALWAYS	AUTO
Cardiac Signal Source	(0018,9085)	CS	"ECG"	ALWAYS	AUTO
Cardiac RR Interval Specified	(0018,9070)	FD		ALWAYS	AUTO
Cardiac Beat Rejection Technique	(0018,9169)	CS	"RR_INTERVAL"	ALWAYS	AUTO
Low R-R Value	(0018,1081)	IS		EMPTY	
High R-R Value	(0018,1082)	IS		EMPTY	
Intervals Acquired	(0018,1083)	IS		EMPTY	
Intervals Rejected	(0018,1084)	IS		EMPTY	

Table 8.1-41

RESPIRATORY SYNCHRONIZATION MODULE OF CREATED ENHANCED CT IMAGE SOP INSTANCES

Attribute Name	Tag	VR	Value	Presence of Value	Source
Respiratory Motion Compensation Technique	(0018,9170)	CS	Ex.) "RETRO SPECTIVE", "GATING"	ANAP	AUTO
Respiratory Signal Source	(0018,9171)	CS	Ex.) "RESP_MONITOR"	ANAP	AUTO
Respiratory Trigger Delay Threshold	(0020,9256)	FD		ANAP	AUTO

Table 8.1-42
ACQUISITION CONTEXT MODULE OF CREATED ENHANCED CT IMAGE SOP INSTANCES

Attribute Name	Tag	VR	Value	Presence of Value	Source
Acquisition Context Sequence	(0040,0555)	SQ		EMPTY	

Table 8.1-43
ENHANCED CT IMAGE MODULE OF CREATED ENHANCED CT IMAGE SOP INSTANCES

Attribute Name	Tag	VR	Value	Presence of Value	Source
Image Type	(0008,0008)	CS	"ORIGINAL¥PRIMARY¥CARDIAC" "ORIGINAL¥PRIMARY¥CARDIAC_CTA" "ORIGINAL¥PRIMARY¥CARDIAC_DYNAMIC" "ORIGINAL¥PRIMARY¥CARDIAC_PHASE" "ORIGINAL¥PRIMARY¥AXIAL" "ORIGINAL¥PRIMARY¥DYNAMIC" "ORIGINAL¥PRIMARY¥PERFUSION" "ORIGINAL¥PRIMARY¥VOLUME" "DERIVED¥PRIMARY¥AXIAL" "DERIVED¥SECONDERY¥AXIAL¥REGISTRATION" "DERIVED¥SECONDERY¥SUBTRACTION" "DERIVED¥SECONDERY¥SUBTRACTION_BASE"	ALWAYS	AUTO
Include Common CT/MR Image Description Macro' Table 8.1-69					
Acquisition Number	(0020,0012)	IS		ALWAYS	AUTO
Acquisition Datetime	(0008,002A)	DT		ANAP	AUTO
Acquisition Duration	(0018,9073)	FD		VNAP	AUTO
Samples per Pixel	(0028,0002)	US	1	ALWAYS	AUTO
Photometric Interpretation	(0028,0004)	CS	"MONOCHROME2"	ALWAYS	AUTO
Bits Allocated	(0028,0100)	US	16	ALWAYS	AUTO
Bits Stored	(0028,0101)	US	16	ALWAYS	AUTO
High Bit	(0028,0102)	US	15	ALWAYS	AUTO
Content Qualification	(0018,9004)	CS	"PRODUCT"	ALWAYS	AUTO
Image Comments	(0020,4000)	LT		ANAP	USER

Table 8.1-44

SOFTCOPY PRESENTATION LUT MODULE OF CREATED ENHANCED CT IMAGE SOP INSTANCES

Attribute Name	Tag	VR	Value	Presence of Value	Source
Presentation LUT Shape	(2050,0020)	CS	"IDENTIFY"	ALWAYS	AUTO

Table 8.1-45

SOP COMMON MODULE OF CREATED ENHANCED CT IMAGE SOP INSTANCES

Attribute Name	Tag	VR	Value	Presence of Value	Source
Specific Character set	(0008,0005)	CS	Refer to Section 6	ANAP	CONFIG
SOP Class UID	(0008,0016)	UI	"1.2.840.10008.5.1.4.1.1.2.1"	ALWAYS	AUTO
SOP Instance UID	(0008,0018)	UI	Generated by device	ALWAYS	AUTO

Table 8.1-46

PRIVATE APPLICATION MODULE OF CREATED ENHANCED CT IMAGE SOP INSTANCES

Attribute Name	Tag	VR	Value	Presence of Value	Source
Private Creator Code	(7005,00xx)	LO	"TOSHIBA_MEC_CT3"	ANAP	AUTO
CT Private Data 1	(7005,xx00)	OB		ANAP	AUTO
Cardiac Reconstruction Getting Phase in Percent	(7005,xx04)	SH	Ex.) "99%"	ANAP	AUTO
Cardiac Reconstruction Getting Phase in ms	(7005,xx05)	SH	Ex.) "999ms"	ANAP	AUTO
Cardiac Reconstruction Mode	(7005,xx06)	SH	"HALF", "SEGMENT"	ANAP	AUTO
Reconstruction Center	(7005,xx07)	DS		ANAP	AUTO
Detector Slice Thickness in mm	(7005,xx08)	DS	Ex.) "+9999.99"	ANAP	AUTO
Number of Detector rows to Reconstruct	(7005,xx09)	LO	Ex.) "0000111111110000" or "FFFF" 8 detectors were used to reconstruct image	ANAP	AUTO
Table Speed in mm/rot	(7005,xx0A)	DS	Ex.) "+99.99"	ANAP	AUTO
Filter	(7005,xx0B)	SH	Ex.) "ORG "	ANAP	AUTO
Reconstruction Correction Type	(7005,xx0C)	SH		ANAP	AUTO
Organ	(7005,xx0D)	CS	Typical organ in the Study.	ANAP	AUTO
File Type Remarks	(7005,xx0E)	SH	"IMG"	ANAP	AUTO
Direction	(7005,xx0F)	SH	"HF", "FF", etc.	ANAP	AUTO
CT Private Data 2	(7005,xx10)	OB		ANAP	AUTO
Series Comment	(7005,xx11)	LT		ANAP	AUTO
Position	(7005,xx12)	SH	"SU", "PR", etc.	ANAP	AUTO
Expert Plan No.	(7005,xx13)	US		ANAP	AUTO
Reconstruction ROI No.	(7005,xx14)	US		ANAP	AUTO
Special Helical ACQ No.	(7005,xx15)	US		ANAP	AUTO
Volume UID	(7005,xx16)	UI		ANAP	AUTO

Total Frame Count in the Volume	(7005,xx17)	US		ANAP	AUTO
Frame Sort Key	(7005,xx19)	UL		ANAP	AUTO
Frame Sort Order	(7005,xx1A)	US		ANAP	AUTO
Convolution Kernel for Series Record	(7005,xx1B)	SH	Ex.) "FL99" or "FC99"	ANAP	AUTO
Contrast/Bolus Agent for Series Record	(7005,xx1C)	LO		ANAP	AUTO
Reconstruction Number	(7005,xx1D)	UL		ANAP	AUTO
Raw Data Number	(7005,xx1E)	UL		ANAP	AUTO
Volume Number	(7005,xx1F)	LO		ANAP	AUTO
Local Series Number	(7005,xx20)	UL		ANAP	AUTO
Decrease in Artifact Filter	(7005,xx21)	LO	Ex.) "RASP", "BOOST"	ANAP	AUTO
Reconstruction Interval	(7005,xx22)	DS	Ex.) "7.00"	ANAP	AUTO
Pitch Factor	(7005,xx23)	DS	Ex.) "0.641"	ANAP	AUTO
The Acquisition Date of NRA	(7005,xx24)	DA	Ex.) "20051121"	ANAP	AUTO
Main Modality in Study	(7005,xx30)	CS	"CT"	ANAP	AUTO
Scan Range	(7005,xx35)	DS		ANAP	AUTO
CT Private Data 3	(7005,xx36)	OB		ANAP	AUTO
Total Frames	(7005,xx37)	IS		ANAP	AUTO
Start Frame	(7005,xx38)	IS		ANAP	AUTO
End Frame	(7005,xx39)	IS		ANAP	AUTO
DLP (Dose Length Product)	(7005,xx40)	FD		ANAP	AUTO
Row Slice Information	(7005,xx41)	SH	Ex.) "0.5x64", "10.0x2", "1.0x1"	ANAP	AUTO
Volume Vector	(7005,xx43)	DS		ANAP	AUTO
Volume Type	(7005,xx44)	US		ANAP	AUTO
Relative Table Position of 4D Volume	(7005,xx45)	DS		ANAP	AUTO
Absolute Table Position of 4D Volume	(7005,xx46)	DS		ANAP	AUTO
Slice Pitch of 4D Volume	(7005,xx47)	DS		ANAP	AUTO
Basis Material of Raw Data DE	(7005,xx7b)	LO		ANAP	AUTO

NOTE: CT Private Data 1 (7005,xx00) or CT Private Data 2 (7005,xx10) may contain some patient information.

Table 8.1-47

PIXEL MEASURES MACRO OF CREATED ENHANCED CT IMAGE SOP INSTANCES

Attribute Name	Tag	VR	Value	Presence of Value	Source
Pixel Measures Sequence	(0028,9110)	SQ		ALWAYS	AUTO
>Pixel Spacing	(0028,0030)	DS		ALWAYS	AUTO
>Slice Thickness	(0018,0050)	DS		ALWAYS	AUTO

Table 8.1-48

FRAME CONTENT MACRO OF CREATED ENHANCED CT IMAGE SOP INSTANCES

Attribute Name	Tag	VR	Value	Presence of Value	Source
Frame Content Sequence	(0020,9111)	SQ		ALWAYS	AUTO
>Frame Reference Datetime	(0018,9151)	DT		ALWAYS	AUTO
>Frame Acquisition Datetime	(0018,9074)	DT		ALWAYS	AUTO
>Frame Acquisition Duration	(0018,9220)	FD		ALWAYS	AUTO
>Dimension Index Values	(0020,9157)	UL		ANAP	AUTO
>Temporal Position Index	(0020,9128)	UL		ANAP	AUTO
>Stack ID	(0020,9056)	SH		ANAP	AUTO
>In-Stack Position Number	(0020,9057)	UL		ANAP	AUTO

Table 8.1-49

PLANE POSITION MACRO OF CREATED ENHANCED CT IMAGE SOP INSTANCES

Attribute Name	Tag	VR	Value	Presence of Value	Source
Plane Position Sequence	(0020,9113)	SQ		ALWAYS	AUTO
>Image Position (Patient)	(0020,0032)	DS		ALWAYS	AUTO

**Table 8.1-50
PLANE ORIENTATION MACRO OF CREATED ENHANCED CT IMAGE SOP INSTANCES**

Attribute Name	Tag	VR	Value	Presence of Value	Source
Plane Orientation Sequence	(0020,9116)	SQ		ALWAYS	AUTO
>Image Orientation (Patient)	(0020,0037)	DS		ALWAYS	AUTO

**Table 8.1-51
REFERENCED IMAGE MACRO OF CREATED ENHANCED CT IMAGE SOP INSTANCES**

Attribute Name	Tag	VR	Value	Presence of Value	Source
Referenced Image Sequence	(0008,1140)	SQ		EMPTY	

**Table 8.1-52
DERIVATION IMAGE MACRO OF CREATED ENHANCED CT IMAGE SOP INSTANCES**

Attribute Name	Tag	VR	Value	Presence of Value	Source
Derivation Image Sequence	(0008,9124)	SQ		EMPTY	

**Table 8.1-53
CARDIAC TRIGGER MACRO OF CREATED ENHANCED CT IMAGE SOP INSTANCES**

Attribute Name	Tag	VR	Value	Presence of Value	Source
Cardiac Trigger Sequence	(0018,9118)	SQ		ANAP	AUTO
>Trigger Delay Time	(0020,9153)	FD		ANAP	AUTO

**Table 8.1-54
RESPIRATORY TRIGGER MACRO OF CREATED ENHANCED CT IMAGE SOP INSTANCES**

Attribute Name	Tag	VR	Value	Presence of Value	Source
Respiratory Trigger Sequence	(0020,9253)	SQ		ANAP	AUTO
>Respiratory Interval Time	(0020,9254)	FD		ANAP	AUTO
>Respiratory Trigger Delay Time	(0020,9255)	FD		ANAP	AUTO

**Table 8.1-55
FRAME ANATOMY MACRO OF CREATED ENHANCED CT IMAGE SOP INSTANCES**

Attribute Name	Tag	VR	Value	Presence of Value	Source
Frame Anatomy Sequence	(0020,9071)	SQ		ALWAYS	AUTO
>Frame Laterality	(0020,9072)	CS	"U"	ALWAYS	AUTO
>Include 'General Anatomy Required Macro' Table 8.1-71					

**Table 8.1-56
FRAME VOI LUT MACRO OF CREATED ENHANCED CT IMAGE SOP INSTANCES**

Attribute Name	Tag	VR	Value	Presence of Value	Source
Frame VOI LUT Sequence	(0028,9132)	SQ		ALWAYS	AUTO
>Window Center	(0028,1050)	DS		ALWAYS	USER or AUTO
>Window Width	(0028,1051)	DS		ALWAYS	USER or AUTO

**Table 8.1-57
CONTRAST/BOLUS USAGE MACRO OF CREATED ENHANCED CT IMAGE SOP INSTANCES**

Attribute Name	Tag	VR	Value	Presence of Value	Source
Contrast/Bolus Usage Sequence	(0018,9341)	SQ		ALWAYS	AUTO
>Contrast/Bolus Agent Number	(0018,9337)	US		ALWAYS	AUTO
>Contrast/Bolus Agent Administered	(0018,9342)	CS	"YES"	ALWAYS	AUTO
>Contrast/Bolus Agent Detected	(0018,9343)	CS		VNAP	AUTO
>Contrast/Bolus Agent Phase	(0018,9344)	CS		VNAP	AUTO

**Table 8.1-58
CT IMAGE FRAME TYPE MACRO OF CREATED ENHANCED CT IMAGE SOP INSTANCES**

Attribute Name	Tag	VR	Value	Presence of Value	Source
CT Image Frame Type Sequence	(0018,9329)	SQ		ALWAYS	AUTO
>Frame Type	(0008,9007)	CS	"ORIGINAL¥PRIMARY¥CARDIAC" "ORIGINAL¥PRIMARY¥CARDIAC_CTA" "ORIGINAL¥PRIMARY¥CARDIAC_DYNAMIC" "ORIGINAL¥PRIMARY¥CARDIAC_PHASE" "ORIGINAL¥PRIMARY¥AXIAL" "ORIGINAL¥PRIMARY¥DYNAMIC" "ORIGINAL¥PRIMARY¥PERFUSION" "ORIGINAL¥PRIMARY¥VOLUME" "DERIVED¥PRIMARY¥AXIAL" "DERIVED¥SECONDERY¥AXIAL¥REGISTRATION" "DERIVED¥SECONDERY¥SUBREACTION" "DERIVED¥SECONDERY¥SUBREACTION_BASE"	ALWAYS	AUTO
>Include Common CT/MR Image Description Macro' Table 8.1-69					

**Table 8.1-59
CT ACQUISITION TYPE MACRO OF CREATED ENHANCED CT IMAGE SOP INSTANCES**

Attribute Name	Tag	VR	Value	Presence of Value	Source
CT Acquisition Type Sequence	(0018,9301)	SQ		ALWAYS	AUTO
>Acquisition Type	(0018,9302)	CS		ALWAYS	AUTO
>Tube Angle	(0018,9303)	FD		ANAP	AUTO
>Constant Volume Flag	(0018,9333)	CS	"NO"	ALWAYS	AUTO
>Fluoroscopy Flag	(0018,9334)	CS		ALWAYS	AUTO

Table 8.1-60

CT ACQUISITION DETAILS MACRO OF CREATED ENHANCED CT IMAGE SOP INSTANCES

Attribute Name	Tag	VR	Value	Presence of Value	Source
CT Acquisition Details Sequence	(0018,9304)	SQ		ALWAYS	AUTO
>Rotation Direction	(0018,1140)	CS	"CW", "CC"	ALWAYS	AUTO
>Revolution Time	(0018,9305)	FD		ALWAYS	AUTO
>Single Collimation Width	(0018,9306)	FD		ALWAYS	AUTO
>Total Collimation Width	(0018,9307)	FD		ALWAYS	AUTO
>Table Height	(0018,1130)	DS		ALWAYS	AUTO
>Gantry/Detector Tilt	(0018,1120)	DS		ALWAYS	AUTO
>Data Collection Diameter	(0018,0090)	DS		ALWAYS	AUTO

Table 8.1-61

CT TABLE DYNAMICS MACRO OF CREATED ENHANCED CT IMAGE SOP INSTANCES

Attribute Name	Tag	VR	Value	Presence of Value	Source
CT Table Dynamics Sequence	(0018,9308)	SQ		ALWAYS	AUTO
>Table Speed	(0018,9309)	FD		ALWAYS	AUTO
>Table Feed per Rotation	(0018,9310)	FD		ALWAYS	AUTO
>Spiral Pitch Factor	(0018,9311)	FD		EMPTY	

Table 8.1-62

CT POSITION MACRO OF CREATED ENHANCED CT IMAGE SOP INSTANCES

Attribute Name	Tag	VR	Value	Presence of Value	Source
CT Position Sequence	(0018,9326)	SQ		ALWAYS	AUTO
>Table Position	(0018,9327)	FD		ALWAYS	AUTO
>Data Collection Center (Patient)	(0018,9313)	FD		ALWAYS	AUTO
>Reconstruction Target Center (Patient)	(0018,9318)	FD		ALWAYS	AUTO

Table 8.1-63

CT GEOMETRY MACRO OF CREATED ENHANCED CT IMAGE SOP INSTANCES

Attribute Name	Tag	VR	Value	Presence of Value	Source
CT Geometry Sequence	(0018,9312)	SQ		ALWAYS	AUTO
>Distance Source to Detector	(0018,1110)	DS	Value may not be correct.	ALWAYS	AUTO
>Distance Source to Data Collection Center	(0018,9335)	FD	Value may not be correct.	ALWAYS	AUTO

Table 8.1-64
CT RECONSTRUCTION MACRO OF CREATED ENHANCED CT IMAGE SOP INSTANCES

Attribute Name	Tag	VR	Value	Presence of Value	Source
CT Reconstruction Sequence	(0018,9314)	SQ		ALWAYS	AUTO
>Reconstruction Algorithm	(0018,9315)	CS	Example "INTERP_99"	ALWAYS	AUTO
>Convolution Kernel	(0018,1210)	SH	Example "FC99" "FL99"	ALWAYS	AUTO
>Convolution Kernel Group	(0018,9316)	CS		EMPTY	
>Reconstruction Diameter	(0018,1100)	DS		ALWAYS	AUTO
>Reconstruction Pixel Spacing	(0018,9322)	FD		ALWAYS	AUTO
>Reconstruction Angle	(0018,9319)	FD		EMPTY	
>Image Filter	(0018,9320)	SH		ALWAYS	AUTO

Table 8.1-65
CT EXPOSURE MACRO OF CREATED ENHANCED CT IMAGE SOP INSTANCES

Attribute Name	Tag	VR	Value	Presence of Value	Source
CT Exposure Sequence	(0018,9321)	SQ		ALWAYS	AUTO
>Exposure Time in ms	(0018,9328)	FD		ALWAYS	AUTO
>X-ray Tube Current in mA	(0018,9330)	FD		ALWAYS	AUTO
>Exposure in mAs	(0018,9332)	FD		ALWAYS	AUTO
>Exposure Modulation Type	(0018,9323)	CS	"NONE"	ALWAYS	AUTO
>Estimated Dose Saving	(0018,9324)	FD		VNAP	AUTO
>CTDIvol	(0018,9345)	FD		VNAP	AUTO

**Table 8.1-66
CT X-RAY DETAILS MACRO OF CREATED ENHANCED CT IMAGE SOP INSTANCES**

Attribute Name	Tag	VR	Value	Presence of Value	Source
CT X-ray Details Sequence	(0018,9325)	SQ		ALWAYS	AUTO
>KVP	(0018,0060)	DS		ALWAYS	AUTO
>Focal Spot(s)	(0018,1190)	DS		ALWAYS	AUTO
>Filter Type	(0018,1160)	SH	"NONE"	ALWAYS	AUTO
>Filter Material	(0018,7050)	CS	"COPPER"	ALWAYS	AUTO

**Table 8.1-67
CT PIXEL VALUE TRANSFORMATION MACRO OF CREATED ENHANCED CT IMAGE SOP INSTANCES**

Attribute Name	Tag	VR	Value	Presence of Value	Source
Pixel Value Transformation Sequence	(0028,9145)	SQ		ALWAYS	AUTO
>Rescale Intercept	(0028,1052)	DS		ALWAYS	AUTO
>Rescale Slope	(0028,1053)	DS		ALWAYS	AUTO
>Rescale Type	(0028,1054)	LO	"HU", "US"	ALWAYS	AUTO

**Table 8.1-68
CODE SEQUENCE MACRO OF CREATED ENHANCED CT IMAGE SOP INSTANCES**

Attribute Name	Tag	VR	Value	Presence of Value	Source
Code Value	(0008,0100)	SH		VNAP	USER
Coding Scheme Designator	(0008,0102)	SH		VNAP	USER
Coding Scheme Version	(0008,0103)	SH		VNAP	USER

**Table 8.1-69
COMMON CT/MR IMAGE DESCRIPTION MACRO OF CREATED ENHANCED CT IMAGE SOP INSTANCES**

Attribute Name	Tag	VR	Value	Presence of Value	Source
Pixel Presentation	(0008,9205)	CS	"MONOCHROME"	ALWAYS	AUTO
Volumetric Properties	(0008,9206)	CS	"VOLUME"	ALWAYS	AUTO
Volume Based Calculation Technique	(0008,9207)	CS	"NONE"	ALWAYS	AUTO

**Table 8.1-70
IMAGE PIXEL MACRO OF CREATED ENHANCED CT IMAGE SOP INSTANCES**

Attribute Name	Tag	VR	Value	Presence of Value	Source
Samples per Pixel	(0028,0002)	US	1	ALWAYS	AUTO
Photometric Interpretation	(0028,0004)	CS	"MONOCHROME2"	ALWAYS	AUTO
Rows	(0028,0010)	US		ALWAYS	AUTO
Columns	(0028,0011)	US		ALWAYS	AUTO
Bits Allocated	(0028,0100)	US	16	ALWAYS	AUTO
Bits Stored	(0028,0101)	US	16	ALWAYS	AUTO
High Bit	(0028,0102)	US	15	ALWAYS	AUTO
Pixel Representation	(0028,0103)	US	1	ALWAYS	AUTO
Pixel Data	(7FE0,0010)	OB or OW		ALWAYS	AUTO
Smallest Image Pixel Value	(0028,0106)	US or SS		ANAP	AUTO
Largest Image Pixel Value	(0028,0107)	US or SS		ANAP	AUTO

**Table 8.1-71
GENERAL ANATOMY REQUIRED MACRO OF CREATED ENHANCED CT IMAGE SOP INSTANCES**

Attribute Name	Tag	VR	Value	Presence of Value	Source
Anatomic Region Sequence	(0008,2218)	SQ		EMPTY	

**Table 8.1-72
ENHANCED CT PRIVATE MACRO OF CREATED ENHANCED CT IMAGE SOP INSTANCES**

Attribute Name	Tag	VR	Value	Presence of Value	Source
Enhanced CT Private Sequence	(7005,xx28)	SQ		ANAP	AUTO
>Frame UID	(7005,xx29)	UI		ANAP	AUTO
>Local Frame No.	(7005,xx42)	US		ANAP	AUTO
> Stitching	(7005,xx6e)	SH		ANAP	AUTO
>Injector Elapsed Time	(7005,xx79)	SH		ANAP	AUTO

8.1.1.14 Grayscale Softcopy Presentation State Modules

Table 8.1-73

PRESENTATION SERIES MODULE OF CREATED GRAYSCALE SOFTCOPY PRESENTATION STATE SOP INSTANCES

Attribute Name	Tag	VR	Value	Presence of Value	Source
Modality	(0008,0060)	CS	PR	ALWAYS	AUTO

Table 8.1-74

PRESENTATION STATE MODULE OF CREATED GRAYSCALE SOFTCOPY PRESENTATION STATE SOP INSTANCES

Attribute Name	Tag	VR	Value	Presence of Value	Source
Instance Number	(0020,0013)	IS	Generated by device	ALWAYS	AUTO
Presentation Label	(0070,0080)	CS	Generated by device	ALWAYS	AUTO
Presentation Description	(0070,0081)	LO		VNAP	USER
Presentation Creation Date	(0070,0082)	DA	<yyyymmdd>	ALWAYS	AUTO
Presentation Creation Time	(0070,0083)	TM	<hhmmss.frac>	ALWAYS	AUTO
Presentation Creator's Name	(0070,0084)	PN		VNAP	USER
Presentation Series Sequence	(0008,1115)	SQ		ALWAYS	AUTO
>Series Instance UID	(0020,000E)	UI		ALWAYS	AUTO
>Referenced Image Sequence	(0008,1140)	SQ		ALWAYS	AUTO
>>Referenced SOP Class UID	(0008,1150)	UI		ALWAYS	AUTO
>>Referenced SOP Instance UID	(0008,1155)	UI		ALWAYS	AUTO

Table 8.1-75
DISPLAYED AREA MODULE OF CREATED GRAYSCALE SOFTCOPY PRESENTATION STATE SOP
INSTANCES

Attribute Name	Tag	VR	Value	Presence of Value	Source
Displayed Area Selection Sequence	(0070,005A)	SQ		ALWAYS	AUTO
>Referenced Image Sequence	(0008,1140)	SQ		ANAP	AUTO
>>Referenced SOP Class UID	(0008,1150)	UI		ANAP	AUTO
>>Referenced SOP Instance UID	(0008,1155)	UI		ANAP	AUTO
>Displayed Area Top Left Hand Corner	(0070,0052)	SL		ALWAYS	AUTO
>Displayed Area Bottom Right Hand Corner	(0070,0053)	SL		ALWAYS	AUTO
>Presentation Size Model	(0070,0100)	CS		ALWAYS	AUTO
>Presentation Pixel Aspect Ratio	(0070,0102)	IS		ALWAYS	AUTO
>Presentation Pixel Magnification Ratio	(0070,0103)	FL		ANAP	AUTO

Table 8.1-76
SPATIAL TRANSFORMATION MODULE OF CREATED GRAYSCALE SOFTCOPY PRESENTATION
STATE SOP INSTANCES

Attribute Name	Tag	VR	Value	Presence of Value	Source
Image Horizontal Flip	(0070,0041)	CS		ALWAYS	AUTO
Image Rotation	(0070,0042)	US		ALWAYS	AUTO

Table 8.1-77
MODALITY LUT MODULE OF CREATED GRAYSCALE SOFTCOPY PRESENTATION STATE SOP
INSTANCES

Attribute Name	Tag	VR	Value	Presence of Value	Source
Rescale Intercept	(0028,1052)	DS		ANAP	AUTO
Rescale Slope	(0028,1053)	DS		ANAP	AUTO
Rescale Type	(0028,1054)	LO		ANAP	AUTO

Table 8.1-78
SOFTCOPY VOI LUT MODULE OF CREATED GRAYSCALE SOFTCOPY PRESENTATION STATE SOP INSTANCES

Attribute Name	Tag	VR	Value	Presence of Value	Source
Softcopy VOI LUT Sequence	(0028,3110)	SQ		ALWAYS	AUTO
>Referenced Image Sequence	(0008,1140)	SQ		ALWAYS	AUTO
>>Referenced SOP Class UID	(0008,1150)	UI		ALWAYS	AUTO
>>Referenced SOP Instance UID	(0008,1155)	UI		ALWAYS	AUTO
>Window Center	(0028,1050)	DS		ALWAYS	AUTO
>Window Width	(0028,1051)	DS		ALWAYS	AUTO
>Window Center & Width Explanation	(0028,1055)	LO		ANAP	AUTO

Table 8.1-79
SOFTCOPY PRESENTATION LUT MODULE OF CREATED GRAYSCALE SOFTCOPY PRESENTATION STATE SOP INSTANCES

Attribute Name	Tag	VR	Value	Presence of Value	Source
Presentation LUT Shape	(2050,0020)	CS		ALWAYS	AUTO

Table 8.1-80
SOP COMMON MODULE OF CREATED GRAYSCALE SOFTCOPY PRESENTATION STATE SOP INSTANCES

Attribute Name	Tag	VR	Value	Presence of Value	Source
Specific Character Set	(0008,0005)	CS	Refer to Section 6	ANAP	AUTO
Instance Creation Date	(0008,0012)	DA	<yyyymmdd>	ANAP	AUTO
Instance Creation Time	(0008,0013)	TM	<hhmmss.frac>	ANAP	AUTO
SOP Class UID	(0008,0016)	UI	"1.2.840.10008.5.1.4.1.1.11.1"	ALWAYS	AUTO
SOP Instance UID	(0008,0018)	UI	Generated by device	ALWAYS	AUTO

**Table 8.1-81
PRIVATE APPLICATION MODULE OF CREATED GRAYSCALE SOFTCOPY PRESENTATION STATE
SOP INSTANCES**

Attribute Name	Tag	VR	Value	Presence of Value	Source
Private Creator Code	(7005,00xx)	LO	"TOSHIBA_MEC_CT3"	ANAP	AUTO
CT Private Data 1	(7005,xx00)	OB		ANAP	AUTO
Cardiac R-R Mean Time	(7005,xx03)	SH	Ex.) "9999.9ms"	ANAP	AUTO
Cardiac Reconstruction Getting Phase in Percent	(7005,xx04)	SH	Ex.) "99%"	ANAP	AUTO
Cardiac Reconstruction Getting Phase in ms	(7005,xx05)	SH	Ex.) "999ms"	ANAP	AUTO
Cardiac Reconstruction Mode	(7005,xx06)	SH	"HALF", "SEGMENT"	ANAP	AUTO
Reconstruction Center	(7005,xx07)	DS		ANAP	AUTO
Detector Slice Thickness in mm	(7005,xx08)	DS	Ex.) "+9999.99"	ANAP	AUTO
Number of Detector rows to Reconstruct	(7005,xx09)	LO	Ex.) "0000111111110000" or "FFFF" 8 detectors were used to reconstruct image	ANAP	AUTO
Table Speed in mm/rot	(7005,xx0A)	DS	Ex.) "+99.99"	ANAP	AUTO
Filter	(7005,xx0B)	SH	Ex.) "ORG "	ANAP	AUTO
Reconstruction Correction Type	(7005,xx0C)	SH		ANAP	AUTO
Organ	(7005,xx0D)	CS	Typical organ in the Study.	ANAP	AUTO
File Type Remarks	(7005,xx0E)	SH	"PGP"	ANAP	AUTO
CT Private Data 2	(7005,xx10)	OB		ANAP	AUTO
Series Comment	(7005,xx11)	LT		ANAP	AUTO
Position	(7005,xx12)	SH	"SU", "PR", etc.	ANAP	AUTO
Expert Plan No.	(7005,xx13)	US		ANAP	AUTO
Reconstruction ROI No.	(7005,xx14)	US		ANAP	AUTO
Special Helical ACQ No.	(7005,xx15)	US		ANAP	AUTO
Volume UID	(7005,xx16)	UI		ANAP	AUTO
Total Frame Count in the Volume	(7005,xx17)	US		ANAP	AUTO
Frame No.	(7005,xx18)	US		ANAP	AUTO
Frame Sort Key	(7005,xx19)	UL		ANAP	AUTO
Frame Sort Order	(7005,xx1A)	US		ANAP	AUTO
Convolution Kernel for Series Record	(7005,xx1B)	SH	Ex.) "FL99" or "FC99"	VNAP	AUTO
Contrast/Bolus Agent for Series Record	(7005,xx1C)	LO		VNAP	AUTO
Reconstruction Number	(7005,xx1D)	UL		ANAP	AUTO
Raw Data Number	(7005,xx1E)	UL		ANAP	AUTO
Volume Number	(7005,xx1F)	LO		ANAP	AUTO
Local Series Number	(7005,xx20)	UL		ANAP	AUTO

Decrease in Artifact Filter	(7005,xx21)	LO	Ex.) "RASP", "BOOST"	ANAP	AUTO
Reconstruction Interval	(7005,xx22)	DS	Ex.) "7.00"	ANAP	AUTO
Pitch Factor	(7005,xx23)	DS	Ex.) "0.641"	ANAP	AUTO
The Acquisition Date of NRA	(7005,xx24)	DA	Ex.) "20051121"	ANAP	AUTO
Main Modality in Study	(7005,xx30)	CS	Ex.) "CT"	ANAP	AUTO
DLP (Dose Length Product)	(7005,xx40)	FD		ANAP	AUTO
Row Slice Information	(7005,xx41)	SH	Ex.) "0.5x64", "10.0x2", "1.0x1"	ANAP	AUTO

NOTE: CT Private Data 1 (7005,xx00) or CT Private Data 2 (7005,xx10) may contain some patient information.

8.1.1.15 Enhanced SR Modules

Table 8.1-82
SR SERIES MODULE OF CREATED ENHANCED SR SOP INSTANCES

Attribute Name	Tag	VR	Value	Presence of Value	Source
Modality	(0008,0060)	CS	SR	ALWAYS	AUTO
Referenced Study Component Sequence	(0008,1111)	SQ		VNAP	AUTO
Series Instance UID	(0020,000E)	UI		ALWAYS	AUTO
Series Number	(0020,0011)	IS		ALWAYS	AUTO

Table 8.1-83
SR DOCUMENT GENERAL MODULE OF CREATED ENHANCED SR SOP INSTANCES

Attribute Name	Tag	VR	Value	Presence of Value	Source
Content Date	(0008,0023)	DA		ALWAYS	AUTO
Content Time	(0008,0033)	TM		ALWAYS	AUTO
Instance Number	(0020,0013)	IS		ALWAYS	AUTO
Referenced Request Sequence	(0040,A370)	SQ		VNAP	AUTO
>Accession Number	(0008,0050)	SH		VNAP	MWL/ USER
>Referenced Study Sequence	(0008,1110)	SQ		VNAP	MWL
>Study Instance UID	(0020,000D)	UI		VNAP	MWL/ AUTO
>Requested Procedure Description	(0032,1060)	LO		VNAP	MWL/ USER
>Requested Procedure Code Sequence	(0032,1064)	SQ		VNAP	MWL
>Requested Procedure ID	(0040,1001)	SH		VNAP	MWL/ USER
>Placer Order Number/Imaging Service Request	(0040,2016)	LO		VNAP	MWL
>Filler Order Number/Imaging Service Request	(0040,2017)	LO		VNAP	MWL
Performed Procedure Code Sequence	(0040,A372)	SQ		ALWAYS	AUTO
Current Requested Procedure Evidence Sequence	(0040,A375)	SQ		VNAP	AUTO
>Referenced Series Sequence	(0008,1115)	SQ		VNAP	AUTO
>>Referenced SOP Sequence	(0008,1199)	SQ		VNAP	AUTO
>>>Referenced SOP Class UID	(0008,1150)	UI		VNAP	AUTO
>>>Referenced SOP Instance UID	(0008,1155)	UI		VNAP	AUTO
>>Series Instance UID	(0020,000E)	UI		ALWAYS	AUTO
>Study Instance UID	(0020,000D)	UI		VNAP	MWL/ AUTO
Completion Flag	(0040,A491)	CS	COMPLETE	ALWAYS	AUTO
Verification Flag	(0040,A493)	CS	UNVERIFIED	ALWAYS	AUTO

Table 8.1-84
SOP COMMON MODULE OF CREATED ENHANCED SR SOP INSTANCES

Attribute Name	Tag	VR	Value	Presence of Value	Source
Specific Character Set	(0008,0005)	CS	Refer to Section 6	ANAP	AUTO
Instance Creation Date	(0008,0012)	DA	<yyyymmdd>	ANAP	AUTO
Instance Creation Time	(0008,0013)	TM	<hhmmss.frac>	ANAP	AUTO
SOP Class UID	(0008,0016)	UI	"1.2.840.10008.5.1.4.1.1.88.22"	ALWAYS	AUTO
SOP Instance UID	(0008,0018)	UI	Generated by device	ALWAYS	AUTO

8.1.1.16 X-Ray Radiation Dose SR Modules

Table 8.1-85
SR SERIES MODULE OF CREATED X-RAY RADIATION DOSE SR SOP INSTANCES

Attribute Name	Tag	VR	Value	Presence of Value	Source
Modality	(0008,0060)	CS	SR	ALWAYS	AUTO
Referenced Study Component Sequence	(0008,1111)	SQ		VNAP	AUTO
Series Instance UID	(0020,000E)	UI		ALWAYS	AUTO
Series Number	(0020,0011)	IS		ALWAYS	AUTO

Table 8.1-86
SR DOCUMENT GENERAL MODULE OF CREATED X-RAY RADIATION DOSE SR SOP INSTANCES

Attribute Name	Tag	VR	Value	Presence of Value	Source
Content Date	(0008,0023)	DA		ALWAYS	AUTO
Content Time	(0008,0033)	TM		ALWAYS	AUTO
Instance Number	(0020,0013)	IS		ALWAYS	AUTO
Referenced Request Sequence	(0040,A370)	SQ		VNAP	AUTO
>Accession Number	(0008,0050)	SH		VNAP	MWL/ USER
>Referenced Study Sequence	(0008,1110)	SQ		VNAP	MWL
>Study Instance UID	(0020,000D)	UI		VNAP	MWL/ AUTO
>Requested Procedure Description	(0032,1060)	LO		VNAP	MWL/ USER
>Requested Procedure Code Sequence	(0032,1064)	SQ		VNAP	MWL
>Requested Procedure ID	(0040,1001)	SH		VNAP	MWL/ USER
>Placer Order Number/Imaging Service Request	(0040,2016)	LO		VNAP	MWL
>Filler Order Number/Imaging Service Request	(0040,2017)	LO		VNAP	MWL
Performed Procedure Code Sequence	(0040,A372)	SQ		ALWAYS	AUTO
Current Requested Procedure Evidence Sequence	(0040,A375)	SQ		VNAP	AUTO

>Referenced Series Sequence	(0008,1115)	SQ		VNAP	AUTO
>>Referenced SOP Sequence	(0008,1199)	SQ		VNAP	AUTO
>>>Referenced SOP Class UID	(0008,1150)	UI		VNAP	AUTO
>>>Referenced SOP Instance UID	(0008,1155)	UI		VNAP	AUTO
>>Series Instance UID	(0020,000E)	UI		ALWAYS	AUTO
>Study Instance UID	(0020,000D)	UI		VNAP	MWL/ AUTO
Completion Flag	(0040,A491)	CS	COMPLETE	ALWAYS	AUTO
Verification Flag	(0040,A493)	CS	UNVERIFIED	ALWAYS	AUTO

Table 8.1-87

SOP COMMON MODULE OF CREATED X-RAY RADIATION DOSE SR SOP INSTANCES

Attribute Name	Tag	VR	Value	Presence of Value	Source
Specific Character Set	(0008,0005)	CS	Refer to Section 6	ANAP	AUTO
Instance Creation Date	(0008,0012)	DA	<yyyymmdd>	ANAP	AUTO
Instance Creation Time	(0008,0013)	TM	<hhmmss.frac>	ANAP	AUTO
SOP Class UID	(0008,0016)	UI	"1.2.840.10008.5.1.4.1.1.88.67"	ALWAYS	AUTO
SOP Instance UID	(0008,0018)	UI	Generated by device	ALWAYS	AUTO

8.1.1.17 Segmentation Modules

Table 8.1-88

SEGMENTATION SERIES MODULE OF CREATED SEGMENTATION SOP INSTANCES

Attribute Name	Tag	VR	Value	Presence of Value	Source
Modality	(0008,0060)	CS	SEG	ALWAYS	AUTO
Series Number	(0020,0011)	IS	Generated by device	ALWAYS	AUTO

Table 8.1-89

ENHANCED GENERAL EQUIPMENT MODULE OF CREATED SEGMENTATION SOP INSTANCES

Attribute Name	Tag	VR	Value	Presence of Value	Source
Manufacturer	(0008,0070)	LO	"TOSHIBA"	ALWAYS	AUTO
Manufacturer's Model Name	(0008,1090)	LO	Aquilion or Asteion or Alexion Activion	ALWAYS	AUTO
Device Serial Number	(0018,1000)	LO	From Configuration	VNAP	CONFIG
Software Version	(0018,1020)	LO	From Configuration	VNAP	CONFIG

Table 8.1-90
IMAGE PIXEL MODULE OF CREATED SEGMENTATION SOP INSTANCES

Attribute Name	Tag	VR	Value	Presence of Value	Source
Rows	(0028,0010)	US		ALWAYS	AUTO
Columns	(0028,0011)	US		ALWAYS	AUTO
Pixel Data	(7FE0,0010)	OB or OW		ALWAYS	AUTO

Table 8.1-91
SEGMENTATION IMAGE MODULE OF CREATED SEGMENTATION SOP INSTANCES

Attribute Name	Tag	VR	Value	Presence of Value	Source
Image Type	(0008,0008)	CS	"DERIVED≠PRIMARY"	ALWAYS	AUTO
Include 'Content Identification Macro' Table 8.1-96					
Samples per Pixel	(0028,0002)	US	1	ALWAYS	AUTO
Photometric Interpretation	(0028,0004)	CS	"MONOCHROME2"	ALWAYS	AUTO
Bits Allocated	(0028,0100)	US	1	ALWAYS	AUTO
Bits Stored	(0028,0101)	US	1	ALWAYS	AUTO
High Bit	(0028,0102)	US	0	ALWAYS	AUTO
Pixel Representation	(0028,0103)	US	0	ALWAYS	AUTO
Segmentation Type	(0062,0001)	CS	"BINARY"	ALWAYS	AUTO
Segment Sequence	(0062,0002)	SQ		ALWAYS	AUTO
>Include 'General Anatomy Mandatory Macro' Table 8.1-97					
>Segmented Property Category Code Sequence	(0062,0003)	SQ		ALWAYS	AUTO
>>Include 'Code Sequence Macro' Table 8.1-98			Baseline CID is 7150		
>Segment Number	(0062,0004)	US		ALWAYS	AUTO
>Segment Label	(0062,0005)	LO		ALWAYS	AUTO
>Segment Algorithm Type	(0062,0008)	CS	"SEMIAUTOMATIC"	ALWAYS	AUTO
>Segment Algorithm Name	(0062,0009)	LO	"TOSHIBA"	ALWAYS	AUTO
>Segmented Property Type Code Sequence	(0062,000F)	SQ		ALWAYS	AUTO
>>Include 'Code Sequence Macro' Table 8.1-98			Baseline CID is 7151		
Content Label	(0070,0080)	CS	"MODEL"	ALWAYS	AUTO
Content Description	(0070,0081)	LO		EMPTY	AUTO
Content Creator's Name	(0070,0084)	PM		EMPTY	AUTO

**Table 8.1-92
MULTI-FRAME FUNCTIONAL GROUPS MODULE OF CREATED SEGMENTATION SOP INSTANCES**

Attribute Name	Tag	VR	Value	Presence of Value	Source
Shared Functional Groups Sequence	(5200,9229)	SQ		ALWAYS	AUTO
>Include 'Pixel Measures Macro' Table 8.1-99					
>Include 'Plane Orientation Macro' Table 8.1-102					
Per-frame Functional Groups Sequence	(5200,9230)	SQ		ALWAYS	AUTO
>Include 'Frame Content Macro' Table 8.1-100					
>Include 'Plane Position Macro' Table 8.1-101					
>Include 'Segmentation Macro' Table 8.1-103					
Content Date	(0008,0023)	DA		ALWAYS	AUTO
Content Time	(0008,0033)	TM		ALWAYS	AUTO
Number of Frames	(0028,0008)	IS		ALWAYS	AUTO

**Table 8.1-93
MULTI-FRAME DIMENSION MODULE OF CREATED SEGMENTATION SOP INSTANCES**

Attribute Name	Tag	VR	Value	Presence of Value	Source
Dimension Organization Sequence	(0020,9221)	SQ		ALWAYS	AUTO
>Dimension Organization UID	(0020,9164)	UI		ALWAYS	AUTO
Dimension Index Sequence	(0020,9222)	SQ		ALWAYS	AUTO
>Dimension Index Pointer	(0020,9165)	AT		ALWAYS	AUTO
>Functional Group Pointer	(0020,9167)	AT		ALWAYS	AUTO

**Table 8.1-94
SOP COMMON MODULE OF CREATED SEGMENTATION SOP INSTANCES**

Attribute Name	Tag	VR	Value	Presence of Value	Source
Specific Character set	(0008,0005)	CS	Refer to Section 6	ANAP	CONFIG
SOP Class UID	(0008,0016)	UI	"1.2.840.10008.5.1.4.1.1.2.1"	ALWAYS	AUTO
SOP Instance UID	(0008,0018)	UI	Generated by device	ALWAYS	AUTO

**Table 8.1-95
PRIVATE APPLICATION MODULE OF CREATED ENHANCED CT IMAGE SOP INSTANCES**

Attribute Name	Tag	VR	Value	Presence of Value	Source
Private Creator Code	(7005,00xx)	LO	"TOSHIBA_MEC_CT3"	ANAP	AUTO
CT Private Data 1	(7005,xx00)	OB		ANAP	AUTO
Organ	(7005,xx0D)	CS	Typical organ in the Study.	ANAP	AUTO
File Type Remarks	(7005,xx0E)	SH	"MODEL"	ANAP	AUTO
CT Private Data 2	(7005,xx10)	OB		ANAP	AUTO
Series Comment	(7005,xx11)	LT		ANAP	AUTO
Volume UID	(7005,xx16)	UI		ANAP	AUTO
Total Frame Count in the Volume	(7005,xx17)	US		ANAP	AUTO
Frame Number	(7005,xx18)	US		ANAP	AUTO
Frame Sort Key	(7005,xx19)	UL		ANAP	AUTO
Frame Sort Order	(7005,xx1A)	US		ANAP	AUTO
Raw Data Number	(7005,xx1E)	UL		ANAP	AUTO
Volume Number	(7005,xx1F)	LO		ANAP	AUTO
Local Series Number	(7005,xx20)	UL		ANAP	AUTO
3D Object File Header	(7005,xx6f)	OB		ANAP	AUTO
3D Object Opacity Data	(7005,xx70)	OB		ANAP	AUTO
Rows of Captured Image for 3D Object	(7005,xx71)	US		ANAP	AUTO
Columns of Captured Image for 3D Object	(7005,xx72)	US		ANAP	AUTO
Allocated Bits of Captured Image for 3D Object	(7005,xx73)	US		ANAP	AUTO
Stored Bits of Captured Image for 3D Object	(7005,xx74)	US		ANAP	AUTO
High Bit of Captured Image for 3D Object	(7005,xx75)	US		ANAP	AUTO
Pixel Representation of Captured Image for 3D Object	(7005,xx76)	US		ANAP	AUTO
Captured Image for 3D Object	(7005,xx77)	OW		ANAP	AUTO
Frame Tag List for 3D Object	(7005,xx78)	AT		ANAP	AUTO

NOTE: CT Private Data 1 (7005,xx00) or CT Private Data 2 (7005,xx10) may contain some patient information.

**Table 8.1-96
CONTENT IDENTIFICATION MACRO OF CREATED SEGMENTATION SOP INSTANCES**

Attribute Name	Tag	VR	Value	Presence of Value	Source
Instance Number	(0020,0013)	IS		ALWAYS	AUTO
Content Label	(0070,0080)	CS	"MODEL"	ALWAYS	AUTO
Content Description	(0070,0081)	LO		EMPTY	AUTO
Content Creator's Name	(0070,0084)	PM		EMPTY	AUTO

**Table 8.1-97
GENERAL ANATOMY MADNATODY MACRO OF CREATED SEGMENTATION SOP INSTANCES**

Attribute Name	Tag	VR	Value	Presence of Value	Source
Anatomic Region Sequence	(0008,2218)	SQ		ALWAYS	AUTO
>Include 'Code Sequence Macro' Table 8.1-98			Baseline CID is 4031		

**Table 8.1-98
CODE SEQUENCE MACRO OF CREATED SEGMENTATION SOP INSTANCES**

Attribute Name	Tag	VR	Value	Presence of Value	Source
Code Value	(0008,0100)	SH		VNAP	USER
Coding Scheme Designator	(0008,0102)	SH		VNAP	USER
Coding Scheme Version	(0008,0103)	SH		VNAP	USER

**Table 8.1-99
PIXEL MEASURES MACRO OF CREATED SEGMENTATION SOP INSTANCES**

Attribute Name	Tag	VR	Value	Presence of Value	Source
Pixel Measures Sequence	(0028,9110)	SQ		ALWAYS	AUTO
>Pixel Spacing	(0028,0030)	DS		ALWAYS	AUTO
>Slice Thickness	(0018,0050)	DS		ALWAYS	AUTO

**Table 8.1-100
FRAME CONTENT MACRO OF CREATED SEGMENTATION SOP INSTANCES**

Attribute Name	Tag	VR	Value	Presence of Value	Source
Frame Content Sequence	(0020,9111)	SQ		ALWAYS	AUTO
>Dimension Index Values	(0020,9157)	UL		ALWAYS	AUTO

**Table 8.1-101
PLANE POSITION MACRO OF CREATED SEGMENTATION SOP INSTANCES**

Attribute Name	Tag	VR	Value	Presence of Value	Source
Plane Position Sequence	(0020,9113)	SQ		ALWAYS	AUTO
>Image Position (Patient)	(0020,0032)	DS		ALWAYS	AUTO

**Table 8.1-102
PLANE ORIENTATION MACRO OF CREATED ENHANCED CT IMAGE SOP INSTANCES**

Attribute Name	Tag	VR	Value	Presence of Value	Source
Plane Orientation Sequence	(0020,9116)	SQ		ALWAYS	AUTO
>Image Orientation (Patient)	(0020,0037)	DS		ALWAYS	AUTO

**Table 8.1-103
SEGMENTATION MACRO OF CREATED SEGMENTATION SOP INSTANCES**

Attribute Name	Tag	VR	Value	Presence of Value	Source
Segment Identification Sequence	(0062,000A)	SQ		ALWAYS	AUTO
>Referenced Segment Number	(0062,000B)	US		ALWAYS	AUTO

8.1.2 Usage of Attributes from received IOD's

No SOP Class specific fields are required.

8.1.3 Attribute Mapping

The relationships between attributes received via Modality Worklist, stored in acquired images and communicated via MPPS are summarized in Table 8.1-104.

Table 8.1-104
ATTRIBUTE MAPPING BETWEEN MODALITY WORKLIST, IMAGE AND MPPS

Modality Worklist	Image IOD	MPPS IOD
--	--	Scheduled Step Attributes Sequence
Study Instance UID	Study Instance UID	>Study Instance UID
Referenced Study Sequence	Referenced Study Sequence	>Referenced Study Sequence
Accession Number	Accession Number	>Accession Number
--	Request Attributes Sequence	--
Requested Procedure ID	>Requested Procedure ID	>Requested Procedure ID
Scheduled Procedure Step ID	>Scheduled Procedure Step ID	>Scheduled Procedure Step ID
Scheduled Procedure Step Description	>Scheduled Procedure Step Description	>Scheduled Procedure Step Description
Requested Procedure ID	Study ID	Study ID
--	Performed Procedure Step ID	Performed Procedure Step ID
--	Performed Procedure Step Description	Performed Procedure Step Description
Requested Procedure Code Sequence	Procedure Code Sequence	Procedure Code Sequence

This table shows only typical data sets.

Other data sets are also set as default settings.

All map settings, including the default setting data sets, can be customized.

8.1.4 Coerced/Modified Fields

Not applicable to this product

8.1.5 STRUCTURED REPORT DOCUMENT INFORMATIONS

8.1.5.1 Calcium Scoring Report

8.1.5.1.1 Template Structure

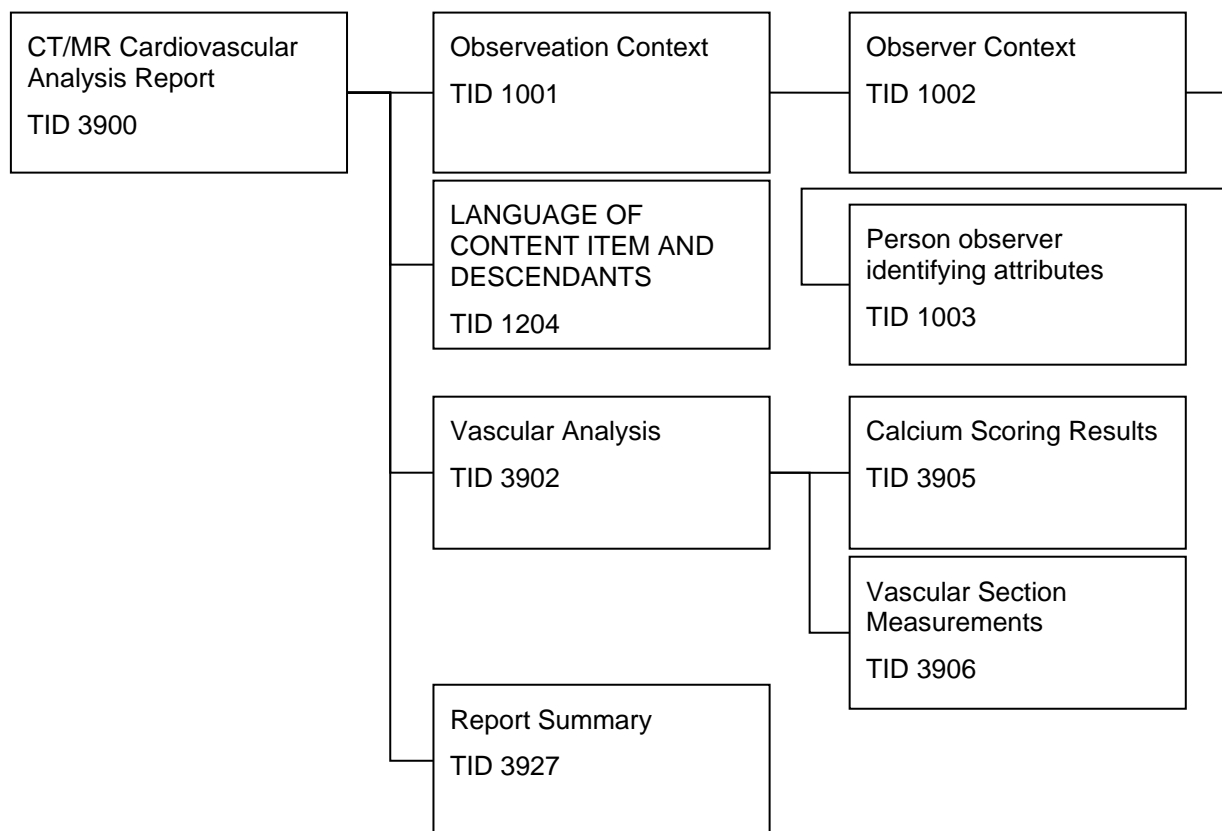

8.1.5.1.2 TID 3900 CT/MR Cardiovascular Analysis Report

Table 8.1-105

CT/MR Cardiovascular Analysis Report

NL	Rel with Parent	Concept Name	VM	Presence of Value	Value
		EV (122600, DCM, "Cardiovascular Analysis Report")	1	ALWAYS	
>	HAS CONCEPT MOD	EV(121058, DCM, "Procedure Reported")	1	ALWAYS	SRT,P5-0807F,"cardiovascular CT"
>	HAS CONCEPT MOD	TID 1204 LANGUAGE OF CONTENT ITEM AND DESCENDANTS	1	ALWAYS	
>	HAS OBS CONTEXT	TID 1001 OBSERVATION CONTEXT	1	ALWAYS	
>	CONTAINS	TID 3902 Vascular Analysis	1	ALWAYS	

8.1.5.1.3 TID 1204 LANGUAGE OF CONTENT ITEM AND DESCENDANTS

Table 8.1-106
Language of Content Item and Descendants

NL	Rel with Parent	Concept Name	VM	Presence of Value	Value
	HAS CONCEPT MOD	(121049,DCM,"Language of Content Item and Descendants")	1	ALWAYS	RFC3066 ,"en", "English" or RFC3066 ,"ja", "Japanese"
>	HAS CONCEPT MOD	(121046,DCM,"Country of Language")	1	ALWAYS	ISO3166_1,US,"UNITED STATES" or ISO3166_1,JP,"JAPAN"

8.1.5.1.4 TID 1001 OBSERVATION CONTEXT

Table 8.1-107
OBSERVATION CONTEXT

NL	Rel with Parent	Concept Name	VM	Presence of Value	Value
	HAS CONCEPT MOD	DTID (1002) "Observer Context"	1	ALWAYS	

8.1.5.1.5 TID 1002 OBSERVER CONTEXT

Table 8.1-108
OBSERVER CONTEXT

NL	Rel with Parent	Concept Name	VM	Presence of Value	Value
	HAS OBS CONTEXT	DTID (1003) Person observer identifying attributes	1	USER	

8.1.5.1.6 TID 1003 PERSON OBSERVER IDENTIFYING ATTRIBUTES

Table 8.1-109
PERSON OBSERVER IDENTIFYING ATTRIBUTES

NL	Rel with Parent	Concept Name	VM	Presence of Value	Value
		EV (121008,DCM, "Person Observer Name")	1	USER	

8.1.5.1.7 TID 3902 Vascular Analysis

Table 8.1-110
Vascular Analysis

NL	Rel with Parent	Concept Name	VM	Presence of Value	Value
		EV (121070, DCM, "Findings")	1	ALWAYS	
>	HAS CONCEPT MOD	EV(111004, DCM, "Analysis Performed")	1	ALWAYS	EV(122605, DCM, "Vascular Morphological Analysis")
>	CONTAINS	TID 3905 Calcium Scoring Results	1	ALWAYS	
>	CONTAINS	TID 3906 Vascular Section Measurements	1-n		

8.1.5.1.8 TID 3905 Calcium Scoring Results

Table 8.1-111
Calcium Scoring Results

NL	Rel with Parent	Concept Name	VM	Presence of Value	Value
		EV (121070, DCM, "Findings")	1	ALWAYS	
>	CONTAINS	EV(111004, DCM, "Analysis Performed")	1	ALWAYS	EV(122603, DCM, "Calcium Scoring Analysis")
>	CONTAINS	EV(122657, DCM, "Agatston Score Threshold")	1	ALWAYS	AUTO
>	CONTAINS	EV(112058, DCM, "Calcium Score")	1	ALWAYS	AUTO
>>	HAS CONCEPT MOD	EV(112055, DCM, "Agatston Scoring Method")	1	ALWAYS	AUTO
>>	HAS PROPERTIES	EV(R-00317,SRT, "Mean Value of population")	1	ALWAYS	AUTO
>>	HAS PROPERTIES	EV(121414,DCM, " Standard deviation of population")	1	ALWAYS	AUTO
>	CONTAINS	EV(122660, DCM, "Calcium Volume")	1	ALWAYS	AUTO
>	CONTAINS	EV(F-02A3B, SRT, "Number of Lesions")	1	ALWAYS	AUTO
>	CONTAINS	EV(99TOST0001-0001, 99TOSHIBA-TMSC,"Pixel Threshold ")	1		AUTO

8.1.5.1.9 TID 3906 Vascular Section Measurements

Table 8.1-112
Vascular Section Measurements

NL	Rel with Parent	Concept Name	VM	Presence of Value	Value
	CONTAINS	EV (T-43000, SRT," Coronary Artery Structure ")	1-n	ALWAYS	
>	CONTAINS	EV (121070, DCM, "Findings")	1	ALWAYS	
>>	HAS CONCEPT MOD	EV(G-C0E3, SRT, "Finding Site")	1	ALWAYS	AUTO CID 3014 Coronary Artery Segments CID 3015 Coronary Arteries
>>	CONTAINS	TID 3905 Calcium Scoring Results	1	ALWAYS	

8.1.5.2 CT Radiation Dose Report

8.1.5.2.1 Template Structure

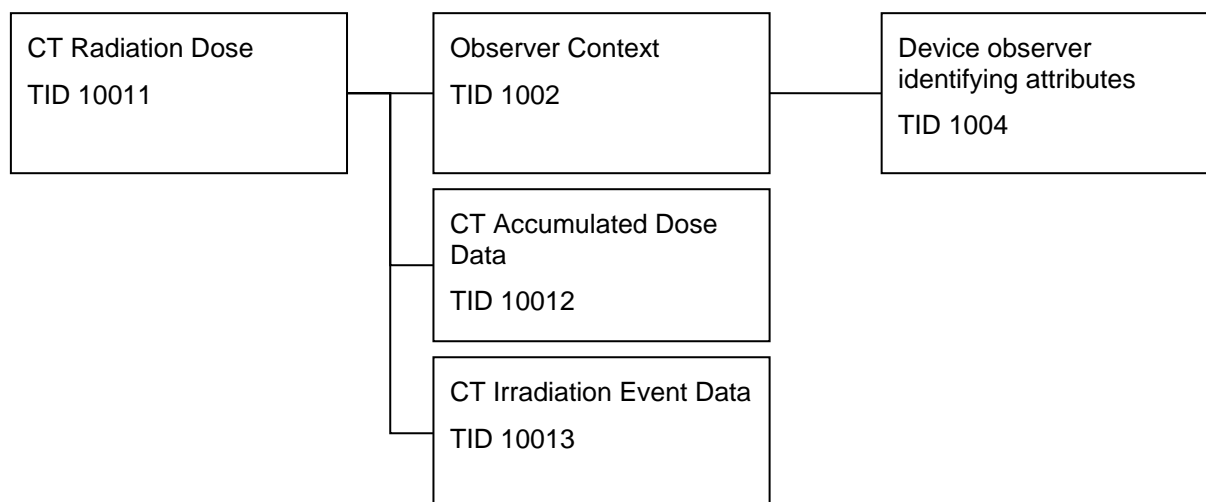

8.1.5.2.2 TID 10011 CT RADIATION DOSE

Table 8.1-113
CT RADIATION DOSE

NL	Rel with Parent	Concept Name	VM	Presence of Value	Value
		EV (113701, DCM, "Xray Radiation Dose Report")	1	ALWAYS	AUTO
>	HAS CONCEPT MOD	EV (121058, DCM, "Procedure reported")	1	ALWAYS	EV (P5-08000,SRT,"Computed Tomography Xray")
>>	HAS CONCEPT MOD	EV (G-C0E8, SRT, "Has Intent")	1	ALWAYS	EV (R-408C3,SRT,"Diagnostic Intent")
>		TID 1002 OBSERVER CONTEXT	1	ALWAYS	
>	HAS OBS CONTEXT	EV (113809, DCM, "Start of X-ray Irradiation")	1	ALWAYS	AUTO
>	HAS OBS CONTEXT	EV (113810, DCM, "End of X-ray Irradiation")	1	ALWAYS	AUTO
>	HAS OBS CONTEXT	EV (113705, DCM, "Scope of Accumulation")	1	ALWAYS	EV (113014,DCM,"Study")
>>	HAS PROPERTIES	EV (110180, DCM, "Study Instance UID")	1	ALWAYS	AUTO
>	CONTAINS	TID 10012 CT ACCUMULATED DOSE DATA	1	ALWAYS	
>	CONTAINS	TID 10013 CT IRRADIATION EVENT DATA	1-n	ALWAYS	

>	CONTAINS	EV (113854, DCM, "Source of Dose Information")	1	ALWAYS	EV (113856, DCM, "Automated Data Collection")
>	CONTAINS	EV (99TOST000A-0001, 99TOSHIBA-TMSC, "Patient Body Parameters")	1	ALWAYS	
>>	CONTAINS	EV (99TOST000A-0002, 99TOSHIBA-TMSC, "Mean Body Thickness")	1	ANAP	AUTO
>>	CONTAINS	EV (99TOST000A-0003, 99TOSHIBA-TMSC, "Maximum Body Thickness")	1	ANAP	AUTO
>>	CONTAINS	EV (99TOST000A-0004, 99TOSHIBA-TMSC, "Minimum Body Thickness")	1	ANAP	AUTO
>>	CONTAINS	EV (99TOST000A-0005, 99TOSHIBA-TMSC, "Total Number of Images")	1	ALWAYS	AUTO
>>	CONTAINS	EV (99TOST000A-0006, 99TOSHIBA-TMSC, "Contrast Enhance")	1	ANAP	AUTO

8.1.5.2.3 TID 1002 OBSERVER CONTEXT

Table 8.1-114
OBSERVER CONTEXT

NL	Rel with Parent	Concept Name	VM	Presence of Value	Value
	HAS OBS CONTEXT	EV (121005, DCM, "Observer Type")	1	ALWAYS	121007, DCM, "Device"
		TID (1004) Device observer identifying attributes	1	ALWAYS	

8.1.5.2.4 TID 1004 DEVICE OBSERVER IDENTIFYING ATTRIBUTES

Table 8.1-115
DEVICE OBSERVER IDENTIFYING ATTRIBUTES

NL	Rel with Parent	Concept Name	VM	Presence of Value	Value
		EV (121012, DCM, "Device Observer UID")	1	ALWAYS	

8.1.5.2.5 TID 10012 CT ACCUMULATED DOSE DATA

Table 8.1-116
CT ACCUMULATED DOSE DATA

NL	Rel with Parent	Concept Name	VM	Presence of Value	Value
	CONTAINS	EV (113811, DCM, "CT Accumulated Dose Data")	1	ALWAYS	AUTO
>	CONTAINS	EV (113812, DCM, "Total Number of Irradiation Events")	1	ALWAYS	AUTO
>	CONTAINS	EV (113813, DCM, "CT Dose Length Product Total")	1	ALWAYS	AUTO

8.1.5.2.6 TID 10013 CT IRRADIATION EVENT DATA

Table 8.1-117
CT IRRADIATION EVENT DATA

NL	Rel with Parent	Concept Name	VM	Presence of Value	Value
		EV (113819, DCM, "CT Acquisition")	1	ALWAYS	AUTO
>	CONTAINS	EV (123014 , DCM, "Target Region")	1	ALWAYS	AUTO CID 4030 CT and MR Anatomy Imaged
>	CONTAINS	EV (113820, DCM, "CT Acquisition Type")	1	ALWAYS	AUTO CID 10013 CT Acquisition Types
>	CONTAINS	EV(G-C23C, SRT, "Procedure Context")	1	ALWAYS	AUTO CID 10014 Contrast Imaging Technique
>	CONTAINS	EV (113769, DCM, "Irradiation Event UID")	1	ALWAYS	AUTO
>	CONTAINS	EV (113822, DCM, "CT Acquisition Parameters")	1	ALWAYS	AUTO
>>	CONTAINS	EV (113824, DCM, "Exposure Time")	1	ALWAYS	AUTO
>>	CONTAINS	EV (113825, DCM, "Scanning Length")	1	ALWAYS	AUTO
>>	CONTAINS	EV (113826, DCM, "Nominal Single Collimation Width")	1	ALWAYS	AUTO
>>	CONTAINS	EV (113827, DCM, "Nominal Total Collimation Width")	1	ALWAYS	AUTO
>>	CONTAINS	EV (113828, DCM, "Pitch Factor")	1	ANAP	AUTO
>>	CONTAINS	EV (113823, DCM, "Number of X-ray Sources")	1	ALWAYS	AUTO 1 or 2
>>	CONTAINS	EV (113831, DCM, "CT X-ray Source Parameters")	1 or 2	ALWAYS	AUTO
>> >	CONTAINS	EV (113832, DCM, "Identification Number of the X-ray Source")	1	ALWAYS	AUTO
>> >	CONTAINS	EV (113733, DCM, "KVP")	1	ALWAYS	AUTO
>> >	CONTAINS	EV (113833, DCM, "Maximum X-ray Tube Current")	1	ALWAYS	AUTO
>> >	CONTAINS	EV (113734, DCM, "X-Ray TubeCurrent")	1	ALWAYS	AUTO
>> >	CONTAINS	EV (113834, DCM, "Exposure Time per Rotation")	1	ANAP	AUTO
>	CONTAINS	EV (113829, DCM, "CT Dose")	1	ANAP	AUTO
>>	CONTAINS	EV (113830, DCM, "Mean CTDIvol ")	1	ALWAYS	AUTO

>>	CONTAINS	EV (113835, DCM, "CTDIw Phantom Type")	1	ALWAYS	AUTO EV (113690,DCM,"IEC Head Dosimetry Phantom") Or EV (113691, DCM,"IEC Body Dosimetry Phantom")
>>	CONTAINS	EV (113838, DCM,"DLP")	1	ALWAYS	AUTO
>	CONTAINS	EV (113842, DCM, "X-ray Modulation Type")	1	ALWAYS	AUTO
>	CONTAINS	EV (99TOST000B-0001, 99TOSHIBA-TMSC,"Dose Reduce Parameters")	1	ANAP	AUTO
>>	CONTAINS	EV (99TOST000B-0002, 99TOSHIBA-TMSC,"Modulation")	1	ANAP	AUTO
>>	CONTAINS	EV (121414, DCM, "Standard deviation of population")	1	ANAP	AUTO
>>	CONTAINS	EV (99TOST000B-0003, 99TOSHIBA-TMSC,"Boost")	1	ANAP	AUTO
>>	CONTAINS	EV (99TOST000B-0004, 99TOSHIBA-TMSC,"QDS")	1	ANAP	AUTO
>>	CONTAINS	EV (99TOST000B-0005, 99TOSHIBA-TMSC,"Dose Reduce Mode")	1	ANAP	AUTO
>>	CONTAINS	EV (99TOST000B-0006, 99TOSHIBA-TMSC,"Dose Reduce Ratio")	1	ANAP	AUTO

8.2 DATA DICTIONARY OF PRIVATE ATTRIBUTES

This product reserves private attribute values in the group 7005 and 7007.

The private attributes added to created SOP instances or directory records are listed in the following table;

Table 8.2-1
DATA DICTIONARY OF PRIVATE ATTRIBUTES

Tag	Attribute Name	VR	VM
(7005,00xx)	Private Creator Code	LO	1
(7005,xx00)	CT Private Data 1	OB	1-n
(7005,xx03)	Cardiac R-R Mean Time	SH	1
(7005,xx04)	Cardiac Reconstruction Gating Phase in Percent	SH	1
(7005,xx05)	Cardiac Reconstruction Gating Phase in ms	SH	1
(7005,xx06)	Cardiac Reconstruction Mode	SH	1
(7005,xx07)	Reconstruction Center	DS	1-n
(7005,xx08)	Detector Slice Thickness in mm	DS	1
(7005,xx09)	Number of Detector rows to Reconstruct	LO	1
(7005,xx0A)	Table Speed in mm/rot	DS	1
(7005,xx0B)	Filter	SH	1
(7005,xx0C)	Reconstruction Correction Type	SH	1
(7005,xx0D)	Organ	CS	1
(7005,xx0E)	File Type Remarks	SH	1
(7005,xx0F)	Direction	SH	1
(7005,xx10)	CT Private Data 2	OB	1-n
(7005,xx11)	Series Comment	LT	1
(7005,xx12)	Position	SH	1
(7005,xx13)	Expert Plan No.	US	1
(7005,xx14)	Reconstruction ROI No.	US	1
(7005,xx15)	Special Helical ACQ No.	US	1
(7005,xx16)	Volume UID	UI	1
(7005,xx17)	Total Frame Count in the Volume	US	1
(7005,xx18)	Frame No.	US	1
(7005,xx19)	Frame Sort Key	UL	1
(7005,xx1A)	Frame Sort Order	US	1
(7005,xx1B)	Convolution Kernel	SH	1
(7005,xx1C)	Contrast/Bolus Agent	LO	1
(7005,xx1D)	Reconstruction Number	UL	1
(7005,xx1E)	Raw Data Number	UL	1
(7005,xx1F)	Volume Number	LO	1
(7005,xx20)	Local Series Number	UL	1
(7005,xx21)	Decrease in Artifact Filter	LO	1
(7005,xx22)	Reconstruction Interval	DS	1
(7005,xx23)	Pitch Factor	DS	1
(7005,xx24)	The Acquisition Date of NRA	DA	1
(7005,xx25)	Large Data File Attribute	UL	1

(7005,xx26)	Large Data File Name	CS	1-8
(7005,xx28)	Enhanced CT Private Sequence	SQ	1
(7005,xx29)	Frame UID	UI	1
(7005,xx30)	Main Modality in Study	CS	1
(7005,xx35)	Scan Range	DS	2
(7005,xx36)	CT Private Data 3	OB	1-n
(7005,xx37)	Total Frames	IS	1
(7005,xx38)	Start Frame	IS	1
(7005,xx39)	End Frame	IS	1
(7005,xx40)	DLP(Dose Length Product)	FD	1
(7005,xx41)	Raw Slice Information	SH	1
(7005,xx42)	Local Frame No	US	1
(7005,xx43)	Volume Vector	DS	3
(7005,xx44)	Volume Type	US	1
(7005,xx45)	Relative Table Position of 4D Volume	DS	1
(7005,xx46)	Absolute Table Position of 4D Volume	DS	1
(7005,xx47)	Slice Pitch of 4D Volume	DS	1
(7005,xx48)	Respiratory Gating Inf.	LO	1
(7005,xx49)	Respiration Phase	SH	1
(7005,xx61)	Synchronized Signal Information	LO	1
(7005,xx62)	Total Raw Data Size	DS	1
(7005,xx63)	CTDIw	FD	1
(7005,xx67)	Volume UID of 4D-Volume	UI	1
(7005,xx68)	Total Frame Count in 4D-Volume	US	1
(7005,xx69)	Frame Number in 4D-Volume	US	1
(7005,xx6a)	Image Position of 4D-Volume Top	DS	3
(7005,xx6b)	Image Position of 4D-Volume Top (Equipment)	DS	3
(7005,xx6c)	SOP Instance UID of 4D-Volume	UI	1
(7005,xx6d)	Series Instance UID of 4D-Volume	UI	1
(7005,xx6e)	Stitching	SH	1
(7005,xx6f)	3D Object File Header	OB	1-n
(7005,xx70)	3D Object Opacity Data	OB	1-n
(7005,xx71)	Rows of Captured Image for 3D Object	US	1
(7005,xx72)	Columns of Captured Image for 3D Object	US	1
(7005,xx73)	Allocated Bits of Captured Image for 3D Object	US	1
(7005,xx74)	Stored Bits of Captured Image for 3D Object	US	1
(7005,xx75)	High Bit of Captured Image for 3D Object	US	1
(7005,xx76)	Pixel Representation of Captured Image for 3D Object	US	1
(7005,xx77)	Captured Image for 3D Object	OW	1-n
(7005,xx78)	Frame Tag List for 3D Object	AT	1-n
(7005,xx79)	Injector Elapsed Time	SH	1
(7005,xx7a)	Series Instance UID of Shuttle Helical Volume	UI	1
(7005,xx7b)	Basis Material of Raw Data DE	LO	1

(7005,xxF1)	Protect Mark for Image, Curve or Private Record	CS	1
(7005,xxF2)	Protect Mark for Series Record	CS	1
(7005,xxF3)	Protect Mark for Study Record	CS	1
(7007,00xx)	Private Creator Code	LO	1

NOTE: CT Private Data 1 (7005,xx00) or CT Private Data 2 (7005,xx10) may contain some patient information.

8.3 CONTROLLED TERMINOLOGY AND TEMPLATES

Not applicable to this product

8.4 GRAYSCALE IMAGE CONSISTENCY

Not applicable to this product

8.5 STANDARD EXTENDED/SPECIALIZED/PRIVATE SOP CLASSES

8.5.1 Standard Extended SOP Class - CT Image Storage

The Storage SCU AE and the Offline-Media AE are making the following extensions to DICOM SOP Classes:

SOP Class	:	CT Image Storage
Attribute	:	Filter Material (0018,7050)
		Acquisition Type (0018,9302)
		Tube Angle (0018,9303)
		Table Position (0018,9327)
		Fluoroscopy Flag (0018,9334)
		Stack ID (0020,9056)
		In-Stack Position Number (0020,9057)
		Temporal Position Index (0020,9128)
		Respiratory Interval Time (0020,9254)

8.5.2 Private SOP Class - Toshiba CT Non-Image Storage

Table 8.5-1 specifies the attributes of a Toshiba CT Non-Image exported or added by the DED-CT-CD AP or the DED-DVD-RAM AP.

**Table 8.5-1
IOD OF CREATED TOSHIBA CT NON-IMAGE SOP INSTANCES**

IE	Module	Reference	Presence of Module
Patient	Patient	Table 8.1-11	ALWAYS
Study	General Study	Table 8.1-12	ALWAYS
	Patient Study	Table 8.1-13	Only if "Patient's Age" is present
Series	General Series	Table 8.1-14	ALWAYS
Equipment	General Equipment	Table 8.1-16	ALWAYS
Private	Toshiba CT Non-Image	Table 8.5-2	ALWAYS
	SOP Common	Table 8.5-3	ALWAYS
	Private Application	Table 8.5-4	Only if private data are present

**Table 8.5-2
TOSHIBA CT NON-IMAGE MODULE OF CREATED TOSHIBA CT NON-IMAGE SOP INSTANCES**

Attribute Name	Tag	VR	Value	Presence of Value	Source
Toshiba CT Non-Image Data	(7FE0,0010)	OB		ALWAYS	AUTO

**Table 8.5-3
SOP COMMON MODULE OF CREATED TOSHIBA CT NON-IMAGE SOP INSTANCES**

Attribute Name	Tag	VR	Value	Presence of Value	Source
Specific Character set	(0008,0005)	CS	Refer to Section 6	ANAP	CONFIG
SOP Class UID	(0008,0016)	UI	"1.2.392.200036.9116.2.6.1.1"	ALWAYS	AUTO
SOP Instance UID	(0008,0018)	UI	Generated by device	ALWAYS	AUTO

**Table 8.5-4
PRIVATE APPLICATION MODULE OF CREATED TOSHIBA CT NON-IMAGE SOP INSTANCES**

Attribute Name	Tag	VR	Value	Presence of Value	Source
Private Creator Code	(7005,00xx)	LO	"TOSHIBA_MEC_CT3"	ANAP	AUTO
CT Private Data 1	(7005,xx00)	OB		ANAP	AUTO
Cardiac R-R Mean Time	(7005,xx03)	SH	Ex.) "9999.9ms"	ANAP	AUTO
Cardiac Reconstruction Getting Phase in Percent	(7005,xx04)	SH	Ex.) "99%"	ANAP	AUTO
Cardiac Reconstruction Getting Phase in ms	(7005,xx05)	SH	Ex.) "999ms"	ANAP	AUTO
Cardiac Reconstruction Mode	(7005,xx06)	SH	"HALF", "SEGMENT"	ANAP	AUTO
Reconstruction Center	(7005,xx07)	DS		ANAP	AUTO
Detector Slice Thickness in mm	(7005,xx08)	DS	Ex.) "+9999.99"	ANAP	AUTO
Number of Detector rows to Reconstruct	(7005,xx09)	LO	Ex.) "0000111111110000" or "FFFF" 8 detectors were used to reconstruct image	ANAP	AUTO
Table Speed in mm/rot	(7005,xx0A)	DS	Ex.) "+99.99"	ANAP	AUTO
Filter	(7005,xx0B)	SH	Ex.) "ORG "	ANAP	AUTO
Reconstruction Correction Type	(7005,xx0C)	SH		ANAP	AUTO
Organ	(7005,xx0D)	CS	Typical organ in the Study.	ANAP	AUTO
File Type Remarks	(7005,xx0E)	SH	"CBPINF", etc.	ANAP	AUTO
Direction	(7005,xx0F)	SH	"HF", "FF", etc.	ANAP	AUTO
CT Private Data 2	(7005,xx10)	OB		ANAP	AUTO
Series Comment	(7005,xx11)	LT		ANAP	AUTO
Position	(7005,xx12)	SH	"SU", "PR", etc.	ANAP	AUTO
Expert Plan No.	(7005,xx13)	US		ANAP	AUTO
Reconstruction ROI No.	(7005,xx14)	US		ANAP	AUTO
Special Helical ACQ No.	(7005,xx15)	US		ANAP	AUTO
Volume UID	(7005,xx16)	UI		ANAP	AUTO
Total Frame Count in the Volume	(7005,xx17)	US		ANAP	AUTO
Frame No.	(7005,xx18)	US		ANAP	AUTO
Frame Sort Key	(7005,xx19)	UL		ANAP	AUTO
Frame Sort Order	(7005,xx1A)	US		ANAP	AUTO
Convolution Kernel for Series Record	(7005,xx1B)	SH	Ex.) "FL99" or "FC99"	ANAP	AUTO
Contrast/Bolus Agent for Series Record	(7005,xx1C)	LO		ANAP	AUTO
Reconstruction Number	(7005,xx1D)	UL		ANAP	AUTO
Raw Data Number	(7005,xx1E)	UL		ANAP	AUTO
Volume Number	(7005,xx1F)	LO		ANAP	AUTO

Local Series Number	(7005,xx20)	UL		ANAP	AUTO
Decrease in Artifact Filter	(7005,xx21)	LO	Ex.) "RASP", "BOOST"	ANAP	AUTO
Reconstruction Interval	(7005,xx22)	DS	Ex.) "7.00"	ANAP	AUTO
Pitch Factor	(7005,xx23)	DS	Ex.) "0.641"	ANAP	AUTO
The Acquisition Date of NRA	(7005,xx24)	DA	Ex.) "20051121"	ANAP	AUTO
Large Data File Attribute	(7005,xx25)	UL		ANAP	AUTO
Large Data File Name	(7005,xx26)	CS		ANAP	AUTO
Main Modality in Study	(7005,xx30)	CS	Ex.) "CT"	ANAP	AUTO
Scan Range	(7005,xx35)	DS		ANAP	AUTO
CT Private Data 3	(7005,xx36)	OB		ANAP	AUTO
Total Frames	(7005,xx37)	IS		ANAP	AUTO
Start Frame	(7005,xx38)	IS		ANAP	AUTO
End Frame	(7005,xx39)	IS		ANAP	AUTO
DLP (Dose Length Product)	(7005,xx40)	FD		ANAP	AUTO
Row Slice Information	(7005,xx41)	SH	Ex.) "0.5x64", "10.0x2", "1.0x1"	ANAP	AUTO

NOTE: CT Private Data 1 (7005,xx00) or CT Private Data 2 (7005,xx10) may contain some patient information.

8.6 PRIVATE TRANSFER SYNTAXES

Not applicable to this product