

TOSHIBA

DICOM CONFORMANCE STATEMENT
FOR
TOSHIBA DIGITAL RADIOGRAPHY SYSTEM
Infinix Celeve-i series / Infinix-i series
Model DFP-8000 series
V4.40

TOSHIBA MEDICAL SYSTEMS CORPORATION

© TOSHIBA MEDICAL SYSTEMS CORPORATION 2011
ALL RIGHTS RESERVED

Trademarks

Infinix Celeve is a trademark of Toshiba Medical Systems Corporation.
This document may include trademarks or registered trademarks of other companies.
Note that the TM mark and the ® mark are not used in this manual.

IMPORTANT!

- (1) No part of this document may be copied or reprinted, in whole or in part, without written permission.
- (2) The contents of this document are subject to change without prior notice and without our legal obligation.

*

1. CONFORMANCE STATEMENT OVERVIEW

Table 1-1 provides an overview of the network services supported by DFP-8000 series. This corresponds since software version V4.40.

**Table 1-1
NETWORK SERVICES**

SOP Classes	User of Service (SCU)	Provider of Service (SCP)
Transfer		
XA Image Storage	Yes ^{*1}	Yes
X-Ray Radiation Dose SR	Yes ^{*2}	No
Storage Commitment		
Storage Commitment Push Model	Yes ^{*1}	No
Query/Retrieve		
Patient Root Q/R Information Model – Find	Yes ^{*1}	No
Patient Root Q/R Information Model – Move	Yes ^{*1}	No
Workflow Management		
Modality Worklist Information Model – Find	Yes ^{*1}	No
Modality Performed Procedure Step	Yes ^{*1}	No
Print Management		
Basic Grayscale Print Management	Yes	No

^{*1}:Option

^{*2}:Option since software version V4.25

Table 1-2 provides an overview of the Media Storage Application Profiles supported by Infinix Celeve.

**Table 1-2
MEDIA SERVICES**

Media Storage Application Profile	Write Files (FSC or FSU)	Read Files (FSR)
Compact Disk – Recordable		
XA Image CD-R	Yes	Yes
General Purpose CD-R	Yes	Yes
DVD		
XA Image DVD-R	Yes	Yes
General Purpose DVD-R	Yes	Yes

**Table 1-3
SUPPORTED IODS, SOP CLASSES AND TRANSFER SYNTAXES**

Information Object Definition	SOP Class UID	Transfer Syntax	Transfer Syntax UID
Media Storage Directory Storage	1.2.840.10008.1.3.10	Explicit VR Little Endian Uncompressed	1.2.840.10008.1.2.1
XA Image Storage	1.2.840.10008.5.1.4.1.1.12.1	Explicit VR Little Endian Uncompressed	1.2.840.10008.1.2.1
XA Image Storage	1.2.840.10008.5.1.4.1.1.12.1	Jpeg Lossless	1.2.840.10008.1.2.4.70
X-Ray Radiation Dose SR	1.2.840.10008.5.1.4.1.1.88.67	Explicit VR Little Endian Uncompressed	1.2.840.10008.1.2.1

*

2. TABLE OF CONTENTS

1.	CONFORMANCE STATEMENT OVERVIEW	i
2.	TABLE OF CONTENTS	a
3.	INTRODUCTION	1
3.1	REVISION HISTORY	1
3.2	AUDIENCE	1
3.3	REMARKS	1
3.4	DEFINITIONS, TERMS AND ABBREVIATIONS	2
3.5	REFERENCES.....	2
4.	NETWORKING	3
4.1	IMPLEMENTATION MODEL.....	3
4.1.1	Application Data Flow	3
4.1.2	Functional Definition of AEs.....	5
4.1.3	Sequencing of Real-World Activities.....	6
4.2	AE SPECIFICATIONS	8
4.2.1	Verification SCU AE Specification	8
4.2.2	Verification SCP AE Specification	11
4.2.3	Storage SCU AE Specification	14
4.2.4	Storage Commitment SCU AE Specification	18
4.2.5	MWM SCU AE Specification.....	25
4.2.6	MPPS SCU AE Specification	33
4.2.7	Q/R SCU AE Specification.....	40
4.2.8	Storage SCP AE Specification.....	48
4.2.9	Print SCU AE Specification.....	52
4.3	NETWORK INTERFACES	63
4.3.1	Physical Network Interface	63
4.3.2	Additional Protocols	63
4.4	CONFIGURATION.....	63
4.4.1	AE Title/Presentation Address Mapping.....	63
4.4.2	Parameters	64
5.	MEDIA INTERCHANGE	68
5.1	IMPLEMENTATION MODEL.....	68
5.1.1	Application Data Flow	68
5.1.2	Functional Definition of AEs.....	68
5.1.3	Sequencing of Real-World Activities.....	69
5.1.4	File Meta Information for Implementation Class and Version.....	69
5.2	AE SPECIFICATIONS	70
5.2.1	Offline-Media AE Specification	70
5.3	MEDIA CONFIGURATION	71
6.	SUPPORT OF CHARACTER SETS.....	72
7.	SECURTIY.....	73
8.	ANNEXES	74

8.1	IOD CONTENTS	74
8.1.1	Created SOP Instances	74
8.1.2	Usage of Attributes from received IOD's	107
8.1.3	Attribute Mapping	107
8.1.4	Coerced/Modified Fields	109
8.2	DATA DICTIONARY OF PRIVATE ATTRIBUTES	109
8.3	CONTROLLED TERMINOLOGY AND TEMPLATES	112
8.4	GRAYSCALE IMAGE CONSISTENCY	112
8.5	STANDARD EXTENDED/SPECIALIZED/PRIVATE SOP CLASSES	112
8.6	PRIVATE TRANSFER SYNTAXES	112

3. INTRODUCTION

3.1 REVISION HISTORY

Document Version	Date of Issue	Author	Description
L	October 25, 2012	TMSC	Add software version in front cover Update "Presence of Value" of Distance Source to Patient (0018,1111)

3.2 AUDIENCE

This document is intended for hospital staff, health system integrators, software designers or implementers. It is assumed that the reader has a working understanding of DICOM.

3.3 REMARKS

DICOM, by itself, does not guarantee interoperability. However, the Conformance Statement facilitates a first-level validation for interoperability between different applications supporting the same DICOM functionality.

This Conformance Statement is not intended to replace validation with other DICOM equipment to ensure proper exchange of information intended.

The scope of this Conformance Statement is to facilitate communication with Toshiba Medical Systems and other vendors' Medical equipment. The Conformance Statement should be read and understood in conjunction with the DICOM Standard [DICOM]. However, by itself it is not guaranteed to ensure the desired interoperability and a successful interconnectivity.

The user should be aware of the following important issues:

- The comparison of different conformance statements is the first step towards assessing interconnectivity between Toshiba Medical Systems and non- Toshiba Medical Systems equipment.
- Test procedures should be defined to validate the desired level of connectivity.
- The DICOM standard will evolve to meet the users' future requirements. Toshiba Medical Systems is actively involved in developing the standard further and therefore reserves the right to make changes to its products or to discontinue its delivery.

3.4 DEFINITIONS, TERMS AND ABBREVIATIONS

Definitions, terms and abbreviations used in this document are defined within the different parts of the DICOM standard.

Abbreviations and terms are as follows:

AE	Application Entity
AET	Application Entity Title
ASCE	Association Control Service Element
CD-R	Compact Disk Recordable
DIMSE	DICOM Message Service Element
DVD	A trademark of the DVD forum that is not an abbreviation
DVD-R	DVD Recordable
FSC	File-Set Creator
FSU	File-Set Updater
FSR	File-Set Reader
IE	Information Entity
IOD	Information Object Definition
MPPS	Modality Performed Procedure Step
MSPS	Modality Scheduled Procedure Step
MWM	Modality Worklist Management
R	Required Key Attribute
O	Optional Key Attribute
PDU	Protocol Data Unit
SCU	Service Class User (DICOM client)
SCP	Service Class Provider (DICOM server)
SOP	Service-Object Pair
U	Unique Key Attribute
UID	Unique Identifier

3.5 REFERENCES

[DICOM] Digital Imaging and Communications in Medicine (DICOM), NEMA PS 3.1-3.16, 2009

4. NETWORKING

4.1 IMPLEMENTATION MODEL

4.1.1 Application Data Flow

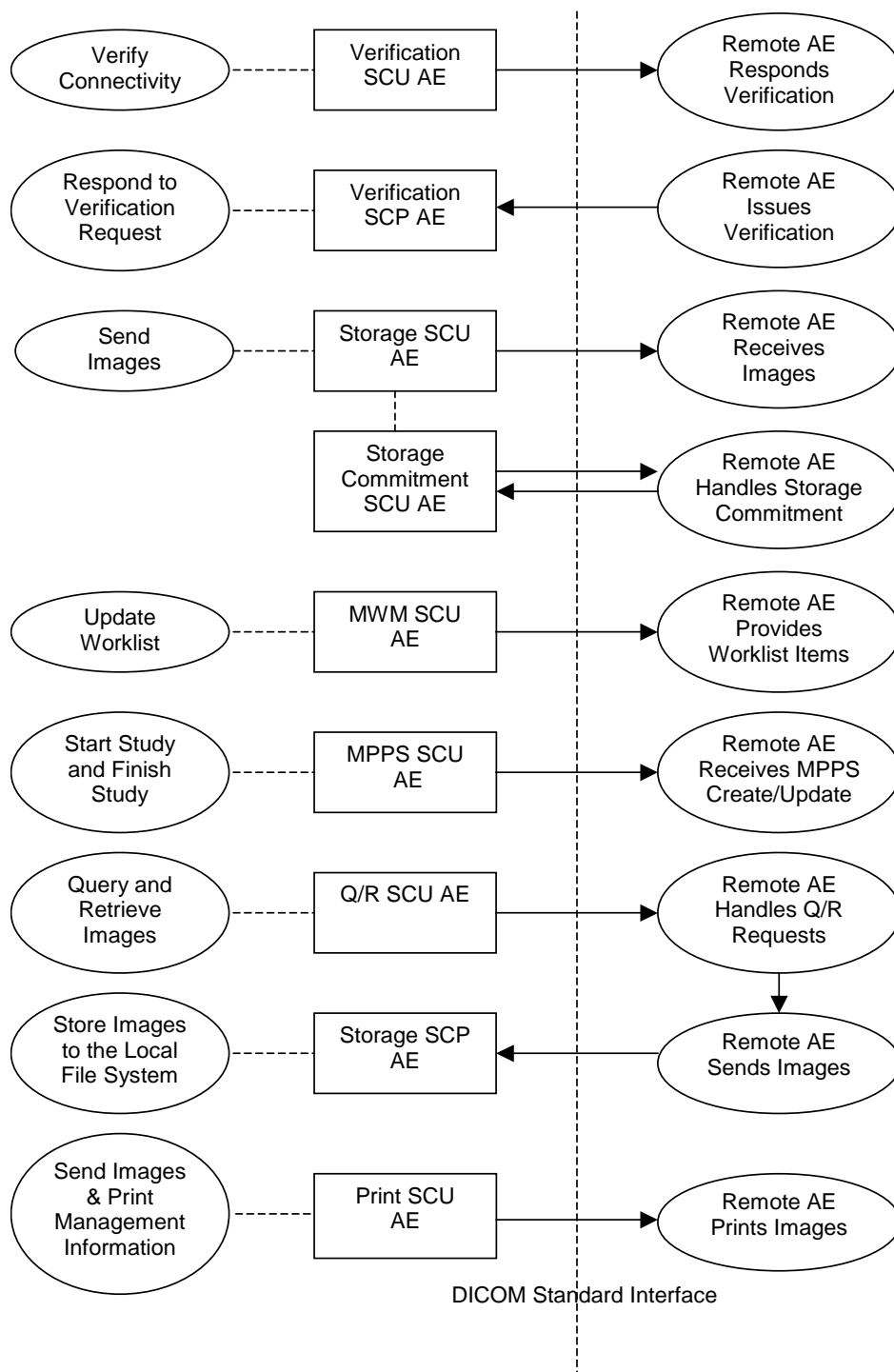

**Figure 4.1-1
APPLICATION DATA FLOW DIAGRAM**

- The Verification SCU AE issues a C-ECHO to verify a DICOM connection to a remote AE. It is associated with the local real-world activity “Verify Connectivity”. “Verify Connectivity” is performed via the Service Tool.
- The Verification SCP AE responds successfully to C-ECHO requests from known AE Titles. It is associated with the local real-world activity “Respond to Verification Request”
- The Storage SCU AE sends images to a remote AE. It is associated with the local real-world activity “Send Images”. “Send Images” is performed upon user request for specific images selected. If the remote AE is configured as a Storage Commitment SCP AE, the Storage SCU AE will send a storage commitment request to the Storage Commitment SCP AE.
- Receiving the storage commitment request from the Storage SCU AE, the Storage Commitment SCU AE will request Storage Commitment and if a commitment is successfully obtained will record this information in the local database.
- The MWM SCU AE receives Worklist information from a remote AE. It is associated with the local real-world activity “Update Worklist”. When the “Update Worklist” is performed the MWM SCU AE queries a remote AE for worklist items and provides the set of worklist items matching the query request. “Update Worklist” is performed as a result of an operator request and an automatic request.
- The MPPS SCU AE sends MPPS information to a remote AE. It is associated with the local real-world activity “Acquire Instances”. When the “Acquire Instances” is performed the MPPS SCU AE creates and updates Modality Performed Procedure Step instances managed by a remote AE. Acquisition of images will result in automated creation of an MPPS Instance. Completion of the MPPS is performed as the result of an operator action.
- The Q/R SCU AE queries a remote AE for lists of patients, studies, series and images and retrieves selected patients, studies, series or images. It is associated with the local real-world activity “Query and Retrieve Images”.
- The Storage SCP AE receives incoming images. It is associated with the local real-world activity “Store Images to the Local File System”. “Store Images to the Local File System” stores the received images to the local file system.
- The Print SCU AE prints images on a remote AE (Printer). It is associated with the local real-world activity “Send Images & Print Management Information”. “Send Images & Print Management Information” creates a print-job within the print queue containing one or more virtual film sheets composed from images selected by the user.

4.1.2 Functional Definition of AEs

4.1.2.1 Functional Definition of Verification SCU AE

The Verification SCU AE issues a C-ECHO to verify a DICOM connection to a remote AE. It is performed via the Service Tool and the local real-world activity "Send Images". Before sending images, the Verification SCU AE can be issue a C-ECHO to verify a DICOM connection to a remote AE with "ping" function.

4.1.2.2 Functional Definition of Verification SCP AE

The Verification SCP AE responds successfully to C-ECHO requests from known AE Titles, port numbers.

4.1.2.3 Functional Definition of Storage SCU AE

The existence of a send-job queue entry with associated network destination will activate the Storage SCU AE. An Association request is sent to the destination AE and upon successful negotiation of a Presentation Context the image transfer is started. If the image transfer fails, the Storage SCU AE will not retry this send-job automatically. If the remote AE is configured as an archive device, the storage SCU AE will send a storage commitment request to the Storage Commitment SCU AE. The Storage SCU AE can also issue C-ECHO requests as a Verification SCU before the image transfer independently.

4.1.2.4 Functional Definition of Storage Commitment SCU AE

Receiving the storage commitment request from the Storage SCU AE, the Storage Commitment SCU AE will request Storage Commitment and if a commitment is successfully obtained will record this information in the local database.

4.1.2.5 Functional Definition of MWM SCU AE

The MWM SCU AE attempts to download a worklist from a remote node. If the MWM SCU AE establishes an Association to a remote AE, it will transfer patient's information and worklist items via the open Association. The results will be displayed in a separate list. The patient's information will be used for the patient registration.

4.1.2.6 Functional Definition of MPPS SCU AE

The MPPS SCU AE performs the creation of an MPPS instance automatically when a study started. Further updates on the MPPS data can be performed automatically or interactively after finish study.

4.1.2.7 Functional Definition of Q/R SCU AE

The Q/R SCU AE is activated when the user selects a remote node to query and enters some key information, Patient's Name, Patient ID, Study Date, Study Time and Modality. The user can select patient, studies, series and images to be retrieved. The images will be received at the Storage SCP AE.

4.1.2.8 Functional Definition of Storage SCP AE

The Storage SCP AE waits for another application to connect at the presentation address configured for its AE Title. The Storage SCP AE will accept associations with Presentation Contexts for SOP Classes of the Storage Service Classes. Any images received on such Presentation Contexts will be stored to the local file system.

4.1.2.9 Functional Definition of Print AE

The existence of a print-job in the print queue will activate the Print SCU AE. An association is established with the printer and the printer's status determined. If the printer is operating normally, the film sheets described within the print-job will be printed. If the printer is not operating normally, this print-job can be canceled or restarted by the user operations.

4.1.3 Sequencing of Real-World Activities

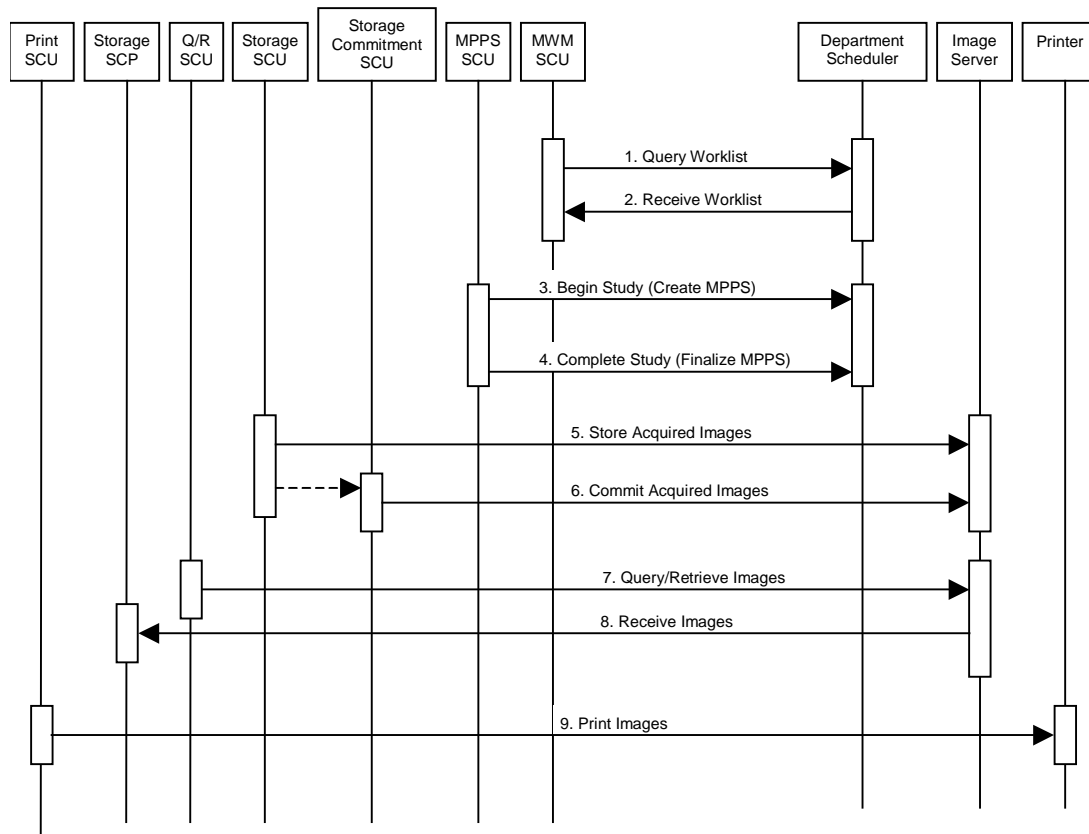

**Figure 4.1-2
SEQUENCING CONSTRAINTS**

Under typical scheduled workflow conditions the sequencing constraints illustrated in Figure 4.1-2 apply:

1. Query Worklist.
2. Select Workitem from Worklist.
3. Start Acquisition and Create MPPS.
4. Complete Acquisition and Finalize MPPS.
5. Store Acquired Images.
6. Commit Acquired Images.
7. Query/Retrieve Images.
8. Receive Images.
9. Print Images.

Other workflow situations (e.g. unscheduled procedure steps) will have other sequencing constraints. Some activities may be omitted according to situations.

4.2 AE SPECIFICATIONS

4.2.1 Verification SCU AE Specification

4.2.1.1 SOP Classes

The Verification SCU AE provides Standard Conformance to the following SOP Classes:

**Table 4.2-1
SOP CLASSES FOR THE VERIFICATION SCU AE**

SOP Class Name	SOP Class UID	SCU	SCP
Verification	1.2.840.10008.1.1	Yes	Yes

4.2.1.2 Association Policies

4.2.1.2.1 General

The DICOM standard application context name for DICOM 3.0 is always proposed:

**Table 4.2-2
DICOM APPLICATION CONTEXT FOR THE VERIFICATION SCU AE**

Application Context Name	1.2.840.10008.3.1.1.1
--------------------------	-----------------------

4.2.1.2.2 Number of Associations

The Verification SCU AE initiates one association at a time.

**Table 4.2-3
NUMBER OF ASSOCIATIONS INITIATED FOR THE VERIFICATION SCU AE**

Maximum number of simultaneous associations	1
---	---

4.2.1.2.3 Asynchronous Nature

The Verification SCU AE does not support asynchronous communication (multiple outstanding transactions over a single association).

**Table 4.2-4
ASYNCHRONOUS NATURE FOR THE VERIFICATION SCU AE**

Maximum number of outstanding asynchronous transactions	1
---	---

4.2.1.2.4 Implementation Identifying Information

The implementation information for the Verification SCU AE is:

**Table 4.2-5
DICOM IMPLEMENTATION CLASS AND VERSION FOR THE VERIFICATION SCU AE**

Implementation Class UID	1.2.392.200036.9116.7.8.12.10.31.1.1
Implementation Version Name	TM_INFINIX_V2.0

4.2.1.3 Association Initiation Policy

4.2.1.3.1 Activity – Verify Connectivity

4.2.1.3.1.1 Description and Sequencing of Activities

The Verification SCU AE attempts to initiate a new association in order to issue a verification request (C-ECHO) if needed.

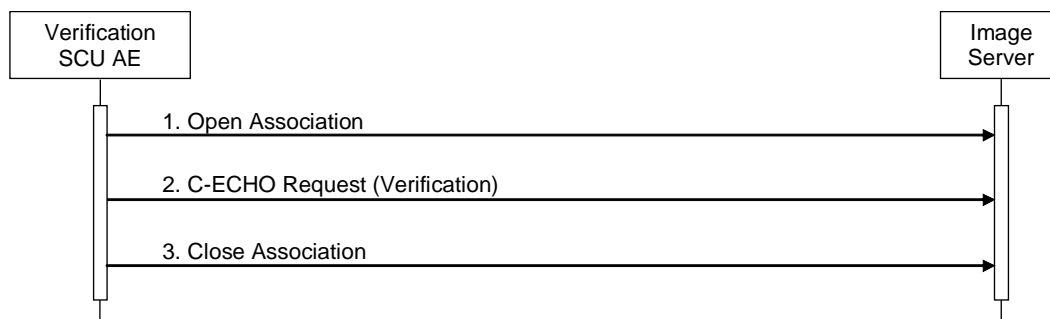

Figure 4.2-1
SEQUENCING OF ACTIVITY – VERIFY CONNECTIVITY

A possible sequence of interactions between the Verification SCU AE and an Image Server (e.g. a storage or archive device supporting the Verification SOP Classes as an SCP) is illustrated in the Figure above:

1. The Verification SCU AE opens an association with the Image Server.
2. The Verification SCU AE issues a verification request (C-ECHO) and the Image Server replies with a C-ECHO response (status success).
3. The Verification SCU AE closes the association with the Image Server.

4.2.1.3.1.2 Proposed Presentation Contexts

The Verification SCU AE will propose the Presentation Contexts shown in the following table:

Table 4.2-6
PROPOSED PRESENTATION CONTEXTS FOR ACTIVITY VERIFY CONNECTIVITY

Presentation Context Table					
Abstract Syntax		Transfer Syntax		Role	Ext. Neg.
Name	UID	Name List	UID List		
Verification	1.2.840.10008.1.1	Implicit VR Little Endian	1.2.840.10008.1.2	SCU	None
		Explicit VR Little Endian	1.2.840.10008.1.2.1		

4.2.1.3.1.3 SOP Specific Conformance for Verification SOP Class

The Verification SCU AE provides standard conformance to the Verification Service Class as an SCU.

The behavior of Verification SCU AE when encountering status codes in a C-ECHO response is summarized in the table below:

Table 4.2-7
VERIFICATION RESPONSE STATUS HANDLING BEHAVIOR

Service Status	Further Meaning	Status Code	Behavior
Success	Success	0000	The Verification SCU AE judges the remote AE is present and active on the network.

The behavior of Verification SCU AE during communication failure is summarized in the table below:

Table 4.2-8
VERIFICATION COMMUNICATION FAILURE BEHAVIOR

Exception	Behavior
Timeout	The association is aborted and the failure reason is logged and reported to the user.
Association aborted by the SCP or network layers	The failure reason is logged and reported to the user.

4.2.2 Verification SCP AE Specification

4.2.2.1 SOP Classes

The Verification SCP AE provides Standard Conformance to the following SOP Classes:

Table 4.2-9
SOP CLASSES FOR THE VERIFICATION SCP AE

SOP Class Name	SOP Class UID	SCU	SCP
Verification	1.2.840.10008.1.1	No	Yes

4.2.2.2 Association Policies

4.2.2.2.1 General

The DICOM standard application context name for DICOM 3.0 is always proposed:

Table 4.2-10
DICOM APPLICATION CONTEXT FOR THE VERIFICATION SCP AE

Application Context Name	1.2.840.10008.3.1.1.1
--------------------------	-----------------------

4.2.2.2.2 Number of Associations

Table 4.2-11
NUMBER OF ASSOCIATIONS ACCEPTED FOR THE VERIFICATION SCP AE

Maximum number of simultaneous associations	Unlimited
---	-----------

4.2.2.2.3 Asynchronous Nature

The Verification SCP AE does not support asynchronous communication (multiple outstanding transactions over a single association).

Table 4.2-12
ASYNCHRONOUS NATURE FOR THE VERIFICATION SCP AE

Maximum number of outstanding asynchronous transactions	1
---	---

4.2.2.2.4 Implementation Identifying Information

The implementation information for the Verification SCP AE is:

Table 4.2-13
DICOM IMPLEMENTATION CLASS AND VERSION FOR THE VERIFICATION SCP AE

Implementation Class UID	1.2.392.200036.9116.7.8.12.10.31.1.1
Implementation Version Name	TM_INFINIX_V2.0

4.2.2.3 Association Initiation Policy

The Verification SCP AE does not initiate associations.

4.2.2.4 Association Acceptance Policy

4.2.2.4.1 Activity – Respond to Verification Request

4.2.2.4.1.1 Description and Sequencing of Activities

When the Verification SCP AE accepts an association, it will respond to a verification request (C-ECHO).

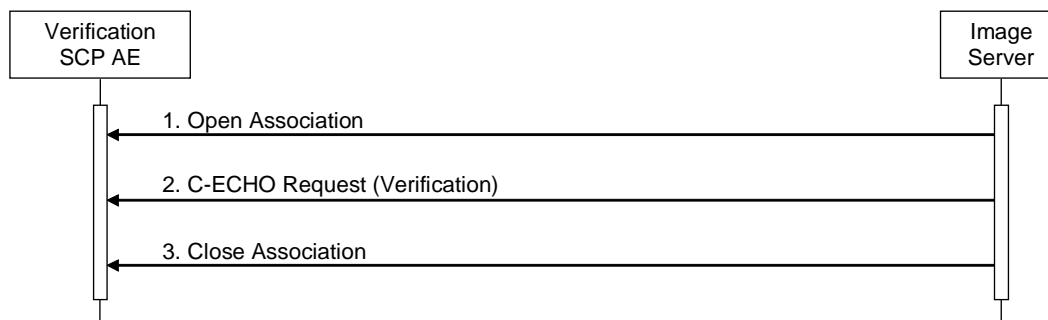

Figure 4.2-2
SEQUENCING OF ACTIVITY – RESPOND TO VERIFICATION REQUEST

A possible sequence of interactions between the Verification SCP AE and an Image Server (e.g. a storage or archive device supporting the Verification SOP Classes as an SCU) is illustrated in the Figure above:

1. The Image Server opens an association with the Verification SCP AE.
2. The Image Server issues a verification request (C-ECHO) and the Verification SCP AE replies with a C-ECHO response (status success).
3. The Image Server closes the association with the Verification SCP AE.

The Verification SCP AE may reject association attempts as shown in the table below. The Result, Source and Reason/Diag columns represent the values returned in the appropriate fields of an ASSOCIATE-RJ PDU (see PS 3.8, Section 9.3.4). The contents of the Source column is abbreviated to save space and the meaning of the abbreviations are:

Table 4.2-14
ASSOCIATION REJECTION REASONS

Result	Source	Reason/Diag	Explanation
1 – rejected-permanent	DICOM UL service-user	3 – calling-AE-title-not-recognized	The association request contained an unrecognized calling AE Title. An association request with the same parameters will not succeed at a later time unless configuration changes are made. This rejection reason normally occurs when the association acceptor has not been configured to recognize the AE Title of the association initiator.
1 – rejected-permanent	DICOM UL service-provider (ASCE related function)	1 – no-reason-given	The association request could not be parsed. An association request with the same format will not succeed at a later time.

4.2.2.4.1.2 Accepted Presentation Contexts

The default behavior of the Verification SCP AE supports the Implicit VR Little Endian and Explicit VR Little Endian transfer syntaxes. If the both transfer syntaxes are proposed per presentation context then the Verification SCP AE will select Explicit VR Little Endian transfer syntax.

Table 4.2-15

PROPOSED PRESENTATION CONTEXTS FOR ACTIVITY RESPOND TO VERIFICATION REQUEST

Presentation Context Table					
Abstract Syntax		Transfer Syntax		Role	Ext. Neg.
Name	UID	Name List	UID List		
Verification	1.2.840.10008.1.1	Implicit VR Little Endian	1.2.840.10008.1.2	SCP	None
		Explicit VR Little Endian	1.2.840.10008.1.2.1		

4.2.2.4.1.3 SOP Specific Conformance for Verification SOP Class

The Verification SCP AE provides standard conformance to the Verification Service Class as an SCP.

4.2.3 Storage SCU AE Specification

4.2.3.1 SOP Classes

The Storage SCU AE provides Standard Conformance to the following SOP Classes:

Table 4.2-16
SOP CLASSES FOR THE STORAGE SCU AE

SOP Class Name	SOP Class UID	SCU	SCP
XA Image Storage	1.2.840.10008.5.1.4.1.1.12.1	Yes	Yes
X-Ray Radiation Dose SR	1.2.840.10008.5.1.4.1.1.188.67	Yes	No

4.2.3.2 Association Policies

4.2.3.2.1 General

The DICOM standard application context name for DICOM 3.0 is always proposed:

Table 4.2-17
DICOM APPLICATION CONTEXT FOR THE STORAGE SCU AE

Application Context Name	1.2.840.10008.3.1.1.1
--------------------------	-----------------------

4.2.3.2.2 Number of Associations

The Storage SCU AE can initiate only one association at a time for each destination to which a transfer request is being processed in the active job queue list. Up to two jobs, that images will be sent to the different remote hosts, will be active at a time, the other remains pending until the active job is completed or failed.

Table 4.2-18
NUMBER OF ASSOCIATIONS INITIATED FOR THE STORAGE SCU AE

Maximum number of simultaneous Associations	1
---	---

4.2.3.2.3 Asynchronous Nature

The Storage SCU AE does not support asynchronous communication (multiple outstanding transactions over a single Association).

Table 4.2-19
ASYNCHRONOUS NATURE FOR THE STORAGE SCU AE

Maximum number of outstanding asynchronous transactions	1
---	---

4.2.3.2.4 Implementation Identifying Information

The implementation information for the Storage SCU AE is:

Table 4.2-20
DICOM IMPLEMENTATION CLASS AND VERSION FOR THE STORAGE SCU AE

Implementation Class UID	1.2.392.200036.9116.7.8.12.10.31.1.1
Implementation Version Name	TM_INFINIX_V2.0

4.2.3.3 Association Initiation Policy

4.2.3.3.1 Activity – Send Images

4.2.3.3.1.1 Description and Sequencing of Activities

The Storage SCU AE attempts to initiate a new Association in order to issue a Storage request (C-STORE). If the job contains multiple images then single C-STORE requests will be issued over the separate Association. If the image transfer fails, the Storage SCU AE will not retry this send-job automatically.

The Storage SCU AE also attempts to initiate a new Association in order to issue a ping (ICMP) request and Verification request (C-ECHO) if needed.



Figure 4.2-3
SEQUENCING OF ACTIVITY – SEND IMAGES

A possible sequence of interactions between the Storage SCU AE and an Image Server (e.g. a storage or archive device supporting the Storage SOP Classes as an SCP) is illustrated in the Figure above:

1. The Storage SCU AE opens an Association with the Image Server.
2. Acquired images are transmitted to the Image Server using a Storage request (C-STORE) and the Image Server replies with a C-STORE response (status success).
3. The Storage SCU AE closes the Association with the Image Server.

4.2.3.3.1.2 Proposed Presentation Contexts

The Storage SCU AE is capable of proposing the Presentation Contexts shown in the following table:

**Table 4.2-21
PROPOSED PRESENTATION CONTEXTS FOR ACTIVITY SEND IMAGES**

Presentation Context Table					
Abstract Syntax		Transfer Syntax		Role	Ext. Neg.
Name	UID	Name List	UID List		
XA Image Storage	1.2.840.10008.5.1.4.1.1.12.1	Implicit VR Little Endian	1.2.840.10008.1.2	SCU	None
		Explicit VR Little Endian	1.2.840.10008.1.2.1		
		JPEG Lossless (Process 14[Section Value1])	1.2.840.10008.1.2.4.70		
X-Ray Radiation Dose SR	1.2.840.10008.5.1.4.1.1.88.67	Implicit VR Little Endian	1.2.840.10008.1.2	SCU	None
		Explicit VR Little Endian	1.2.840.10008.1.2.1		

4.2.3.3.1.3 SOP Specific Conformance for Verification SOP Class

The Storage SCU AE provides standard conformance to the Verification Service Class as an SCU. It is initiated by manual operation.

The behavior of Storage SCU AE when encountering status codes in a C-ECHO response is summarized in the Table below:

**Table 4.2-22
VERIFICATION C-ECHO RESPONSE STATUS HANDLING BEHAVIOR**

Service Status	Further Meaning	Status Code	Behavior
Success	Success	0000	The Storage SCU AE judges the remote AE is present and active on the network.

The behavior of Storage SCU AE during communication failure is summarized in the Table below:

**Table 4.2-23
VERIFICATION COMMUNICATION FAILURE BEHAVIOR**

Exception	Behavior
Timeout	The Association is aborted using A-ABORT and the send job is marked as failed. The reason is logged and the job failure is reported to the user via the job control application.
Association aborted by the SCP or network layers	The send job is marked as failed. The reason is logged and the job failure is reported to the user via the job control application.

4.2.3.3.1.4 SOP Specific Conformance for Storage SOP Classes

The Storage SCU AE provides standard conformance to the Storage Service Class as an SCU.

The behavior of Storage SCU AE when encountering status codes in a C-STORE response is summarized in the Table below:

Table 4.2-24
STORAGE C-STORE RESPONSE STATUS HANDLING BEHAVIOR

Service Status	Further Meaning	Status Code	Behavior
Success	Success	0000	The SCP has successfully stored the SOP Instance. If all SOP Instances in a send job have status success then the job is marked as complete.
Refused	Out of Resources	A7xxH	The Association is aborted using A-ABORT and the send job is marked as failed. The status meaning is logged and the job failure is reported to the user via the job control application. This is a transient failure.
Error	Data Set does not match SOP Class	A9xxH	The Association is aborted using A-ABORT and the send job is marked as failed. The status meaning is logged and the job failure is reported to the user via the job control application.
Error	Cannot Understand	CxxxH	The Association is aborted using A-ABORT and the send job is marked as failed. The status meaning is logged and the job failure is reported to the user via the job control application.
Warning	Coercion of Data Elements	B000H	Image transmission is considered successful if it is configured that the status would be considered successful.
Warning	Data Set does not match SOP Class	B007H	Image transmission is considered successful if it is configured that the status would be considered successful.
Warning	Elements Discarded	B006H	Image transmission is considered successful if it is configured that the status would be considered successful.
*	*	Any other status code.	The Association is aborted using A-ABORT and the send job is marked as failed. The status code is logged and the job failure is reported to the user via the job control application.

The behavior of Storage SCU AE during communication failure is summarized in the Table below:

Table 4.2-25
STORAGE COMMUNICATION FAILURE BEHAVIOR

Exception	Behavior
Timeout	The Association is aborted using A-ABORT and the send job is marked as failed. The reason is logged and the job failure is reported to the user via the job control application.
Association aborted by the SCP or network layers	The send job is marked as failed. The reason is logged and the job failure is reported to the user via the job control application.

If the image transfer fails, the Storage SCU AE will not retry this send-job automatically.

The contents of Image Storage SOP Instances created by the Storage SCU AE conform to the DICOM Image IOD definitions and are described in section 8.1.

4.2.4 Storage Commitment SCU AE Specification

4.2.4.1 SOP Classes

The Storage Commitment SCU AE provides Standard Conformance to the following SOP Classes:

Table 4.2-26
SOP CLASSES FOR THE STORAGE COMMITMENT SCU AE

SOP Class Name	SOP Class UID	SCU	SCP
Storage Commitment Push Model	1.2.840.10008.1.20.1	Yes	No

4.2.4.2 Association Policies

4.2.4.2.1 General

The DICOM standard application context name for DICOM 3.0 is always proposed:

Table 4.2-27
DICOM APPLICATION CONTEXT FOR THE STORAGE COMMITMENT SCU AE

Application Context Name	1.2.840.10008.3.1.1.1
--------------------------	-----------------------

4.2.4.2.2 Number of Associations

The Storage Commitment SCU AE initiates one Association at a time.

Table 4.2-28
NUMBER OF ASSOCIATIONS INITIATED FOR THE STORAGE COMMITMENT SCU AE

Maximum number of simultaneous Associations	1
---	---

The Storage Commitment SCU AE accepts Associations to receive N-EVENT-REPORT notifications for the Storage Commitment Push Model SOP Class.

Table 4.2-29
NUMBER OF ASSOCIATIONS ACCEPTED FOR THE STORAGE COMMITMENT SCU AE

Maximum number of simultaneous Associations	1
---	---

4.2.4.2.3 Asynchronous Nature

The Storage Commitment SCU AE does not support asynchronous communication (multiple outstanding transactions over a single Association).

Table 4.2-30
ASYNCHRONOUS NATURE FOR THE STORAGE COMMITMENT SCU AE

Maximum number of outstanding asynchronous transactions	1
---	---

4.2.4.2.4 Implementation Identifying Information

The implementation information for the Storage Commitment SCU AE is:

Table 4.2-31
DICOM IMPLEMENTATION CLASS AND VERSION FOR THE STORAGE COMMITMENT SCU AE

Implementation Class UID	1.2.392.200036.9116.7.8.12.10.31.1.1
Implementation Version Name	TM_INFINIX_V2.0

4.2.4.3 Association Initiation Policy

4.2.4.3.1 Activity – Commit Sent Images

4.2.4.3.1.1 Description and Sequencing of Activities

If the remote AE is configured as a Storage Commitment SCP AE, the Storage Commitment SCU AE will transmit a single Storage Commitment request (N-ACTION) over another Association after each image have been sent. Upon receiving the N-ACTION response the Storage Commitment SCU AE will release the Association. The notification of Storage commitment (N-EVENT-REPORT) will be received over a separate Association.

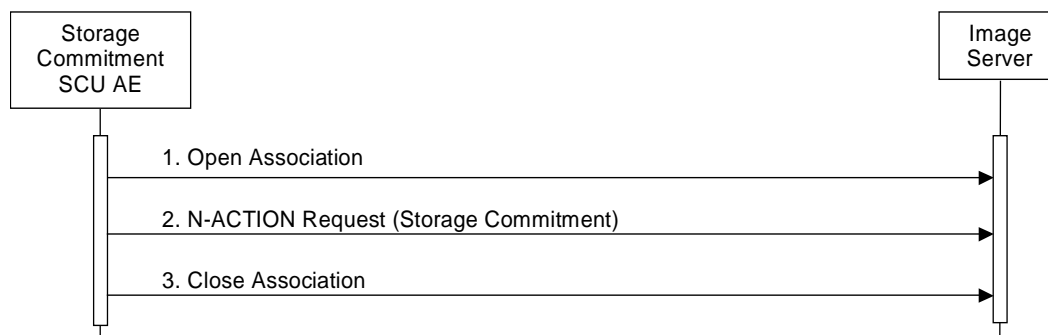

Figure 4.2-4
SEQUENCING OF ACTIVITY – COMMIT SENT IMAGES

A possible sequence of interactions between the Storage Commitment SCU AE and an Image Server (e.g. a storage or archive device supporting the Storage Commitment SOP Classes as an SCP) is illustrated in the Figure above:

1. The Storage Commitment SCU AE opens an Association with the Image Server.
2. A Storage Commitment request (N-ACTION) is transmitted to the Image Server to obtain Storage Commitment of previously transmitted image. The Image Server replies with an N-ACTION response indicating the request has been received and is being processed.
3. The Storage Commitment AE closes the Association with the Image Server.

NOTE: The N-EVENT-REPORT will be sent over a separate Association initiated by the Image Server (see Section 4.2.4.4.1).

4.2.4.3.1.2 Proposed Presentation Contexts

The Storage Commitment SCU AE is capable of proposing the Presentation Contexts shown in the following table:

Table 4.2-32
PROPOSED PRESENTATION CONTEXTS FOR ACTIVITY COMMIT SENT IMAGES

Presentation Context Table					
Abstract Syntax		Transfer Syntax		Role	Ext. Neg.
Name	UID	Name List	UID List		
Storage Commitment Push Model	1.2.840.10008.1.20.1	Implicit VR Little Endian Explicit VR Little Endian	1.2.840.10008.1.2 1.2.840.10008.1.2.1	SCU	None

A Presentation Context for the Storage Commitment Push Model will only be proposed if the remote AE is configured as a Storage Commitment SCP AE.

4.2.4.3.1.3 SOP Specific Conformance for Storage Commitment SOP Class

4.2.4.3.1.3.1 Storage Commitment Operations (N-ACTION)

The Storage Commitment SCU AE provides standard conformance to the Storage Commitment Service Class as an SCU.

The Storage Commitment SCU AE will request storage commitment for instances of the Storage SOP Classes if the remote AE is configured as a Storage Commitment SCP AE and a presentation context for the Storage Commitment Push Model has been accepted.

The behavior of Storage SCU Commitment AE when encountering status codes in a N-ACTION response is summarized in the Table below:

**Table 4.2-33
STORAGE COMMITMENT N-ACTION RESPONSE STATUS HANDLING BEHAVIOR**

Service Status	Further Meaning	Status Code	Behavior
Success	Success	0000	The request for storage commitment is considered successfully sent. A timer is started which will expire if no N-EVENT-REPORT for the Transaction UID is received within a configurable timeout period.
*	*	Any other status code.	The Association is aborted using A-ABORT and the request for storage commitment is marked as failed.

The behavior of Storage Commitment AE during communication failure is summarized in the Table below:

**Table 4.2-34
STORAGE COMMITMENT COMMUNICATION FAILURE BEHAVIOR**

Exception	Behavior
Timeout	The Association is aborted using A-ABORT and the send job is marked as failed. The reason is logged and the job failure is reported to the user via the job control application.
Association aborted by the SCP or network layers	The send job is marked as failed. The reason is logged and the job failure is reported to the user via the job control application.

4.2.4.4 Association Acceptance Policy

4.2.4.4.1 Activity – Receive Storage Commitment Response

4.2.4.4.1.1 Description and Sequencing of Activities

The Storage Commitment SCU AE will accept Associations in order to receive responses to a Storage Commitment Request.

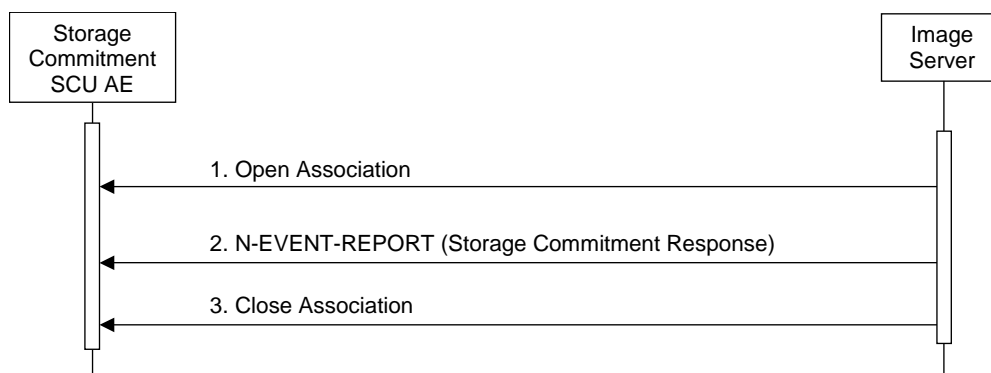

Figure 4.2-5
SEQUENCING OF ACTIVITY - RECEIVE STORAGE COMMITMENT RESPONSE

A possible sequence of interactions between the Storage Commitment SCU AE and an Image Server (e.g. a storage or archive device supporting Storage Commitment SOP Classes as an SCP) is illustrated in the Figure above:

1. The Image Server opens a new Association with the Storage Commitment SCU AE.
2. The Image Server sends an N-EVENT-REPORT request notifying the Storage SCU AE of the status of a previous Storage Commitment Request. The Storage SCU AE replies with a N-EVENT-REPORT response confirming receipt.
3. The Image Server closes the Association with the Storage Commitment SCU AE.

The Storage Commitment SCU AE may reject Association attempts as shown in the Table below. The Result, Source and Reason/Diag columns represent the values returned in the appropriate fields of an ASSOCIATE-RJ PDU (see PS 3.8, Section 9.3.4). The contents of the Source column is abbreviated to save space and the meaning of the abbreviations are:

- a) 1 – DICOM UL service-user
- b) 2 – DICOM UL service-provider (ASCE related function)
- c) 3 – DICOM UL service-provider (Presentation related function)

Table 4.2-35
ASSOCIATION REJECTION REASONS

Result	Source	Reason/Diag	Explanation
2 – rejected-transient	c	2 – local-limit-exceeded	The (configurable) maximum number of simultaneous Associations has been reached. An Association request with the same parameters may succeed at a later time.

2 – rejected-transient	c	1 – temporary-congestion	No Associations can be accepted at this time due to the real-time requirements of higher priority activities (e.g. during image acquisition no Associations will be accepted) or because insufficient resources are available (e.g. memory, processes, threads). An Association request with the same parameters may succeed at a later time.
1 – rejected-permanent	a	2 – application-context-name-not-supported	The Association request contained an unsupported Application Context Name. An Association request with the same parameters will not succeed at a later time.
1 – rejected-permanent	a	7 – called-AE-title-not-recognized	The Association request contained an unrecognized Called AE Title. An Association request with the same parameters will not succeed at a later time unless configuration changes are made. This rejection reason normally occurs when the Association initiator is incorrectly configured and attempts to address the Association acceptor using the wrong AE Title.
1 – rejected-permanent	a	3 – calling-AE-title-not-recognized	The Association request contained an unrecognized Calling AE Title. An Association request with the same parameters will not succeed at a later time unless configuration changes are made. This rejection reason normally occurs when the Association acceptor has not been configured to recognize the AE Title of the Association initiator.
1 – rejected-permanent	b	1 – no-reason-given	The Association request could not be parsed. An Association request with the same format will not succeed at a later time.

4.2.4.4.1.2 Accepted Presentation Contexts

The Storage Commitment SCU AE will accept Presentation Contexts as shown in the Table below.

**Table 4.2-36
ACCEPTABLE PRESENTATION CONTEXTS FOR
ACTIVITY RECEIVE STORAGE COMMITMENT RESPONSE**

Presentation Context Table					
Abstract Syntax		Transfer Syntax		Role	Ext. Neg.
Name	UID	Name List	UID List		
Storage Commitment Push Model	1.2.840.10008.1.20.1	Implicit VR Little Endian Explicit VR Little Endian	1.2.840.10008.1.2 1.2.840.10008.1.2.1	SCU	None

A Presentation Context for the Storage Commitment Push Model will only be proposed if the remote AE is configured as a Storage Commitment SCP AE.

4.2.4.4.1.3 SOP Specific Conformance for Storage Commitment SOP Class

4.2.4.4.1.3.1 Storage Commitment Notifications (N-EVENT-REPORT)

The Storage Commitment SCU AE provides standard conformance to the Storage Commitment Service Class as an SCU.

The behavior of Storage Commitment SCU AE when receiving Event Types within the N-EVENT-REPORT is summarized in the Table below.

Table 4.2-37
STORAGE COMMITMENT N-EVENT-REPORT BEHAVIOUR

Event Type Name	Event Type ID	Behavior
Storage Commitment Request Successful	1	The Storage Commitment SCU AE permits the operator(s) to delete the Referenced SOP Instances under Referenced SOP Sequence (0018,1199), or deletes the Instances from the local database automatically.
Storage Commitment Request Complete – Failures Exist	2	The Storage Commitment SCU AE requests the Storage SCU AE to send the Referenced SOP Instances under Failed SOP Sequence (0018,1198).

The reasons for returning specific status codes in a N-EVENT-REPORT response are summarized in the Table below.

Table 4.2-38
STORAGE COMMITMENT N-EVENT-REPORT RESPONSE STATUS REASONS

Service Status	Further Meaning	Status Code	Reasons
Success	Success	0000	The storage commitment result has been successfully received.
Failure	Unrecognized Operation	0211H	The Transaction UID in the N-EVENT-REPORT request is not recognized (was never issued within an N-ACTION request).
Failure	Resource Limitation	0213H	The Transaction UID in the N-EVENT-REPORT request has expired (no N-EVENT-REPORT was received within a configurable time limit).
Failure	No Such Event Type	0113H	An invalid Event Type ID was supplied in the N-EVENT-REPORT request.
Failure	Processing Failure	0110H	An internal error occurred during processing of the N-EVENT-REPORT. A short description of the error will be returned in Error Comment (0000,0902).
Failure	Invalid Argument Value	0115H	One or more SOP Instance UIDs with the Referenced SOP Sequence (0008,1199) or Failed SOP Sequence (0008,1198) was not included in the Storage Commitment Request associated with this Transaction UID. The unrecognized SOP Instance UIDs will be returned within the Event Information of the N-EVENT-REPORT response.

4.2.5 MWM SCU AE Specification

4.2.5.1 SOP Classes

The MWM SCU AE provides Standard Conformance to the following SOP Classes:

Table 4.2-39
SOP CLASSES FOR THE MWM SCU AE

SOP Class Name	SOP Class UID	SCU	SCP
Modality Worklist Information Model – FIND	1.2.840.10008.5.1.4.31	Yes	No

4.2.5.2 Association Policies

4.2.5.2.1 General

The DICOM standard application context name for DICOM 3.0 is always proposed:

Table 4.2-40
DICOM APPLICATION CONTEXT FOR THE MWM SCU AE

Application Context Name	1.2.840.10008.3.1.1.1
--------------------------	-----------------------

4.2.5.2.2 Number of Associations

The MWM SCU AE initiates one Association at a time for a Worklist request.

Table 4.2-41
NUMBER OF ASSOCIATIONS INITIATED FOR THE MWM SCU AE

Maximum number of simultaneous Associations	1
---	---

4.2.5.2.3 Asynchronous Nature

The MWM SCU AE does not support asynchronous communication (multiple outstanding transactions over a single Association).

Table 4.2-42
ASYNCHRONOUS NATURE FOR THE MWM SCU AE

Maximum number of outstanding asynchronous transactions	1
---	---

4.2.5.2.4 Implementation Identifying Information

The implementation information for this Application Entity is:

Table 4.2-43
DICOM IMPLEMENTATION CLASS AND VERSION FOR THE MWM SCU AE

Implementation Class UID	1.2.392.200036.9116.7.8.12.10.31.1.1
Implementation Version Name	TM_INFINIX_V2.0

4.2.5.3 Association Initiation Policy

4.2.5.3.1 Activity – Update Worklist

4.2.5.3.1.1 Description and Sequencing of Activities

The request for a “Update Worklist” is initiated by user interaction, i.e. pressing the buttons “Refresh” or automatically at the time of previous “Update Worklist”.

Upon initiation of the request, the MWM SCU AE will build an Identifier for the C-FIND request, will initiate an association to send the request and will wait for Worklist responses. After retrieval of all responses, the MWM SCU AE will access the local database to update patient demographic data. The results will be displayed in a separate list.

The MWM SCU AE will initiate an Association in order to issue a C-FIND request according to the Modality Worklist Information Model.

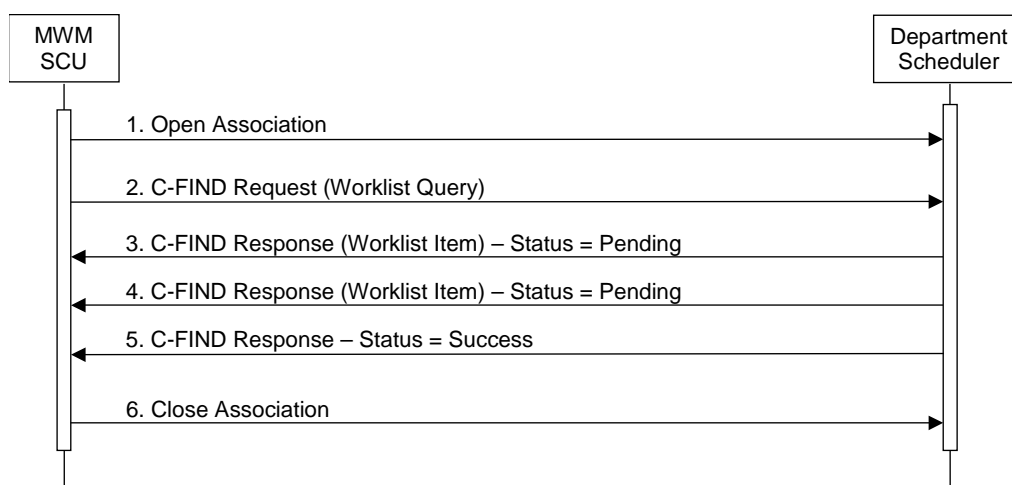

Figure 4.2-6
SEQUENCING OF ACTIVITY – UPDATE WORKLIST

A possible sequence of interactions between the MWM SCU AE and a Department Scheduler (e.g. a device such as a RIS or HIS which supports the Modality Worklist SOP Class as an SCP) is illustrated in the Figure above:

1. The MWM SCU AE opens an association with the Department Scheduler
2. The MWM SCU AE sends a C-FIND request to the Department Scheduler containing the Worklist Query attributes.
3. The Department Scheduler returns a C-FIND response containing the requested attributes of the first matching Worklist Item.
4. The Department Scheduler returns another C-FIND response containing the requested attributes of the second matching Worklist Item.
5. The Department Scheduler returns another C-FIND response with status Success indicating that no further matching Worklist Items exist. This example assumes that only 2 Worklist items match the Worklist Query.
6. The MWM SCU AE closes the association with the Department Scheduler.

4.2.5.3.1.2 Proposed Presentation Contexts

The MWM SCU AE will propose Presentation Contexts as shown in the following table:

Table 4.2-44
Proposed Presentation Contexts for Activity Update Worklist

Presentation Context Table					
Abstract Syntax		Transfer Syntax		Role	Ext. Neg.
Name	UID	Name List	UID List		
Modality Worklist Information Model – FIND	1.2.840.10008.5.1.4.31	Implicit VR Little Endian Explicit VR Little Endian	1.2.840.10008.1.2 1.2.840.10008.1.2.1	SCU	None

4.2.5.3.1.3 SOP Specific Conformance for Modality Worklist SOP Class

The MWM SCU AE provides standard conformance to the Modality Worklist SOP Class as an SCU.

The behavior of the MWM SCU when encountering status codes in a Modality Worklist C-FIND response is summarized in the Table below.

**Table 4.2-45
Modality Worklist C-FIND Response Status Handling Behavior**

Service Status	Further Meaning	Status Code	Behavior
Success	Matching is complete	0000	The SCP has completed the matches. Worklist items are available for display or further processing.
Refused	Out of Resources	A700H	The Association is aborted using A-ABORT and the worklist query is marked as failed. The status meaning is logged and reported to the user if an interactive query. Any additional error information in the Response will be logged.
Failed	Identifier does not match SOP Class	A900H	The Association is aborted using A-ABORT and the worklist query is marked as failed. The status meaning is logged and reported to the user if an interactive query. Any additional error information in the Response will be logged.
Failed	Unable to Process	CxxxH	The Association is aborted using A-ABORT and the worklist query is marked as failed. The status meaning is logged and reported to the user if an interactive query. Any additional error information in the Response will be logged.
Cancel	Matching terminated due to Cancel request	FE00H	If the query was cancelled due to too many worklist items then the SCP has completed the matches. Worklist items are available for display or further processing. Otherwise, the Association is aborted using A-ABORT and the worklist query is marked as failed. The status meaning is logged and reported to the user if an interactive query.
Pending	Matches are continuing	FF00H	The worklist item contained in the Identifier is collected for later display or further processing.
Pending	Matches are continuing – Warning that one or more Optional Keys were not supported	FF01H	The worklist item contained in the Identifier is collected for later display or further processing. The status meaning is logged only once for each C-FIND operation.
*	*	Any other status code.	The Association is aborted using A-ABORT and the worklist is marked as failed. The status meaning is logged and reported to the user if an interactive query. Any additional error information in the Response will be logged.

The behavior of the MWM SCU AE during communication failure is summarized in the Table below.

Table 4.2-46
MODALITY WORKLIST COMMUNICATION FAILURE BEHAVIOR

Exception	Behavior
Timeout	The Association is aborted using A-ABORT and the worklist query is marked as failed. The reason is logged and reported to the user if an interactive query.
Association aborted by the SCP or network layers	The worklist query is marked as failed. The reason is logged and reported to the user if an interactive query.

The Table below provides a description of the MWM SCU AE Worklist Request Identifier and specifies the attributes that are copied into the images. Unexpected attributes returned in a C-FIND response are ignored.

Table 4.2-47
WORKLIST REQUEST IDENTIFIER

Module Name Attribute Name	Tag	VR	M	R	D	IOD
SOP Common						
Specific Character Set	(0008,0005)	CS		x		x
Scheduled Procedure Step						
Scheduled Procedure Step Sequence	(0040,0100)	SQ		x	x	
> Scheduled Station AE Title	(0040,0001)	AE	S	x		
> Scheduled Station Name	(0040,0010)	LO		x		
> Scheduled Procedure Step Location	(0040,0011)	SH		x	x	
> Scheduled Procedure Step Start Date	(0040,0002)	DA	S, R	x	x	
> Scheduled Procedure Step Start Time	(0040,0003)	TM		x	x	
> Scheduled Procedure Step End Date	(0040,0004)	DA		x		
> Scheduled Procedure Step End Time	(0040,0005)	TM		x		
> Scheduled Performing Physician's Name	(0040,0006)	PN	S, x	x	x	
> Scheduled Procedure Step Description	(0040,0007)	SH		x	x	x
> Scheduled Protocol Code Sequence	(0040,0008)	SQ		x		x
>> Code Value	(0008,0100)	SH		x		
>> Coding Scheme Designator	(0008,0102)	SH		x		
>> Coding Scheme Version	(0008,0103)	SH		x		
>> Code Meaning	(0008,0104)	LO		x		
> Scheduled Procedure Step ID	(0040,0009)	SH		x	x	x
> Scheduled Procedure Step Status	(0040,0020)	CS		x		
> Comments on Scheduled Procedure Step	(0040,0400)	LT		x		
> Modality	(0008,0060)	CS	S	x	x	x
> Requested Contrast Agent	(0032,1070)	LO		x		x
> Pre-Medication	(0040,0012)	LO		x		
Requested Procedure						

Requested Procedure ID	(0040,1001)	SH	x	x	x	x
Reason for the Requested Procedure	(0040,1002)	LO		x		
Requested Procedure Comments	(0040,1400)	LT		x	x	
Requested Procedure Code Sequence	(0032,1064)	SQ		x		
> Code Value	(0008,0100)	SH		x		
> Coding Scheme Designator	(0008,0102)	SH		x		
> Coding Scheme Version	(0008,0103)	SH		x		
> Code Meaning	(0008,0104)	LO		x		
Referenced Study Sequence	(0008,1110)	SQ		x		
> Referenced SOP Class UID	(0008,1150)	UI		x		
> Referenced SOP Instance UID	(0008,1155)	UI		x		
Requested Procedure Description	(0032,1060)	LO		x	x	
Study Instance UID	(0020,000D)	UI		x		x
Requested Procedure Priority	(0040,1003)	SH		x	x	
Patient Transport Arrangements	(0040,1004)	LO		x		
Requested Procedure Location	(0040,1005)	LO		x		
Confidentiality Code	(0040,1008)	LO		x		
Reporting Priority	(0040,1009)	SH		x		
Names of Intended Recipients of Results	(0040,1010)	PN		x	x	
Imaging Service Request						
Reason for the Imaging Service Request	(0040,2001)	LO		x		
Imaging Service Request Comments	(0040,2400)	LT		x		
Requesting Physician	(0032,1032)	PN		x	x	
Referring Physician's Name	(0008,0090)	PN		x	x	x
Requesting Service	(0032,1033)	LO		x	x	x
Accession Number	(0008,0050)	SH	x	x	x	x
Issue Date of Imaging Service Request	(0040,2004)	DA		x		
Issue Time of Imaging Service Request	(0040,2005)	TM		x		
Order Entered By	(0040,2008)	PN		x		
Order Enters Location	(0040,2009)	SH		x		
Order Callback Phone Number	(0040,2010)	SH		x		
Placer Order Number / Imaging Service Request	(0040,2016)	LO		x		
Filter Order Number / Imaging Service Request	(0040,2017)	LO		x		
Visit Relationship						
Referenced Patient Sequence	(0008,1120)	SQ		x		
> Referenced SOP Class UID	(0008,1150)	UI		x		
> Referenced SOP Instance UID	(0008,1155)	UI		x		
Visit Identification						
Institution Name	(0008,0080)	LO		x		
Institution Address	(0008,0081)	ST		x		
Institution Code Sequence	(0008,0082)	SQ		x		
> Code Value	(0008,0100)	SH		x		
> Coding Scheme Designator	(0008,0102)	SH		x		
> Coding Scheme Version	(0008,0103)	SH		x		
> Code Meaning	(0008,0104)	LO		x		
Admission ID	(0038,0010)	LO		x		
Issuer of Admission ID	(0038,0011)	LO		x		
Visit Status						
Visit Status ID	(0038,0008)	CS				
Current Patient Location	(0038,0300)	LO		x	x	
Patient's Institution Residence	(0038,0400)	LO				
Visit Comments	(0038,4000)	LT				
Visit Admission						

Referring Physician's Address	(0008,0092)	ST		x		
Referring Physician's Telephone Number	(0008,0094)	SH		x		
Admitting Diagnosis Description	(0008,1080)	LO		x	x	
Admitting Diagnosis Code Sequence	(0008,1084)	SQ		x		
> Code Value	(0008,0100)	SH		x		
> Coding Scheme Designator	(0008,0102)	SH		x		
> Coding Scheme Version	(0008,0103)	SH		x		
> Code Meaning	(0008,0104)	LO		x		
Route of Admissions	(0038,0016)	LO		x		
Admitting Date	(0038,0020)	DA		x		
Admitting Time	(0038,0021)	TM		x		
Patient Relationship						
Referenced Patient Alias Sequence	(0038,0004)	SQ		x		
> Referenced SOP Class UID	(0008,1150)	UI		x		
> Referenced SOP Instance UID	(0008,1155)	UI		x		
Patient Identification						
Patient's Name	(0010,0010)	PN	x	x	x	x
Patient ID	(0010,0020)	LO	x	x	x	x
Issuer of Patient ID	(0010,0021)	LO		x		
Other Patient IDs	(0010,1000)	LO		x	x	x
Other Patient Names	(0010,1001)	PN		x	x	x
Patient's Birth Name	(0010,1005)	PN		x		x
Patient's Mother's Birth Name	(0010,1060)	PN		x		x
Medical Record Locator	(0010,1090)	LO		x		
Patient Demographic						
Patient's Age	(0010,1010)	AS		x	x	x
Occupation	(0010,2180)	SH		x	x	
Patient Data Confidentiality Constraint Description	(0040,3001)	LO		x		
Patient's Birth Date	(0010,0030)	DA		x	x	x
Patient's Birth Time	(0010,0032)	TM		x		
Patient's Sex	(0010,0040)	CS		x	x	x
Patient's Insurance Plan Code Sequence	(0010,0050)	SQ		x		
> Code Value	(0008,0100)	SH		x		
> Coding Scheme Designator	(0008,0102)	SH		x		
> Coding Scheme Version	(0008,0103)	SH		x		
> Code Meaning	(0008,0104)	LO		x		
Patient's Size	(0010,1020)	DS		x	x	x
Patient's Weight	(0010,1030)	DS		x	x	x
Patient's Address	(0010,1040)	LO		x		x
Military Rank	(0010,1080)	LO		x		
Branch of Service	(0010,1081)	LO		x		
Country Residence	(0010,2150)	LO		x		
Region of Residence	(0010,2152)	LO		x		
Patient's Telephone Number	(0010,2154)	SH		x		
Ethnic Group	(0010,2160)	SH		x	x	
Patient's Religious Reference	(0010,21F0)	LO		x		
Patient Comment	(0010,4000)	LT		x	x	x
Patient Medical						
Medical Alerts	(0010,2000)	LO		x	x	
Contrast Allergies	(0010,2110)	LO		x	x	x
Smoking Status	(0010,21A0)	CS		x		x
Additional Patient History	(0010,21B0)	LT		x	x	
Pregnancy Status	(0010,21C0)	US		x	x	x
Last Menstrual Date	(0010,21D0)	DA		x		
Special Needs	(0038,0050)	LO		x		
Patient State	(0038,0500)	LO		x		

The above table should be read as follows:

- Module Name: The name of the associated module for supported worklist attributes.
- Attribute Name: Attributes supported to build the MWM SCU AE Worklist Request Identifier.
- Tag: DICOM tag for this attribute.
- VR: DICOM VR for this attribute.
- M: Matching keys for (automatic) Worklist Update. An "S" will indicate that the MWM SCU AE will supply an attribute value for Single Value Matching, a "R" will indicate Range Matching and an "x" will indicate Wildcard Matching. This setting can be selected the device user interface. The system's default setting is described in the above table.
- R: Return keys. An "x" will indicate that the MWM SCU AE will supply this attribute as Return Key with zero length for Universal Matching. This setting can be configured using the service tool. The system's default setting is described in the above table.
- D: Displayed keys. An "x" indicates that this worklist attribute is displayed to the user during a patient registration dialog. For example, Patient Name will be displayed when registering the patient prior to an examination. This setting can be configured using the service tool. The system's default setting is described in the above table.
- IOD: An "x" indicates that this Worklist attribute is included into all Object Instances created during performance of the related Procedure Step. This setting can be configured using the service tool. The system's default setting is described in the above table.

4.2.5.4 Association Acceptance Policy

The MWM SCU AE does not accept Associations.

4.2.6 MPPS SCU AE Specification

4.2.6.1 SOP Classes

The MPPS SCU AE provides Standard Conformance to the following SOP Classes:

Table 4.2-48
SOP CLASSES FOR THE MPPS SCU AE

SOP Class Name	SOP Class UID	SCU	SCP
Modality Performed Procedure Step	1.2.840.10008.3.1.2.3.3	Yes	No
Modality Performed Procedure Step Retrieve	1.2.840.10008.3.1.2.3.4	Yes	No

4.2.6.2 Association Policies

4.2.6.2.1 General

The DICOM standard application context name for DICOM 3.0 is always proposed:

Table 4.2-49
DICOM APPLICATION CONTEXT FOR THE MPPS SCU AE

Application Context Name	1.2.840.10008.3.1.1.1
--------------------------	-----------------------

4.2.6.2.2 Number of Associations

The MPPS SCU AE initiates one Association at a time.

Table 4.2-50
NUMBER OF ASSOCIATIONS INITIATED FOR THE MPPS SCU AE

Maximum number of simultaneous Associations	1
---	---

4.2.6.2.3 Asynchronous Nature

The MPPS SCU AE does not support asynchronous communication (multiple outstanding transactions over a single Association).

Table 4.2-51
ASYNCHRONOUS NATURE FOR THE MPPS SCU AE

Maximum number of outstanding asynchronous transactions	1
---	---

4.2.6.2.4 Implementation Identifying Information

The implementation information for this Application Entity is:

Table 4.2-52
DICOM IMPLEMENTATION CLASS AND VERSION FOR THE MPPS SCU AE

Implementation Class UID	1.2.392.200036.9116.7.8.12.10.31.1.1
Implementation Version Name	TM_INFUNIX_V2.0

4.2.6.3 Association Initiation Policy

4.2.6.3.1 Activity – Acquire Instances

4.2.6.3.1.1 Description and Sequencing of Activities

The MPPS SCU AE performs the creation of a MPPS Instance automatically when the user starts the study. Further updates on the MPPS data can be performed when the user completes the study.

The MPPS SCU AE will initiate an Association to issue an:

- N-CREATE request according to the CREATE Modality Performed Procedure Step SOP Instance operation, or an:
- N-SET request to update the contents and state of the MPPS according to the SET Modality Performed Procedure Step Information operation.

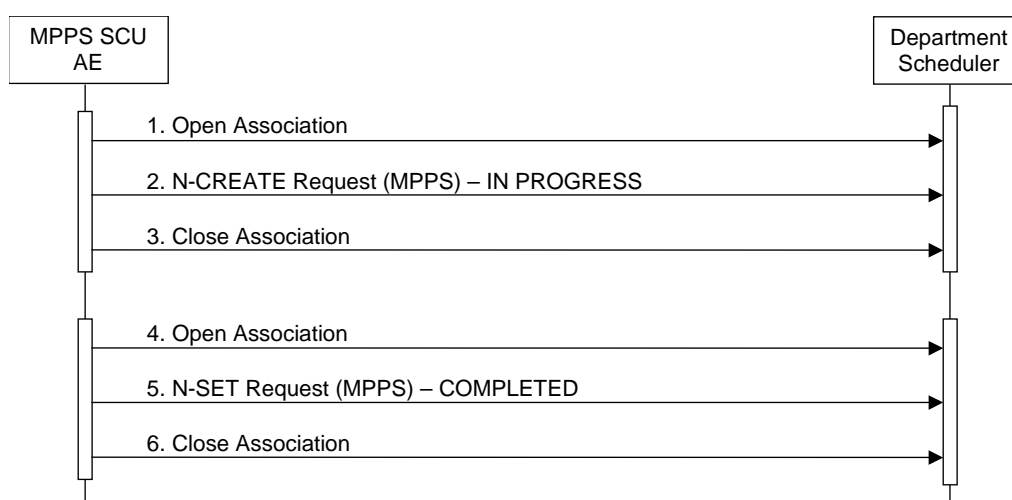

Figure 4.2-7
SEQUENCING OF ACTIVITY – ACQUIRE INSTANCES

A possible sequence of interactions between the MPPS SCU AE and a Department Scheduler (e.g. a device such as a RIS or HIS which supports the MPPS SOP Class as an SCP) is illustrated in the Figure above:

1. The MPPS SCU AE opens an association with the Department Scheduler
2. The MPPS SCU AE sends an N-CREATE request to the Department Scheduler to create an MPPS instance with status of "IN PROGRESS" and create all necessary attributes. The Department Scheduler acknowledges the MPPS creation with an N-CREATE response (status success).
3. The MPPS SCU AE closes the association with the Department Scheduler.
4. The MPPS SCU AE opens an association with the Department Scheduler.
5. The MPPS SCU AE sends an N-SET request to the Department Scheduler to update the MPPS instance with status of "COMPLETED" or "DISCONTINUED" and set all necessary attributes. The Department Scheduler acknowledges the MPPS update with an N-SET response (status success).
6. The MPPS SCU AE closes the association with the Department Scheduler.

4.2.6.3.1.2 Proposed Presentation Contexts

The MPPS SCU AE will propose Presentation Contexts as shown in the following Table:

**Table 4.2-53
PROPOSED PRESENTATION CONTEXTS FOR REAL-WORLD ACTIVITY ACQUIRE IMAGES**

Presentation Context Table					
Abstract Syntax		Transfer Syntax		Role	Ext. Neg.
Name	UID	Name List	UID List		
Modality Performed Procedure Step	1.2.840.10008.3.1.2.3.3	Implicit VR Little Endian	1.2.840.10008.1.2	SCU	None
		Explicit VR Little Endian	1.2.840.10008.1.2.1		
Modality Performed Procedure Step Retrieve	1.2.840.10008.3.1.2.3.4	Implicit VR Little Endian	1.2.840.10008.1.2	SCU	None
		Explicit VR Little Endian	1.2.840.10008.1.2.1		

4.2.6.3.1.3 SOP Specific Conformance for MPPS SOP Class

The MPPS SCU AE provides standard conformance to the Modality Performed Procedure Step SOP Class as an SCU.

The behavior of the MPPS SCU AE when encountering status codes in an MPPS N-CREATE or N-SET response is summarized in the Table below.

**Table 4.2-54
MPPS N-CREATE / N-SET RESPONSE STATUS HANDLING BEHAVIOR**

Service Status	Further Meaning	Status Code	Behavior
Success	Success	0000	The SCP has completed the operation successfully.
Failure	Processing Failure – Performed Procedure Step Object may no longer be updated	0110H	The Association is aborted using A-ABORT and the MPPS is marked as failed. The status meaning is logged and reported to the user. Additional information in the Response will be logged (i.e. Error Comment and Error ID).
Warning	Attribute Value Out of Range	0116H	The MPPS operation is considered successful if it is configured that the status would be considered successful.
*	*	Any other status code.	The Association is aborted using A-ABORT and the MPPS is marked as failed. The status meaning is logged and reported to the user.

The behavior of the MPPS SCU AE during communication failure is summarized in the Table below:

**Table 4.2-55
MPPS COMMUNICATION FAILURE BEHAVIOR**

Exception	Behavior
Timeout	The Association is aborted using A-ABORT and MPPS is marked as failed. The reason is logged and reported to the user.
Association aborted by the SCP or network layers	The MPPS is marked as failed. The reason is logged and reported to the user.

Acquired images will always use the Study Instance UID specified for the Scheduled Procedure Step (if available). If an acquisition is unscheduled, a Study Instance UID will be generated locally.

The Table below provides a description of the MPPS N-CREATE and N-SET request identifiers sent by the MPPS SCU AE. Empty cells in the N-CREATE and N-SET columns indicate that the attribute is not sent. An "x" indicates that an appropriate value will be sent. A "Zero length" attribute will be sent with zero length.

Table 4.2-56
MPPS N-CREATE / N-SET REQUEST IDENTIFIER

Attribute Name	Tag	VR	N-CREATE	N-SET
Specific Character Set	(0008,0005)	CS	Created, if an extended or replacement character set is used. Refer to 6.SUPPORT OF CHARACTER SETS	
Performed Procedure Step Relationship				
Scheduled Step Attributes Sequence	(0040,0270)	SQ	Always Set	
> Study Instance UID	(0020,000D)	UI	From Modality Worklist	
> Referenced Study Sequence	(0008,1110)	SQ	From Modality Worklist	
>> Referenced SOP Class UID	(0008,1150)	UI	From Modality Worklist	
>> Referenced SOP Instance UID	(0008,1155)	UI	From Modality Worklist	
> Accession Number	(0008,0050)	SH	From Modality Worklist	
> Placer Order Number/Imaging Service Request	(0040,2016)	LO	From Modality Worklist	
> Filler Order Number/Imaging Service Request	(0040,2017)	LO	From Modality Worklist	
> Requested Procedure ID	(0040,1001)	SH	From Modality Worklist	
> Requested Procedure Description	(0032,1060)	LO	From Modality Worklist	
> Scheduled Procedure Step ID	(0040,0009)	SH	From Modality Worklist	
> Scheduled Procedure Step Description	(0040,0007)	LO	From Modality Worklist	
> Scheduled Protocol Code Sequence	(0040,0008)	SQ	From Modality Worklist	
>>Code Value	(0008,0100)	SH	From Modality Worklist	
>>Coding Scheme Designator	(0008,0102)	SH	From Modality Worklist	
>>Coding Scheme Version	(0008,0103)	SH	From Modality Worklist	
>>Code Meaning	(0008,0104)	LO	From Modality Worklist	
Patient's Name	(0010,0010)	PN	From Modality Worklist or user input	
Patient ID	(0010,0020)	LO	From Modality Worklist or user input.	
Patient's Birth Date	(0010,0030)	DA	From Modality Worklist or user input.	
Patient's Sex	(0010,0040)	CS	From Modality Worklist or user input.	
Referenced Patient Sequence	(0008,1120)	SQ	From Modality Worklist.	
>Referenced SOP Class UID	(0008,1150)	UI	From Modality Worklist	
>Referenced SOP Instance UID	(0008,1155)	UI	From Modality Worklist	
Performed Procedure Step Information				
Performed Procedure Step ID	(0040,0253)	SH	Automatically created.	

Performed Station AE Title	(0040,0241)	AE	MPPS AE Title	
Performed Station Name	(0040,0242)	SH	From configuration	
Performed Location	(0040,0243)	SH	From configuration	
Performed Procedure Step Start Date	(0040,0244)	DA	Actual start date	
Performed Procedure Step Start Time	(0040,0245)	TM	Actual start time	
Performed Procedure Step Status	(0040,0252)	CS	IN PROGRESS	COMPLETED or DISCONTINUED
Performed Procedure Step Description	(0040,0254)	LO	From Modality Worklist.	
Performed Procedure Type Description	(0040,0255)	LO	From Modality Worklist.	
Procedure Code Sequence	(0008,1032)	SQ	Zero or more items	Zero or more items
>>Code Value	(0008,0100)	SH		
>>Coding Scheme Designator	(0008,0102)	SH		
>>Coding Scheme Version	(0008,0103)	SH		
>>Code Meaning	(0008,0104)	LO		
Performed Procedure Step End Date	(0040,0250)	DA	Zero length	Actual end date
Performed Procedure Step End Time	(0040,0251)	TM	Zero length	Actual end time
Comments on the Performed Procedure Steps	(0040,0280)	ST	Zero length	x
Image Acquisition Results				
Modality	(0008,0060)	CS	XA	
Study ID	(0020,0010)	SH	From Modality Worklist or automatically created.	
Performed Protocol Code Sequence	(0040,0260)	SQ	Zero or more items	Zero or more items
>>Code Value	(0008,0100)	SH		x
>>Coding Scheme Designator	(0008,0102)	SH		x
>>Coding Scheme Version	(0008,0103)	SH		x
>>Code Meaning	(0008,0104)	LO		x
Performed Series Sequence	(0040,0340)	SQ	Zero length	One or more items
> Performing Physician's Name	(0008,1050)	PN		x
> Protocol Name	(0018,1030)	LO		x
> Operator's Name	(0008,1070)	PN		x
> Series Instance UID	(0020,000E)	UI		x
> Series Description	(0008,103E)	LO		x
> Retrieve AE Title	(0008,0054)	AE		x
> Referenced Image Sequence	(0008,1140)	SQ		One or more items
>> Referenced SOP Class UID	(0008,1150)	UI		x
>> Referenced SOP Instance UID	(0008,1155)	UI		x

> Referenced Non-Image Composite SOP Instance Sequence	(0040,0220)	SQ		One or more items
>> Referenced SOP Class UID	(0008,1150)	UI		x
>> Referenced SOP Instance UID	(0008,1155)	UI		x
Radiation Dose				
Total Time of Fluoroscopy	(0040,0300)	US		x
Total Number of Exposures	(0040,0301)	US		x
Entrance Dose	(0040,0302)	US		x
Entrance Dose in mGy	(0040,8302)	DS		x
Image Area Dose Product	(0018,115E)	DS		x
Comments on Radiation Dose	(0040,0310)	ST		x
Exposure Dose Sequence	(0040,030E)	SQ		Zero or more items
>KVp	(0018,0060)	DS		X
>Exposure Time	(0018,1150)	IS		x
>X-ray Tube Current	(0018,1151)	IS		x
Billing and Material Code				
Billing Procedure Step Sequence	(0040,0320)	SQ		Zero or more items
>Code Value	(0008,0100)	SH		x
>Coding Scheme Designator	(0008,0102)	SH		x
>Coding Scheme Version	(0008,0103)	SH		x
>Code Meaning	(0008,0104)	LO		x
Film Consumption Sequence	(0040,0321)	SQ		Zero or more items
>Number of Films	(2100,0170)	IS		x
>Medium Type	(2000,0030)	CS		x
>Film Size ID	(2010,0050)	CS		x
Billing Supplies and Devices Sequence	(0040,0324)	SQ		Zero or more items
>Quantity Sequence	(0040,0293)	SQ		x
>>Quantity	(0040,0294)	DS		x
>>Measuring Units Sequence	(0040,0295)	SQ		Zero or more items
>>>Code Value	(0008,0100)	SH		x
>>>Coding Scheme Designator	(0008,0102)	SH		x
>>>Coding Scheme Version	(0008,0103)	SH		x
>>>Code Meaning	(0008,0104)	LO		x
Billing Item Sequence	(0040,0296)	SQ		Zero or more items
>>Code Value	(0008,0100)	SH		x
>>Coding Scheme Designator	(0008,0102)	SH		x
>>Coding Scheme Version	(0008,0103)	SH		x
>>Code Meaning	(0008,0104)	LO		x

4.2.6.4 Association Acceptance Policy

The MPPS SCU AE does not accept Associations.

4.2.7 Q/R SCU AE Specification

4.2.7.1 SOP Classes

The Q/R SCU AE provides Standard Conformance to the following SOP Classes:

**Table 4.2-57
SOP CLASSES FOR THE Q/R SCU AE**

SOP Class Name	SOP Class UID	SCU	SCP
Patient Root Q/R Information Model – Find	1.2.840.10008.5.1.4.1.2.1.1	Yes	No
Patient Root Q/R Information Model – Move	1.2.840.10008.5.1.4.1.2.1.2	Yes	No

4.2.7.2 Association Policies

4.2.7.2.1 General

The DICOM standard application context name for DICOM 3.0 is always proposed:

**Table 4.2-58
DICOM APPLICATION CONTEXT FOR THE Q/R SCU AE**

Application Context Name	1.2.840.10008.3.1.1.1
--------------------------	-----------------------

4.2.7.2.2 Number of Associations

The Q/R SCU AE can initiate up to three Associations at a time.

**Table 4.2-59
NUMBER OF ASSOCIATIONS INITIATED FOR THE Q/R SCU AE**

Maximum number of simultaneous Associations	1
---	---

4.2.7.2.3 Asynchronous Nature

The Q/R SCU AE does not support asynchronous communication (multiple outstanding transactions over a single Association).

**Table 4.2-60
ASYNCHRONOUS NATURE FOR THE Q/R SCU AE**

Maximum number of outstanding asynchronous transactions	1
---	---

4.2.7.2.4 Implementation Identifying Information

The implementation information for this Application Entity is:

**Table 4.2-61
DICOM IMPLEMENTATION CLASS AND VERSION FOR THE Q/R SCU AE**

Implementation Class UID	1.2.392.200036.9116.7.8.12.10.31.1.1
Implementation Version Name	TM_INFUNIX_V2.0

4.2.7.3 Association Initiation Policy

4.2.7.3.1 Activity – Query and Retrieve Images

4.2.7.3.1.1 Description and Sequencing of Activities

The Q/R SCU AE is activated when the user selects a remote node to query and enters some key information, Patient’s Name, Patient ID and/or Study Date. The user can select studies, series and images to be retrieved. The images will be received at the Storage SCP AE. The system requests Image Level Move only.

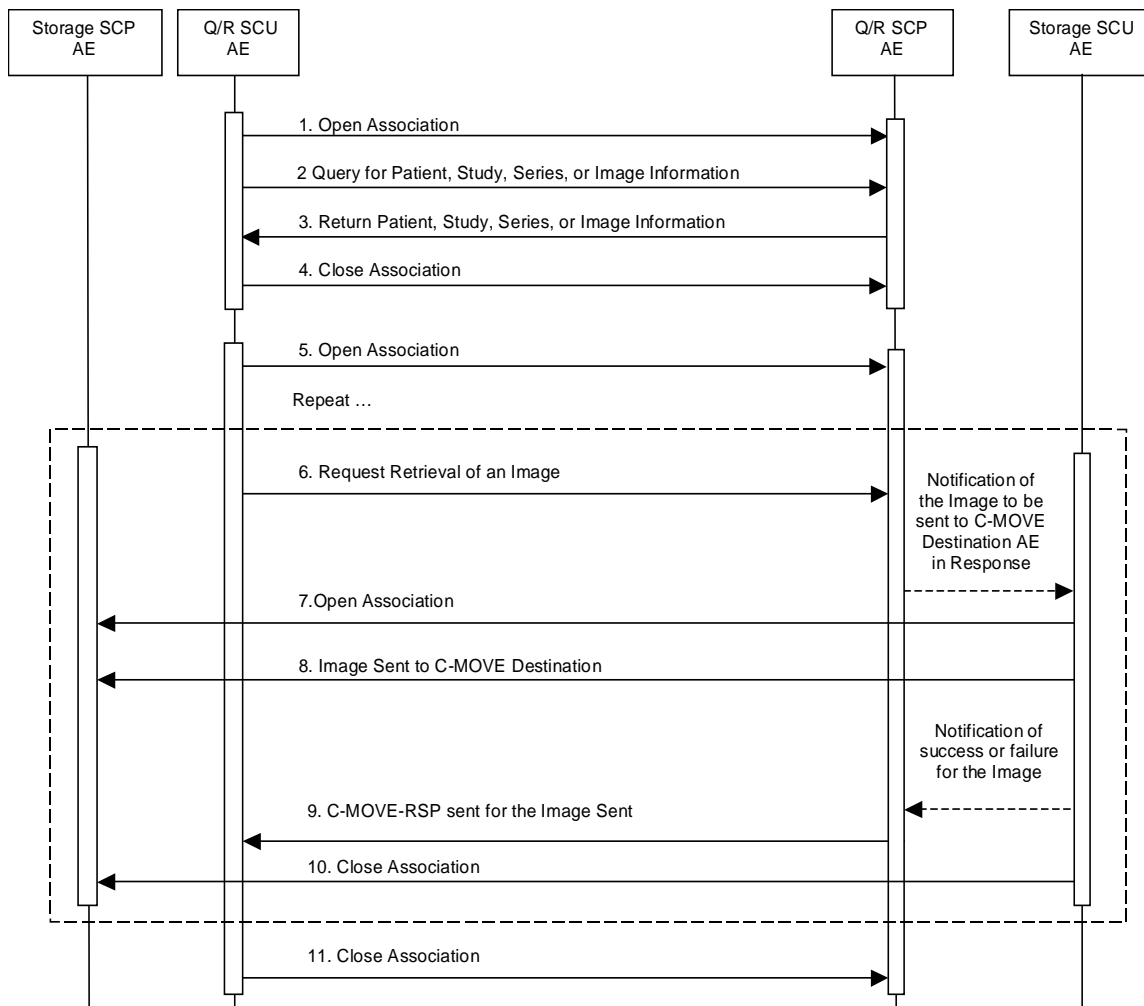

Figure 4.2-8
SEQUENCING OF ACTIVITY – QUERY AND RETRIEVE IMAGES

The following sequencing constraints illustrated in the Figure above:

1. The Q/R SCU AE opens an Association with the Q/R SCP AE.
2. The Q/R SCU AE sends a C-FIND-RQ Message
3. The Q/R SCP AE returns a C-FIND-RSP Message to the Q/R SCU AE with matching information. A C-FIND-RSP is sent for each entity matching the identifier specified in the C-FIND-RQ. A final C-FIND-RSP is sent indicating that the matching is complete.
4. The Q/R SCU AE closes the Association.
5. The Q/R SCU AE opens an Association with the Q/R SCP AE.
6. The Q/R SCU AE sends a C-MOVE-RQ Message. The Q/R SCP AE notifies the Storage SCU AE to send the Composite SOP Instances to the peer C-MOVE Destination AE as indicated in the C-MOVE-RQ.
7. The Storage SCU AE opens an Association with the C-MOVE Destination AE.
8. The Storage SCU AE sends images to the C-MOVE Destination AE. The Storage SCU AE indicates to the Q/R SCP AE whether the transfer succeeded or failed.
9. The Q/R SCP AE then returns a C-MOVE-RSP indicating this success or failure.
10. The Storage SCU AE closes the Association.
11. The Q/R SCU AE closes the Association.

4.2.7.3.1.2 Proposed Presentation Contexts

The Q/R SCU AE will propose Presentation Contexts as shown in the following Table:

Table 4.2-62
PROPOSED PRESENTATION CONTEXTS FOR REAL-WORLD ACTIVITY
QUERY AND RETRIEVE IMAGES

Presentation Context Table					
Abstract Syntax		Transfer Syntax		Role	Ext. Neg.
Name	UID	Name List	UID List		
Patient Root Q/R Information Model – Find	1.2.840.10008.5.1.4.1.2.1.1	Implicit VR Little Endian	1.2.840.10008.1.2	SCU	None
		Explicit VR Little Endian	1.2.840.10008.1.2.1		
Patient Root Q/R Information Model – Move	1.2.840.10008.5.1.4.1.2.1.2	Implicit VR Little Endian	1.2.840.10008.1.2	SCU	None
		Explicit VR Little Endian	1.2.840.10008.1.2.1		

4.2.7.3.1.3 SOP Specific Conformance for Q/R Find SOP Classes

The Q/R SCU AE provides standard conformance to the Query/Retrieve Find SOP Classes as an SCU.

The behavior of the Q/R SCU AE when encountering status codes in a Q/R C-FIND response is summarized in the Table below:

**Table 4.2-63
THE Q/R SCU AE C-FIND RESPONSE STATUS BEHAVIOR**

Service Status	Further Meaning	Status Code	Behavior
Success	Matching is complete	0000	The SCP has completed the matches. Worklist items are available for display or further processing.
Refused	Out of Resources	A700H	The Association is aborted using A-ABORT and the worklist query is marked as failed. The status meaning is logged and reported to the user if an interactive query. Any additional error information in the Response will be logged.
Failed	Identifier does not match SOP Class	A900H	The Association is aborted using A-ABORT and the worklist query is marked as failed. The status meaning is logged and reported to the user if an interactive query. Any additional error information in the Response will be logged.
Failed	Unable to Process	CxxxH	The Association is aborted using A-ABORT and the worklist query is marked as failed. The status meaning is logged and reported to the user if an interactive query. Any additional error information in the Response will be logged.
Cancel	Matching terminated due to Cancel request	FE00H	If the query was cancelled due to too many worklist items then the SCP has completed the matches. Worklist items are available for display or further processing. Otherwise, the Association is aborted using A-ABORT and the worklist query is marked as failed. The status meaning is logged and reported to the user if an interactive query.
Pending	Matches are continuing	FF00H	The worklist item contained in the Identifier is collected for later display or further processing.
Pending	Matches are continuing – Warning that one or more Optional Keys were not supported	FF01H	The worklist item contained in the Identifier is collected for later display or further processing. The status meaning is logged only once for each C-FIND operation.
*	*	Any other status code.	The Association is aborted using A-ABORT and the worklist is marked as failed. The status meaning is logged and reported to the user if an interactive query. Any additional error information in the Response will be logged.

The behavior of the Q/R SCU AE during communication failure is summarized in the Table below.

Table 4.2-64
Q/R FIND COMMUNICATION FAILURE BEHAVIOR

Exception	Behavior
Timeout	The Association is aborted using A-ABORT and the patient, the study, series or image query is marked as failed. The reason is logged and reported to the user if an interactive query.
Association aborted by the SCP or network layers	The patient, the study, series or image query is marked as failed. The reason is logged and reported to the user if an interactive query.

All queries are initiated at the highest level of the information model (the PATIENT level), and then for each response received, recursively repeated at the next lower levels (the STUDY, the SERIES and then IMAGE levels), in order to completely elucidate the "tree" of instances available on the remote AE.

The Table below provides a description of the Q/R SCU AE C-FIND Request Identifier.

Table 4.2-65
PATIENT ROOT REQUEST IDENTIFIER FOR C-FIND-SCU

Name	Tag	Types of Matching
Patient Level		
Patient ID	(0010,0020)	S,*,U
Patient's Name	(0010,0010)	S,*,U
Patient's Birth Date	(0010,0030)	S,U,R
Patient's Sex	(0010,0040)	S,*,U
Ethnic Group	(0010,2160)	S,*,U
Patient Comments	(0010,4000)	*,U
Number of Patient Related Studies	(0020,1200)	U
Number of Patient Related Series	(0020,1202)	U
Number of Patient Related Instances	(0020,1204)	U
Study Level		
Study ID	(0020,0010)	S,*,U
Study Description	(0008,1030)	S,*,U
Modalities in Study	(0008,0061)	*,U
Study Date	(0008,0020)	S,U,R
Study Time	(0008,0030)	S,U,R
Referring Physician's Name	(0008,0090)	S,*,U
Accession Number	(0008,0050)	S,*,U
Name of Physician(s) Reading Study	(0008,1060)	S,*,U
Patient's Age	(0010,1010)	S,*,U
Patient's Size	(0010,1020)	S,U
Patient's Weight	(0010,1030)	S,U
Occupation	(0010,2180)	S,*,U
Additional Patient History	(0010,21B0)	*,U
Study Instance UID	(0020,000D)	UNIQUE
Number of Study Related Series	(0020,1206)	U
Number of Study Related Instances	(0020,1208)	U
Series Level		
Series Number	(0020,0011)	S,U
Series Description	(0008,103E)	S,*,U
Modality	(0008,0060)	S,*,U
Series Date	(0008,0021)	S,U,R
Series Time	(0008,0031)	S,U,R
Performing Physician's Name	(0008,1050)	S,*,U
Protocol Name	(0018,1030)	S,*,U
Operator's Name	(0008,1070)	S,*,U
Number of Series Related Instances	(0020,1209)	U
Image Level		

Instance Number	(0020,0013)	S,U
Image Comments	(0020,4000)	U
Content Date	(0008,0023)	S,U,R
Content Time	(0008,0033)	S,U,R
SOP Instance UID	(0008,0018)	UNIQUE
Modality	(0008,0060)	S,*,U

Types of Matching:

The types of Matching supported by the Q/R SCU AE. An "S" indicates the identifier attribute uses Single Value Matching, an "R" indicates Range Matching, an "*" indicates wildcard matching, and a 'U' indicates Universal Matching. "UNIQUE" indicates that this is the Unique Key for that query level, in which case Universal Matching or Single Value Matching is used depending on the query level.

4.2.7.3.1.4 SOP Specific Conformance for Q/R Move SOP Classes

The Q/R SCU AE provides standard conformance to the Query/Retrieve Move SOP Classes as an SCU.

The behavior of the Q/R SCU AE when encountering status codes in a Q/R C-MOVE response is summarized in the Table below:

Table 4.2-66
THE Q/R SCU AE C-MOVE RESPONSE STATUS BEHAVIOR

Service Status	Further Meaning	Status Code	Behavior
Success	Sub-operations complete – No Failures	0000	The Storage SCP AE has successfully received the SOP Instance. If all SOP Instances in a move job have status success then the job is marked as complete.
Refused	Out of Resources – Unable to calculate number of matches	A701H	The Association is aborted using A-ABORT and the move job is marked as failed. The status meaning is logged and the job failure is reported to the user via the job control application. This is a transient failure.
	Out of Resources – Unable to perform sub-operations	A702H	The Association is aborted using A-ABORT and the move job is marked as failed. The status meaning is logged and the job failure is reported to the user via the job control application.
	Move destination unknown	A801H	The Association is aborted using A-ABORT and the move job is marked as failed. The status meaning is logged and the job failure is reported to the user via the job control application.
Failed	Identifier does not match SOP Class	A900H	The Association is aborted using A-ABORT and the move job is marked as failed. The status meaning is logged and the job failure is reported to the user via the job control application.
Warning	Sub-operations complete but one or more failures.	B000H	The Association is aborted using A-ABORT and the move job is marked as failed. The status meaning is logged and the job failure is reported to the user via the job control application.

The behavior of the Q/R SCU AE during communication failure is summarized in the Table below.

Table 4.2-67
Q/R MOVE COMMUNICATION FAILURE BEHAVIOR

Exception	Behavior
Timeout	The Association is aborted using A-ABORT and the retrieve is marked as failed. The reason is logged and reported to the user.
Association aborted by the SCP or network layers	The retrieve is marked as failed. The reason is logged and reported to the user.

4.2.7.4 Association Acceptance Policy

The Q/R SCU AE does not accept Associations.

4.2.8 Storage SCP AE Specification

4.2.8.1 SOP Classes

The Storage SCP AE provides Standard Conformance to the following SOP Classes:

Table 4.2-68
SOP CLASSES FOR THE STORAGE SCU AE

SOP Class Name	SOP Class UID	SCU	SCP
Verification	1.2.840.10008.1.1	No	Yes
XA Image Storage	1.2.840.10008.5.1.4.1.1.12.1	No	Yes

4.2.8.2 Association Policies

4.2.8.2.1 General

The DICOM standard application context name for DICOM 3.0 is always proposed:

Table 4.2-69
DICOM APPLICATION CONTEXT FOR THE STORAGE SCP AE

Application Context Name	1.2.840.10008.3.1.1.1
--------------------------	-----------------------

4.2.8.2.2 Number of Associations

The Storage SCP AE can support up to three Associations at a time.

Table 4.2-70
NUMBER OF ASSOCIATIONS ACCEPTED FOR THE STORAGE SCP AE

Maximum number of simultaneous Associations	1
---	---

4.2.8.2.3 Asynchronous Nature

The Storage SCP AE does not support asynchronous communication (multiple outstanding transactions over a single Association).

Table 4.2-71
ASYNCHRONOUS NATURE FOR THE STORAGE SCP AE

Maximum number of outstanding asynchronous transactions	1
---	---

4.2.8.2.4 Implementation Identifying Information

The implementation information for the Storage SCP AE is:

Table 4.2-72
DICOM IMPLEMENTATION CLASS AND VERSION FOR THE STORAGE SCP AE

Implementation Class UID	1.2.392.200036.9116.7.8.12.10.31.1.1
Implementation Version Name	TM_INFUNIX_V2.0

4.2.8.3 Association Initiation Policy

The Storage SCP AE does not initiate Associations.

4.2.8.4 Association Acceptance Policy

The Storage SCP AE accepts Associations only if they have valid Presentation Contexts. If none of the requested Presentation Contexts are accepted then the Association Request itself is rejected. It can be configured to only accept Associations with certain hosts (using TCP/IP address) and/or Application Entity Titles.

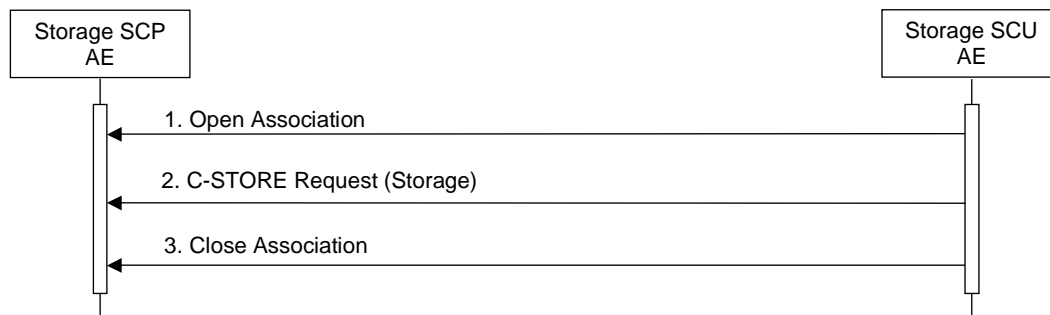

Figure 4.2-9
SEQUENCING OF ACTIVITY – STORE IMAGES TO THE LOCAL FILE SYSTEM

A possible sequence of interactions between the Storage SCP AE and a Storage SCU AE is illustrated in the Figure above:

1. The Storage SCU AE opens an Association with the Storage SCP AE.
2. The Storage SCU AE sends images to the Storage SCP AE using a Storage request (C-STORE) and the Storage SCP AE replies with a C-STORE response (status success).
3. The Storage SCU AE closes the Association with the Storage SCP AE.

The Storage SCP AE may reject Association attempts as shown in the Table below. The Result, Source and Reason/Diag columns represent the values returned in the corresponding fields of an ASSOCIATE-RJ PDU (see PS 3.8, Section 9.3.4). The following abbreviations are used in the Source column:

- 1 – DICOM UL service-user
- 2 – DICOM UL service-provider (ASCE related function)
- 3 – DICOM UL service-provider (Presentation related function)

**Table 4.2-73
ASSOCIATION REJECTION REASONS**

Result	Source	Reason/Diag	Explanation
2 – rejected-transient	c	2 – local-limit-exceeded	The (configurable) maximum number of simultaneous Associations has been reached. An Association request with the same parameters may succeed at a later time.
2 – rejected-transient	c	1 – temporary-congestion	No Associations can be accepted at this time due to the real-time requirements of higher priority activities (e.g. during image acquisition no Associations will be accepted) or because insufficient resources are available (e.g. memory, processes, threads). An Association request with the same parameters may succeed at a later time.
1 – rejected-permanent	a	2 – application-context-name-not-supported	The Association request contained an unsupported Application Context Name. An association request with the same parameters will not succeed at a later time.
1 – rejected-permanent	a	7 – called-AE-title-not-recognized	The Association request contained an unrecognized Called AE Title. An Association request with the same parameters will not succeed at a later time unless configuration changes are made. This rejection reason normally occurs when the Association initiator is incorrectly configured and attempts to address the Association acceptor using the wrong AE Title.
1 – rejected-permanent	a	3 – calling-AE-title-not-recognized	The Association request contained an unrecognized Calling AE Title. An Association request with the same parameters will not succeed at a later time unless configuration changes are made. This rejection reason normally occurs when the Association acceptor has not been configured to recognize the AE Title of the Association initiator.
1 – rejected-permanent	b	1 – no-reason-given	The Association request could not be parsed. An Association request with the same format will not succeed at a later time.

4.2.8.4.1.1 Accepted Presentation Contexts

The default Behavior of the Storage SCP AE supports the Implicit VR Little Endian, Explicit VR Little Endian Transfer Syntaxes.

If the both Transfer Syntaxes are proposed per Presentation Context then the Storage SCP AE will select Implicit VR Little Endian Transfer Syntax.

Any of the Presentation Contexts shown in the following table are acceptable to the Storage SCP AE.

Table 4.2-74
ACCEPTED PRESENTATION CONTEXTS BY THE STORAGE SCP AE

Presentation Context Table					
Abstract Syntax		Transfer Syntax		Role	Ext. Neg.
Name	UID	Name	UID		
Verification	1.2.840.10008.1.1	Implicit VR Little Endian	1.2.840.10008.1.2	SCP	None
XA Image Storage	1.2.840.10008.5.1.4.1.1.12.1	Implicit VR Little Endian Explicit VR Little Endian JPEG Lossless (Process 14[Section Value1])	1.2.840.10008.1.2 1.2.840.10008.1.2.1 1.2.840.10008.1.2.4.70	SCP	None

4.2.8.4.1.2 SOP Specific Conformance for Verification SOP Class

The Storage SCP AE provides standard conformance to the Verification SOP Class as an SCP.

4.2.8.4.1.3 SOP Specific Conformance for Storage SOP Classes

The associated Activity with the Storage service is the storage of medical image data received over the network on a designated hard disk. The Storage SCP AE will return a failure status if it is unable to store the images on to the hard disk.

The Storage SCP AE is Level 0 conformant as a Storage SCP.

Table 4.2-75
THE STORAGE SCP AE C-STORE RESPONSE STATUS RETURN REASONS

Service Status	Further Meaning	Status Code	Reason
Success	Success	0000	The Composite SOP Instance was successfully received, verified, and stored in the system database.
Refused	Out of Resources	A700H	Indicates that there was not enough local resources.
Error	Data Set does not match SOP Class	A900H	Indicates that the Data Set does not encode a valid instance of the SOP Class specified.
	Cannot understand	C000H	Indicates that the Storage SCP AE cannot parse the Data Set into Elements.

4.2.9 Print SCU AE Specification

4.2.9.1 SOP Classes

The Print SCU AE provides Standard Conformance to the following Meta SOP Classes:

Table 4.2-76
META SOP CLASSES FOR THE PRINT SCU AE

SOP Class Name	SOP Class UID	SCU	SCP
Basic Grayscale Print Management Meta	1.2.840.10008.5.1.1.9	Yes	No

The above Meta SOP Classes are defined by the following set of supported SOP Classes:

Table 4.2-77
SOP CLASSES FOR THE PRINT SCU AE

SOP Class Name	SOP Class UID	SCU	SCP
Basic Film Session SOP Class	1.2.840.10008.5.1.1.1	Yes	No
Basic Film Box SOP Class	1.2.840.10008.5.1.1.2	Yes	No
Basic Grayscale Image Box SOP Class	1.2.840.10008.5.1.1.4	Yes	No
Printer SOP Class	1.2.840.10008.5.1.1.16	Yes	No
Print Job SOP Class	1.2.840.10008.5.1.1.14	Yes	No
Presentation LUT SOP Class	1.2.840.10008.5.1.1.23	No	No

4.2.9.2 Association Policies

4.2.9.2.1 General

The DICOM standard application context name for DICOM 3.0 is always proposed:

Table 4.2-78
DICOM APPLICATION CONTEXT FOR THE PRINT SCU AE

Application Context Name	1.2.840.10008.3.1.1.1
--------------------------	-----------------------

4.2.9.2.2 Number of Associations

The Print SCU AE can initiate up to two Associations at a time.

Table 4.2-79
NUMBER OF ASSOCIATIONS ACCEPTED FOR THE PRINT SCU AE

Maximum number of simultaneous Associations	1
---	---

4.2.9.2.3 Asynchronous Nature

The Print SCU AE does not support asynchronous communication (multiple outstanding transactions over a single Association).

Table 4.2-80
ASYNCHRONOUS NATURE FOR THE PRINT SCU AE

Maximum number of outstanding asynchronous transactions	1
---	---

4.2.9.2.4 Implementation Identifying Information

The implementation information for the Print SCU AE is:

**Table 4.2-81
DICOM IMPLEMENTATION CLASS AND VERSION FOR THE PRINT SCU AE**

Implementation Class UID	1.2.392.200036.9116.7.8.12.10.31.1.1
Implementation Version Name	TM_INFINIX_V2.0

4.2.9.3 Association Initiation Policy

4.2.9.3.1 Activity – Send Images & Print Management Information

4.2.9.3.1.1 Description and Sequencing of Activities

A user composes images onto film sheets and requests them to be sent to a specific hardcopy device. The user can select the desired film format and number of copies.

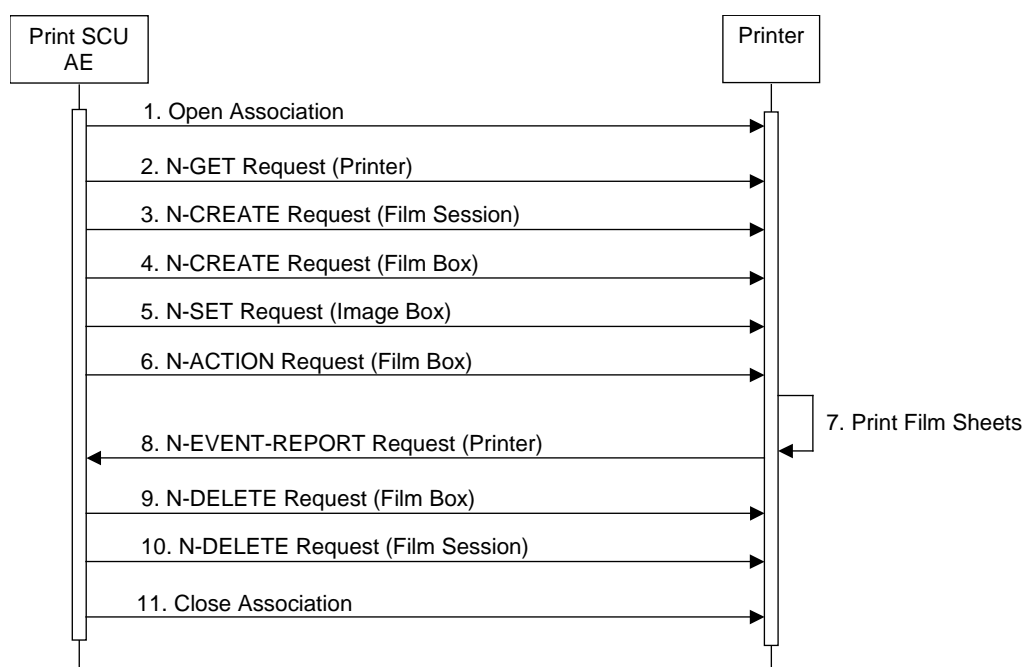

**Figure 4.2-10
SEQUENCING OF ACTIVITY – SEND IMAGES & PRINT MANAGEMENT INFORMATION**

A typical sequence of DIMSE messages sent over an association between the Print SCU AE and a Printer is illustrated in the Figure above:

1. The Print SCU AE opens an Association with the Printer.
2. N-GET on the Printer SOP Class is used to obtain current printer status information.
3. N-CREATE on the Film Session SOP Class creates a Film Session.
4. N-CREATE on the Film Box SOP Class creates a Film Box linked to the Film Session.
5. N-SET on the Image Box SOP Class transfers the contents of the film sheet to the printer.
6. N-ACTION on the Film Box SOP Class instructs the Printer to print the Film Box.
7. The Printer prints the requested number of film sheets.
8. The Printer asynchronously reports its status via N-EVENT-REPORT notification (Printer SOP Class). The printer can send this message at any time. The Print SCU AE does not require the N-EVENT-REPORT to be sent. The Print SCU AE is capable of receiving an N-EVENT-REPORT notification at any time during an association.
9. N-DELETE on the Film Box SOP Class deletes the complete Film Box SOP Instance hierarchy.
10. N-DELETE on the Film Session SOP Class deletes the complete Film Session SOP Instance hierarchy.
11. The Print SCU AE closes the Association with the Printer.

4.2.9.3.1.2 Proposed Presentation Contexts

The Print SCU AE is capable of proposing the Presentation Contexts shown in the Table below:

Table 4.2-82
PROPOSED PRESENTATION CONTEXTS FOR ACTIVITY
SEND IMAGES & PRINT MANAGEMENT INFORMATION

Presentation Context Table					
Abstract Syntax		Transfer Syntax		Role	Ext. Neg.
Name	UID	Name List	UID List		
Basic Grayscale Print Management Meta	1.2.840.10008.5.1. 1.9	Implicit VR Little Endian	1.2.840.10008.1.2	SCU	None
		Explicit VR Little Endian	1.2.840.10008.1.2.1		

4.2.9.3.1.3 Common SOP Specific Conformance for all Print SOP Classes

The general behavior of the Print SCU AE during communication failure is summarized in the Table below. This behavior is common for all SOP Classes supported by the Print SCU AE.

Table 4.2-83
PRINT COMMUNICATION FAILURE BEHAVIOR

Exception	Behavior
Timeout	The Association is aborted using A-ABORT and the print-job is marked as failed. The reason is logged and the job failure is reported to the user via the job control application.
Association aborted by the SCP or network layers	The print-job is marked as failed. The reason is logged and the job failure is reported to the user via the job control application.

4.2.9.3.1.4 SOP Specific Conformance for Printer SOP Class

The Print SCU AE supports the following DIMSE operations and notifications for the Printer SOP Class:

- N-GET
- N-EVENT-REPORT

Details of the supported attributes and status handling behavior are described in the following subsections.

4.2.9.3.1.4.1 Printer SOP Class Operations (N-GET)

The Print SCU AE uses the Printer SOP Class N-GET operation to obtain information about the current printer status. The attributes obtained via N-GET are listed in the Table below:

Table 4.2-84
PRINTER SOP CLASS N-GET REQUEST ATTRIBUTES

Attribute Name	Tag	VR	Value	Presence of Value	Source
Printer Status	(2110,0010)	CS	Provided by Printer	ALWAYS	Printer
Printer Status Info	(2110,0020)	CS	Provided by Printer	ALWAYS	Printer

The Printer Status information is evaluated as follows:

1. If Printer status (2110,0010) is NORMAL, the print-job continues to be printed.
2. If Printer status (2110,0010) is FAILURE, the print-job is marked as failed. The contents of Printer Status Info (2110,0020) is logged and reported to the user via the job control application.
3. If Printer status (2110,0010) is WARNING, the print-job continues to be printed. The contents of Printer Status Info (2110,0020) is logged and reported to the user via the job control application.
4. If Printer status (2110,0010) is empty, the print-job continues to be printed. The contents of Printer Status Info (2110,0020) is logged as NOT READY and reported to the user via the job control application.

The behavior of The Print SCU AE when encountering status codes in a N-GET response is summarized in the Table below:

Table 4.2-85
PRINTER SOP CLASS N-GET RESPONSE STATUS HANDLING BEHAVIOR

Service Status	Further Meaning	Status Code	Behavior
Success	Success	0000	The request to get printer status information was success.
*	*	Any other status code.	The Association is aborted using A-ABORT and the print-job is marked as failed. The status meaning is logged and reported to the user.

4.2.9.3.1.4.2 Printer SOP Class Notifications (N-EVENT-REPORT)

The Print SCU AE is capable of receiving an N-EVENT-REPORT request at any time during an association.

The behavior of The Print SCU AE when receiving Event Types within the N-EVENT-REPORT is summarized in the Table below:

Table 4.2-86
PRINTER SOP CLASS N-EVENT-REPORT BEHAVIOUR

Event Type Name	Event Type ID	Behavior
Normal	1	The print-job continues to be printed.
Warning	2	The print-job continues to be printed. The contents of Printer Status Info (2110,0020) is logged and reported to the user via the job-control application.
Failure	3	The print-job is marked as failed. The contents of Printer Status Info (2110,0020) is logged and reported to the user via the job-control application.
*	*	An invalid Event Type ID will cause a status code of 0113H to be returned in a N-EVENT-REPORT response.

The reasons for returning specific status codes in a N-EVENT-REPORT response are summarized in the Table below:

Table 4.2-87
PRINTER SOP CLASS N-EVENT-REPORT RESPONSE STATUS REASONS

Service Status	Further Meaning	Status Code	Reasons
Success	Success	0000	The notification event has been successfully received.
Failure	No Such Event Type	0113H	An invalid Event Type ID was supplied in the N-EVENT-REPORT request.
Failure	Processing Failure	0110H	An internal error occurred during processing of the N-EVENT-REPORT. A short description of the error will be returned in Error Comment (0000,0902).

4.2.9.3.1.5 SOP Specific Conformance for the Film Session SOP Class

The Print SCU AE supports the following DIMSE operations for the Film Session SOP Class:

- N-CREATE
- N-DELETE

Details of the supported attributes and status handling behavior are described in the following subsections.

4.2.9.3.1.5.1 Film Session SOP Class Operations (N-CREATE)

The attributes supplied in an N-CREATE Request are listed in the Table below:

Table 4.2-88
FILM SESSION SOP CLASS N-CREATE REQUEST ATTRIBUTES

Attribute Name	Tag	VR	Value	Presence of Value	Source
Number of Copies	(2000,0010)	IS	1 .. 99	ALWAYS	User
Medium Type	(2000,0030)	CS	BLUE FILM, CLEAR FILM or PAPER	ALWAYS	User
Film Destination	(2000,0040)	CS	MAGAZINE or PROCESSOR	ALWAYS	User

*:The behavior of The Print SCU AE when encountering status codes in a N-CREATE response is summarized in the Table below:

**Table 4.2-89
FILM SESSION SOP CLASS N-CREATE RESPONSE STATUS HANDLING BEHAVIOR**

Service Status	Further Meaning	Status Code	Behavior
Success	Success	0000	The SCP has completed the operation successfully.
Warning	Attribute Value Out of Range	0116H	The N-CREATE operation is considered successful if it is configured that the status would be considered successful.
Warning	Attribute List Error	0107H	The N-CREATE operation is considered successful if it is configured that the status would be considered successful.
*	*	Any other status code.	The Association is aborted using A-ABORT and the print-job is marked as failed. The status meaning is logged and reported to the user.

4.2.9.3.1.5.2 Film Session SOP Class Operations (N-DELETE)

The behavior of The Print SCU AE when encountering status codes in a N-DELETE response is summarized in the Table below:

**Table 4.2-90
PRINTER SOP CLASS N-DELETE RESPONSE STATUS HANDLING BEHAVIOR**

Service Status	Further Meaning	Status Code	Behavior
Success	Success	0000	The SCP has completed the operation successfully.
*	*	Any other status code.	The Association is aborted using A-ABORT and the print-job is marked as failed. The status meaning is logged and reported to the user.

4.2.9.3.1.6 SOP Specific Conformance for the Film Box SOP Class

The Print SCU AE supports the following DIMSE operations for the Film Box SOP Class:

- N-CREATE
- N-ACTION

Details of the supported attributes and status handling behavior are described in the following subsections.

4.2.9.3.1.6.1 Film Box SOP Class Operations (N-CREATE)

The attributes supplied in an N-CREATE Request are listed in the Table below:

**Table 4.2-91
FILM BOX SOP CLASS N-CREATE REQUEST ATTRIBUTES**

Attribute Name	Tag	VR	Value	Presence of Value	Source
Image Display Format	(2010,0010)	CS	STANDARD\1,1	ALWAYS	User
Referenced Film Session Sequence	(2010,0500)	SQ		ALWAYS	Auto
>Referenced SOP Class UID	(0008,1150)	UI	1.2.840.10008.5.1.1.2	ALWAYS	Auto
>Referenced SOP Instance UID	(0008,1155)	UI	From created Film Session SOP Instance	ALWAYS	Auto
Film Orientation	(2010,0040)	CS	PORTRAIT or LANDSCAPE	ALWAYS	User
Film Size ID	(2010,0050)	CS	14INX17IN, 14INX14IN, 11INX14IN, 11INX11IN, 8INX11IN, 8INX10IN, etc.	ALWAYS	User
Magnification Type	(2010,0060)	CS	REPLICATE, BILINEAR, CUBIC or NONE	ALWAYS	User
Border Density	(2010,0100)	CS	BLACK or WHITE	ALWAYS	User
Min Density	(2010,0120)	US	0 .. 9999	ALWAYS	User
Max Density	(2010,0130)	US	0 .. 9999	ALWAYS	User

The behavior of the Print SCU AE when encountering status codes in a N-CREATE response is summarized in the Table below:

**Table 4.2-92
FILM BOX SOP CLASS N-CREATE RESPONSE STATUS HANDLING BEHAVIOR**

Service Status	Further Meaning	Status Code	Behavior
Success	Success	0000	The SCP has completed the operation successfully.
Warning	Requested Min Density or Max Density outside of printer's operating range	B605H	The N-CREATE operation is considered successful if it is configured that the status would be considered successful.
*	*	Any other status code.	The Association is aborted using A-ABORT and the print-job is marked as failed. The status meaning is logged and reported to the user.

4.2.9.3.1.6.2 Film Box SOP Class Operations (N-ACTION)

An N-ACTION Request is issued to instruct the Print SCP to print the contents of the Film Box. The Action Reply argument in an N-ACTION response is not evaluated.

The behavior of The Print SCU AE when encountering status codes in a N-ACTION response is summarized in the Table below:

**Table 4.2-93
FILM BOX SOP CLASS N-ACTION RESPONSE STATUS HANDLING BEHAVIOR**

Service Status	Further Meaning	Status Code	Behavior
Success	Success	0000	The SCP has completed the operation successfully. The film has been accepted for printing.
Warning	Film Box SOP Instance hierarchy does not contain Image Box SOP Instances (empty page)	B603H	The N-ACTION operation is considered successful if it is configured that the status would be considered successful.
Warning	Image size is larger than Image Box size. The image has been demagnified.	B604H	The N-ACTION operation is considered successful if it is configured that the status would be considered successful.
Warning	Image size is larger than Image Box size. The image has been cropped to fit.	B609H	The N-ACTION operation is considered successful if it is configured that the status would be considered successful.
Warning	Image size or Combined Print Image Size is larger than Image Box size. The image or combined Print Image has been decimated to fit.	B60AH	The N-ACTION operation is considered successful if it is configured that the status would be considered successful.
Failure	Unable to create Print Job SOP Instance; print queue is full.	C602H	The Association is aborted using A-ABORT and the print-job is marked as failed. The status meaning is logged and reported to the user.
Failure	Image size is larger than Image Box size.	C603H	The Association is aborted using A-ABORT and the print-job is marked as failed. The status meaning is logged and reported to the user.
Failure	Combined Print Image Size is larger than Image Box size.	C613H	The Association is aborted using A-ABORT and the print-job is marked as failed. The status meaning is logged and reported to the user.
*	*	Any other status code.	The Association is aborted using A-ABORT and the print-job is marked as failed. The status meaning is logged and reported to the user.

4.2.9.3.1.7 SOP Specific Conformance for the Grayscale Image Box SOP Class

The Print SCU AE supports the following DIMSE operations for the Grayscale Image Box SOP Class:

— N-SET

Details of the supported attributes and status handling behavior are described in the following subsections.

4.2.9.3.1.7.1 Grayscale Image Box SOP Class Operations (N-SET)

The attributes supplied in an N-SET Request are listed in the Table below:

Table 4.2-94
GRAYSCALE IMAGE BOX SOP CLASS N-SET REQUEST ATTRIBUTES

Attribute Name	Tag	VR	Value	Presence of Value	Source
Image Position	(2020,0010)	US	1 .. 36	ALWAYS	Auto
Basic Grayscale Image Sequence	(2020,0110)	SQ		ALWAYS	Auto
>Samples Per Pixel	(0028,0002)	US	1	ALWAYS	Auto
>Photometric Interpretation	(0028,0004)	CS	MONOCHROME2	ALWAYS	Auto
>Rows	(0028,0010)	US		ALWAYS	Auto
>Columns	(0028,0011)	US		ALWAYS	Auto
>Pixel Aspect Ratio	(0028,0034)	IS	1\1	ALWAYS	Auto
>Bits Allocated	(0028,0100)	US	8	ALWAYS	Auto
>Bits Stored	(0028,0101)	US	8	ALWAYS	Auto
>High Bit	(0028,0102)	US	7	ALWAYS	Auto
>Pixel Representation	(0028,0103)	US	0	ALWAYS	Auto
>Pixel Data	(7FE0,0010)	OB		ALWAYS	Auto

The behavior of the Print SCU AE when encountering status codes in a N-SET response is summarized in the Table below:

**Table 4.2-95
GRAYSCALE IMAGE BOX SOP CLASS N-SET RESPONSE STATUS HANDLING BEHAVIOR**

Service Status	Further Meaning	Status Code	Behavior
Success	Success	0000	The SCP has completed the operation successfully. Image successfully stored in Image Box.
Warning	Image size is larger than Image Box size. The image has been demagnified.	B604H	The N-SET operation is considered successful if it is configured that the status would be considered successful.
Warning	Requested Min Density or Max Density outside of printer's operating range.	B605H	The N-SET operation is considered successful if it is configured that the status would be considered successful.
Warning	Image size is larger than Image Box size. The image has been cropped to fit.	B609H	The N-SET operation is considered successful if it is configured that the status would be considered successful.
Warning	Image size or Combined Print Image Size is larger than Image Box size. The image or combined Print Image has been decimated to fit.	B60AH	The N-SET operation is considered successful if it is configured that the status would be considered successful.
Failure	Image size is larger than Image Box size.	C603H	The Association is aborted using A-ABORT and the print-job is marked as failed. The status meaning is logged and reported to the user.
Failure	Insufficient memory in printer to store the image.	C605H	The Association is aborted using A-ABORT and the print-job is marked as failed. The status meaning is logged and reported to the user.
Failure	Combined Print Image Size is larger than Image Box size.	C613H	The Association is aborted using A-ABORT and the print-job is marked as failed. The status meaning is logged and reported to the user.
*	*	Any other status code.	The Association is aborted using A-ABORT and the print-job is marked as failed. The status meaning is logged and reported to the user.

4.2.9.4 Association Acceptance Policy

The Print SCU AE does not accept Associations.

4.3 NETWORK INTERFACES

4.3.1 Physical Network Interface

This Product supports a single network interface. One of the following physical network interfaces will be available depending on installed hardware options:

**Table 4.3-1
SUPPORTED PHYSICAL NETWORK INTERFACES**

Ethernet 1000baseT
Ethernet 100baseT
Ethernet 10baseT

4.3.2 Additional Protocols

None.

4.4 CONFIGURATION

4.4.1 AE Title/Presentation Address Mapping

4.4.1.1 Local AE Titles

All local applications use the AE Titles and TCP/IP Ports configured via the Service/Installation Tool. The Field Service Engineer can configure the TCP Port via the Service/Installation Tool.

**Table 4.4-1
AE TITLE CONFIGURATION TABLE**

Application Entity	Default AE Title	Default TCP/IP Port
Verification SCP	DICOM_LOCAL_SCP	104
Storage Commitment SCU		
Storage SCP		
Verification SCU	VERIFY_AETITLE	Not Applicable
MWM SCU	MWMSCU_AE	
MPPS SCU	MPPSSCU_AE	
Print SCU	PrintSCU_AE	
Query/Retrieve SCU	DICOM_LOCAL_SCU	
Storage SCU		

4.4.1.2 Remote AE Title/Presentation Address Mapping

The AE Titles, host names and port numbers of remote applications are configured using the Service/Installation Tool.

4.4.2 Parameters

A large number of parameters related to acquisition and general operation can be configured using the Service/Installation Tool. The Table below only shows those configuration parameters relevant to DICOM communication. See the Product's Service Manual for details on general configuration capabilities.

**Table 4.4-2
CONFIGURATION PARAMETERS TABLE**

Parameter	Configurable (Yes/No) [Range]	Default Value
General Parameters		
Max PDU Receive Size	Yes	28 KBytes
Max PDU Send Size	[4KB-512KB]	
Time-out waiting for a acceptance or rejection response to an Association Request (Application Level Timeout)	Yes [1-999999]	60 Sec
Time-out waiting for a response to an Association release request (Application Level Timeout)	Yes [1-999999]	60 sec
Time-out waiting for completion of a TCP/IP connect request (Low-level timeout)	Yes [1-999999]	60 sec
Time-out awaiting a Response to a DIMSE Request (Low-Level Timeout)	Yes [1-999999]	15 sec
Time-out for waiting for data between TCP/IP-packets (Low Level Timeout)	Yes [1-999999]	60 sec
Storage SCU Parameters		
Storage SCU time-out waiting for a response to a C-STORE-RQ	Yes [1-999999]	180sec
Number of times a failed send job may be retried	No	Forever, until the job succeeds or user deletes the job.
Delay between retrying failed send jobs	No	60sec
Maximum number of simultaneously initiated Associations by the Storage SCU AE	Yes	10
Supported Transfer Syntaxes (separately configurable for each remote AE)	No	Implicit VR Little Endian
Behavior when receiving the Warning "Coercion of Data Elements" as service status.	Yes [Considered as Success or Failure]	Considered as Failure
Behavior when receiving the Warning "Data Set does not match SOP Class" as service status.	Yes [Considered as Success or Failure]	Considered as Failure
Behavior when receiving the Warning "Elements Discarded" as service status.	Yes [Considered as Success or Failure]	Considered as Failure
Storage Commitment SCU Parameters		

Parameter	Configurable (Yes/No) [Range]	Default Value
Storage Commitment SCU time-out waiting for a response to a N-ACTION-RQ	Yes [1-999999]	30 Sec
Maximum number of simultaneously initiated Associations by the Storage Commitment SCU AE	No	1
Timeout waiting for a Storage Commitment Notification (maximum duration of applicability for a Storage Commitment Transaction UID).	No	Forever
Maximum number of simultaneously accepted Associations by the Storage Commitment SCU AE	No	1
Delay association release after sending a Storage Commitment Request (wait for a Storage Commitment Notification over the same association).	No	0
Behavior when receiving N-EVENT Report - the Storage Commitment Request Successful.	Yes	Permit the operator (s) to delete the Instances
Modality Worklist SCU Parameters		
Modality Worklist SCU time-out waiting for the final response to a C-FIND-RQ	Yes [1-999999]	180sec
Maximum number of simultaneously initiated Associations by the MWM SCU AE	No	1
MPPS SCU Parameters		
MPPS SCU time-out waiting for a response to a N-CREATE-RQ	Yes [1-999999]	180sec
MPPS SCU time-out waiting for a response to a N-SET-RQ	Yes [1-999999]	180sec
MPPS SCU time-out waiting for a response to a N-GET-RQ	Yes [1-999999]	180sec
Maximum number of simultaneously initiated Associations by the MPPS SCU AE	No	1
Supported Transfer Syntaxes for MPPS	Yes	Implicit VR Little Endian
Behavior when receiving the Warning "Attribute Value Out of Range" as service status.	Yes [Considered as Success or Failure]	Considered as Failure
Storage SCP parameters		
Maximum number of simultaneously accepted Associations by the Storage SCP AE	No	1
Print SCU Parameters		
Print SCU time-out waiting for a response to a N-GET-RQ	Yes [1-999999]	180sec
Print SCU time-out waiting for a response to a N-CREATE-RQ	Yes [1-999999]	180sec
Print SCU time-out waiting for a response to a N-SET-RQ	Yes [1-999999]	180sec

Parameter	Configurable (Yes/No) [Range]	Default Value
Print SCU time-out waiting for a response to a N-ACTION-RQ	Yes [1-999999]	180sec
Maximum number of simultaneously initiated Associations by the Print SCU AE	No	1
Supported Transfer Syntaxes (separately configurable for each remote printer)	Yes	Implicit VR Little Endian
Behavior when receiving the Warning "Attribute Value Out of Range" as service status of the Film Session N-CREATE.	Yes [Considered as Success or Failure]	Considered as Failure
Behavior when receiving the Warning "Attribute List Error" as service status of the Film Session N-CREATE.	Yes [Considered as Success or Failure]	Considered as Failure
Behavior when receiving the Warning "Requested Min Density or Max Density outside of printer's operating range" as service status of the Film Box N-CREATE.	Yes [Considered as Success or Failure]	Considered as Failure
Behavior when receiving the Warning "Film Box SOP Instance hierarchy does not contain Image Box SOP Instances (empty page)" as service status of the Film Box N-ACTION.	Yes [Considered as Success or Failure]	Considered as Failure
Behavior when receiving the Warning "Image size is larger than Image Box size. The image has been demagnified." as service status of the Film Box N-ACTION.	Yes [Considered as Success or Failure]	Considered as Failure
Behavior when receiving the Warning "Image size is larger than Image Box size. The image has been cropped to fit." as service status of the Film Box N-ACTION.	Yes [Considered as Success or Failure]	Considered as Failure
Behavior when receiving the Warning "Image size or Combined Print Image Size is larger than Image Box size. The image or combined Print Image has been decimated to fit." as service status of the Film Box N-ACTION.	Yes [Considered as Success or Failure]	Considered as Failure
Behavior when receiving the Warning "Image size is larger than Image Box size. The image has been demagnified." as service status of the Grayscale Image Box N-SET.	Yes [Considered as Success or Failure]	Considered as Failure
Behavior when receiving the Warning "Requested Min Density or Max Density outside of printer's operating range." as service status of the Grayscale Image Box N-SET.	Yes [Considered as Success or Failure]	Considered as Failure
Behavior when receiving the Warning "Image size is larger than Image Box size. The image has been cropped to fit." as service status of the Grayscale Image Box N-SET.	Yes [Considered as Success or Failure]	Considered as Failure

Parameter	Configurable (Yes/No) [Range]	Default Value
Behavior when receiving the Warning “Image size or Combined Print Image Size is larger than Image Box size. The image or combined Print Image has been decimated to fit.” as service status of the Grayscale Image Box N-SET.	Yes [Considered as Success or Failure]	Considered as Failure

5. MEDIA INTERCHANGE

5.1 IMPLEMENTATION MODEL

5.1.1 Application Data Flow

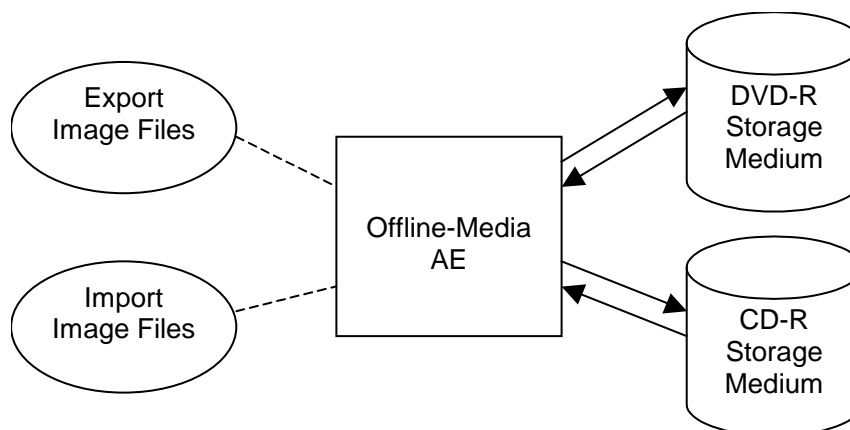

Figure 5.1-1
APPLICATION DATA FLOW DIAGRAM FOR MEDIA STORAGE

- The Offline-Media AE exports image files to a CD-R or a DVD-R Storage medium. It is associated with the local real-world activity “Export Image Files” performed upon user request.
- The Offline-Media AE imports image files from a CD-R or a DVD-R Storage medium. It is associated with the local real-world activity “Import Image Files” performed upon user request.

5.1.2 Functional Definition of AEs

5.1.2.1 Functional Definition of Offline-Media AE

The Offline-Media AE is performed upon user request for selected studies /series/images to/from an offline DICOM CD-R or DVD-R medium. It therefore performs the following tasks:

Export:

- Builds DICOM Information Objects.
- Creates a DICOMDIR file that represents the contents of the DICOM Information Objects to be recorded.
- Records DICOM Information Objects and the DICOMDIR file to the CD-R or the DVD-R medium.

Import:

- Reads the DICOMDIR file that represents the contents of the data as recorded.
- Displays the ordered list of studies/series/images, identifying information.
- Loads the selected studies/series/images from a CD-R or a DVD-R medium and displays them on the screen.

Note: The Offline-Media AE can update files created by the product itself.

5.1.3 Sequencing of Real-World Activities

5.1.3.1 Activity - Export Image Files

5.1.3.1.1 Activity-Export Image Files to CD-R

Operator requests to create new File-set(s) onto a new CD-R. The requests are placed in a queue and are executed in the background.

The operations for “Export Image Files” are described below:

- Step-1: Select the instance(s), series or studies on the local storage device to be created to the CD-R medium.
- Step-2: Select the image archiving.
- Step-3: Select the Virtual CD device as a destination.
- Step-4: Request to copy to the CD-R.

5.1.3.1.2 Activity-Export Image Files to DVD-R

Operator requests to create File-set(s) onto a new DVD-R. The requests are placed in a queue and are executed in the background.

The operations for “Export Image Files” are described below:

- Step-1: Select the instance(s), series or studies on the local storage device to be created to the DVD-R medium.
- Step-2: Select the image archiving.
- Step-3: Select the DVD device as a destination.
- Step-4: Request to copy to the DVD-R.

5.1.3.2 Activity - Import Image Files

Operator requests to retrieve File-set(s) on the CD-R or the DVD-R. The requests are placed in a queue and are executed in the background.

The operations for “Import Image Files” are described below:

- Step-1: Select the XA image(s), series or studies on the medium to be retrieved to the local storage device.
- Step-2: Select the data retrieval.
- Step-3: Select the local storage device as a destination.

5.1.4 File Meta Information for Implementation Class and Version

The implementation information written to the File Meta Header in each file is:

**Table 5.1-1
DICOM IMPLEMENTATION CLASS AND VERSION FOR MEDIA STORAGE**

File Meta Information Version	1
Implementation Class UID	1.2.392.200036.9116.7.8.12.10.31.1.1
Implementation Version Name	TM_INFINIX_V2.0

5.2 AE SPECIFICATIONS

5.2.1 Offline-Media AE Specification

The Offline-Media AE provides standard conformance to the DICOM Interchange Option of the Media Storage Service Class. The Application Profiles and roles are listed below:

**Table 5.2-1
APPLICATION PROFILES, ACTIVITIES AND ROLES FOR OFFLINE-MEDIA**

Application Profiles Supported	Real World Activity	Role	SC Option
Basic Cardiac X-ray Angiographic Studies on CD-R media: STD-XABC-CD	Export Image Files	FSC	Interchange
Extended Cardiac X-ray Angiographic Studies on CD-R media: AUG-XABC-CD			
Basic Cardiac X-ray Angiographic Studies on CD-R media: STD-XABC-CD	Import Image Files	FSR	Interchange
Extended Cardiac X-ray Angiographic Studies on CD-R media: AUG-XABC-CD			

In case of DVD-R medium, the Application Profiles described above are provisionally adopted.

5.2.1.1 File Meta Information for the Application Entity

The Offline-Media AE does not set the Source Application Entity Title.

5.2.1.2 Real-World Activities

5.2.1.2.1 Activity – Export Image Files

The Offline-Media AE acts as an FSC using the interchange option when requested to export SOP Instances from the local database to a CD-R or a DVD-R medium.

5.2.1.2.1.1 Media Storage Application Profiles

The Offline-Media AE supports the STD-XABC-CD and the AUG-XABC-CD Application Profile.

5.2.1.2.1.1.1 Options

The Offline-Media AE supports the SOP Classes and Transfer Syntaxes listed in the Table below for the STD-XABC-CD, the AUG-XABC-CD Application Profile as an FSC.

Table 5.2-2

IODS, SOP CLASSES AND TRANSFER SYNTAXES FOR THE STD-XABC-CD AND THE AUG-XABC-CD PROFILE

Information Object Definition	SOP Class UID	Transfer Syntax	Transfer Syntax UID
XA Image Storage	1.2.840.10008.5.1.4.1.1.12.1	Explicit VR Little Endian Uncompressed	1.2.840.10008.1.2.1
		Jpeg Lossless	1.2.840.10008.1.2.4.70

5.2.1.2.2 Activity – Import Image Files

The Offline-Media AE acts as an FSR using the interchange option when requested to import SOP Instances from a CD-R or a DVD-R medium to the local database.

5.2.1.2.2.1 Media Storage Application Profiles

The Offline-Media AE supports the STD-XABC-CD and the AUG-XABC-CD Application Profile.

5.2.1.2.2.1.1 Options

The Offline-Media AE supports the SOP Classes and Transfer Syntaxes listed in the Table below for the STD-XABC-CD and the AUG-XABC-CD Application Profile as an FSR.

Table 5.2-3

IODS, SOP CLASSES AND TRANSFER SYNTAXES FOR THE STD-XABC-CD AND THE AUG-XABC-CD PROFILE (FSR)

Information Object Definition	SOP Class UID	Transfer Syntax	Transfer Syntax UID
XA Image Storage	1.2.840.10008.5.1.4.1.1.12.1	Explicit VR Little Endian Uncompressed	1.2.840.10008.1.2.1
		Jpeg Lossless	1.2.840.10008.1.2.4.70

5.3 MEDIA CONFIGURATION

Not applicable to the Offline-Media AE.

7. SECURITY

This product does not support any specific security measures.

It is assumed that the product is used within a secured environment. It is assumed that a secured environment includes at a minimum:

- a. Firewall or router protections to ensure that only approved external hosts have network access to the product.
- b. Firewall or router protections to ensure that the product only has network access to approved external hosts and services.
- c. Any communication with external hosts and services outside the locally secured environment use appropriate secure network channels (e.g. such as a Virtual Private Network (VPN))

Other network security procedures such as automated intrusion detection may be appropriate in some environments. Additional security features may be established by the local security policy and are beyond the scope of this conformance statement.

8. ANNEXES

8.1 IOD CONTENTS

8.1.1 Created SOP Instances

Table 8.1-1 specifies the attributes of a XA Image transmitted by the Storage SCU AE.

The following tables use a number of abbreviations. The abbreviations used in the “Presence of ...” column are:

VNAP	Value Not Always Present (attribute sent zero length if no value is present)
ANAP	Attribute Not Always Present
ALWAYS	Always Present
EMPTY	Attribute is sent without a value

The abbreviations used in the “Source” column:

MWL	the attribute value source Modality Worklist
USER	the attribute value source is from User input
AUTO	the attribute value is generated automatically
MPPS	the attribute value is the same as that use for Modality Performed Procedure Step
CONFIG	the attribute value source is a configurable parameter

8.1.1.1 XA Image IOD

**Table 8.1-1
IOD OF CREATED XA IMAGE SOP INSTANCES**

IE	Module	Reference	Presence of Module
Patient	Patient	Table 8.1-5	ALWAYS
Study	General Study	Table 8.1-6	ALWAYS
	Patient Study	Table 8.1-7	ALWAYS
Series	General Series	Table 8.1-8	ALWAYS
Equipment	General Equipment	Table 8.1-9	ALWAYS
Image	General Image	Table 8.1-10	ALWAYS
	Image Pixel	Table 8.1-11	ALWAYS
	Contrast/Bolus	Table 8.1-12	Only if contrast media was used in this image
	Cine	Table 8.1-13	Only if DSA acquisition is performed
	Multi-frame	Table 8.1-14	ALWAYS
	Frame Pointers	Table 8.1-15	ALWAYS
	Display Shutter	Table 8.1-16	Only if shutter was used in this image
	Device	Table 8.1-17	Only if device data was used in this image
	Image Plane	Table 8.1-25	ALWAYS
	X-ray Image	Table 8.1-18	ALWAYS
	X-ray Acquisition	Table 8.1-19	ALWAYS
	X-ray Table	Table 8.1-20	ALWAYS
	X-ray Positioner	Table 8.1-21	ALWAYS
Curve	Table 8.1-22	Only if curve data was used in this image	

	VOI LUT	Table 8.1-23	ALWAYS
	SOP Common	Table 8.1-24	ALWAYS

8.1.1.2 DOSE SR IOD

**Table 8.1-2
IOD OF CREATED DOSE SR SOP INSTANCES**

IE	Module	Reference	Presence of Module
Patient	Patient	Table 8.1-5	ALWAYS
Study	General Study	Table 8.1-6	ALWAYS
	Patient Study	Table 8.1-7	ALWAYS
Series	General Series	Table 8.1-8	ALWAYS
Equipment	General Equipment	Table 8.1-9	ALWAYS
Document	SR Document General	Table 8.1-3	ALWAYS
	SR Document Content	Table 8.1-4	ALWAYS
	SOP Common	Table 8.1-24	ALWAYS

8.1.1.3 DOSE SR Modules

Table 8.1-3
SR DOCUMENT GENERAL MODULE OF CREATED SR SOP INSTANCES

Attribute Name	Tag	VR	Value	Presence of Value	Source
Image Number	(0020,0013)	IS	Generated by device	ALWAYS	AUTO
Content Date	(0008,0023)	DA	<yyyymmdd>	ALWAYS	AUTO
Content Time	(0008,0033)	TM	<hhmmss>	ALWAYS	AUTO
Instance Creation Date	(0008,0012)	DA	<yyyymmdd>	ALWAYS	AUTO
Instance Creation Time	(0008,0013)	TM		ALWAYS	AUTO
Instance Creator UID	(0008,0014)	UI		ALWAYS	AUTO
Performed Procedure Code Sequence	(0040,A372)	SQ		ALWAYS	AUTO
Completion Flag	(0040,A491)	CS	PARTIAL	ALWAYS	AUTO
Verification Flag	(0040,A493)	CS	UNVERIFIED	ALWAYS	AUTO
Content Template Sequence	(0040, A504)	SQ		ALWAYS	AUTO
>Mapping Resource	(0008, 0105)	CS	DCMR	ALWAYS	AUTO
>Template Identifier	(0040, DB00)	CS	10001	ALWAYS	AUTO

Table 8.1-4
SR DOCUMENT CONTENT MODULE OF CREATED SR SOP INSTANCES

Attribute Name	Tag	VR	Value			Presence of Value	Source
Value Type	(0040,A040)	CS	CONTAINER			ALWAYS	AUTO
Concept Name Code Sequence	(0040,A043)	SQ				ALWAYS	AUTO
>Code Value	(0008,0100)	SH	113701			ALWAYS	AUTO
>Coding Scheme Designator	(0008,0102)	SH	DCM			ALWAYS	AUTO
>Code Meaning	(0008,0104)	LO	X-Ray Radiation Dose Report			ALWAYS	AUTO
Continuity Of Content	(0040,A050)	CS	SEPARATE			ALWAYS	AUTO
Content Sequence	(0040,A730)	SQ				ALWAYS	AUTO
>Relationship Type	(0040,A010)	CS	HAS CONCEPT MOD			ALWAYS	AUTO
>Value Type	(0040,A040)	CS	CODE			ALWAYS	AUTO
>Concept Name Code Sequence	(0040,A043)	SQ				ALWAYS	AUTO
>>Code Value	(0008,0100)	SH	121058			ALWAYS	AUTO
>>Coding Scheme Designator	(0008,0102)	SH	DCM			ALWAYS	AUTO
>>Code Meaning	(0008,0104)	LO	Procedure reported			ALWAYS	AUTO
>Concept Code Sequence	(0040,A168)	SQ				ALWAYS	AUTO
>>Code Value	(0008,0100)	SH	113704			ALWAYS	AUTO
>>Coding Scheme Designator	(0008,0102)	SH	DCM			ALWAYS	AUTO
>>Code Meaning	(0008,0104)	LO	Projection X-Ray			ALWAYS	AUTO
>Relationship Type	(0040,A010)	CS	HAS CONCEPT MOD			ALWAYS	AUTO
>Value Type	(0040,A040)	CS	CODE			ALWAYS	AUTO
>Concept Name Code Sequence	(0040,A043)	SQ				ALWAYS	AUTO
>>Code Value	(0008,0100)	SH	G-C0E8			ALWAYS	AUTO
>>Coding Scheme Designator	(0008,0102)	SH	SRT			ALWAYS	AUTO
>>Code Meaning	(0008,0104)	LO	Has Intent			ALWAYS	AUTO
>Concept Code Sequence	(0040,A168)	SQ				ALWAYS	AUTO
>>Code Value	(0008,0100)	SH	CV	CSD	CM	ALWAYS	AUTO
>>Coding Scheme Designator	(0008,0102)	SH	R-408C3	SRT	Diagnostic Intent	ALWAYS	AUTO
>>Code Meaning	(0008,0104)	LO	R-41531	SRT	Therapeutic Intent	ALWAYS	AUTO
			R-002E9	SRT	Combined Diagnostic and Therapeutic Procedure		

Attribute Name	Tag	VR	Value	Presence of Value	Source
>Relationship Type	(0040,A010)	CS	HAS CONCEPT MOD	ALWAYS	AUTO
>Value Type	(0040,A040)	CS	CODE	ALWAYS	AUTO
>Concept Name Code Sequence	(0040,A043)	SQ		ALWAYS	AUTO
>>Code Value	(0008,0100)	SH	121005	ALWAYS	AUTO
>>Coding Scheme Designator	(0008,0102)	SH	DCM	ALWAYS	AUTO
>>Code Meaning	(0008,0104)	LO	Observer Type	ALWAYS	AUTO
>Concept Code Sequence	(0040,A168)	SQ		ALWAYS	AUTO
>>Code Value	(0008,0100)	SH	121007	ALWAYS	AUTO
>>Coding Scheme Designator	(0008,0102)	SH	DCM	ALWAYS	AUTO
>>Code Meaning	(0008,0104)	LO	Device	ALWAYS	AUTO
>Relationship Type	(0040,A010)	CS	HAS CONCEPT MOD	ALWAYS	AUTO
>Value Type	(0040,A040)	CS	UIDREF	ALWAYS	AUTO
>Concept Name Code Sequence	(0040,A043)	SQ		ALWAYS	AUTO
>>Code Value	(0008,0100)	SH	121012	ALWAYS	AUTO
>>Coding Scheme Designator	(0008,0102)	SH	DCM	ALWAYS	AUTO
>>Code Meaning	(0008,0104)	LO	Device Observer UID	ALWAYS	AUTO
>UID	(0040,A124)	UI	1.2.392.200036.9116.3.1+Device Serial Number	ALWAYS	AUTO
>Relationship Type	(0040,A010)	CS	HAS CONCEPT MOD	ALWAYS	AUTO
>Value Type	(0040,A040)	CS	TEXT	ALWAYS	AUTO
>Concept Name Code Sequence	(0040,A043)	SQ		ALWAYS	AUTO
>>Code Value	(0008,0100)	SH	121014	ALWAYS	AUTO
>>Coding Scheme Designator	(0008,0102)	SH	DCM	ALWAYS	AUTO
>>Code Meaning	(0008,0104)	LO	Device Observer Manufacturer	ALWAYS	AUTO
>Text Value	(0040,A160)	UT	TOSHIBA_MEC	ALWAYS	AUTO
>Relationship Type	(0040,A010)	CS	HAS CONCEPT MOD	ALWAYS	AUTO
>Value Type	(0040,A040)	CS	TEXT	ALWAYS	AUTO
>Concept Name Code Sequence	(0040,A043)	SQ		ALWAYS	AUTO
>>Code Value	(0008,0100)	SH	121015	ALWAYS	AUTO
>>Coding Scheme Designator	(0008,0102)	SH	DCM	ALWAYS	AUTO
>>Code Meaning	(0008,0104)	LO	Device Observer Model Name	ALWAYS	AUTO
>Text Value	(0040,A160)	UT	DFP-8000D	ALWAYS	AUTO
>Relationship Type	(0040,A010)	CS	HAS CONCEPT MOD	ALWAYS	AUTO
>Value Type	(0040,A040)	CS	TEXT	ALWAYS	AUTO

Attribute Name	Tag	VR	Value	Presence of Value	Source
>Concept Name Code Sequence	(0040,A043)	SQ		ALWAYS	AUTO
>>Code Value	(0008,0100)	SH	121016	ALWAYS	AUTO
>>Coding Scheme Designator	(0008,0102)	SH	DCM	ALWAYS	AUTO
>>Code Meaning	(0008,0104)	LO	Device Observer Serial Number	ALWAYS	AUTO
>Text Value	(0040,A160)	UT	Same as (0018,1000) Device Serial Number	ALWAYS	AUTO
>Relationship Type	(0040,A010)	CS	HAS CONCEPT MOD	ALWAYS	AUTO
>Value Type	(0040,A040)	CS	CODE	ALWAYS	AUTO
>Concept Name Code Sequence	(0040,A043)	SQ		ALWAYS	AUTO
>>Code Value	(0008,0100)	SH	113705	ALWAYS	AUTO
>>Coding Scheme Designator	(0008,0102)	SH	DCM	ALWAYS	AUTO
>>Code Meaning	(0008,0104)	LO	Scope of Accumulation	ALWAYS	AUTO
>Concept Code Sequence	(0040,A168)	SQ		ALWAYS	AUTO
>>Code Value	(0008,0100)	SH	113014	ALWAYS	AUTO
>>Coding Scheme Designator	(0008,0102)	SH	DCM	ALWAYS	AUTO
>>Code Meaning	(0008,0104)	LO	Study	ALWAYS	AUTO
>Relationship Type	(0040,A010)	CS	HAS CONCEPT MOD	ALWAYS	AUTO
>Value Type	(0040,A040)	CS	UIDREF	ALWAYS	AUTO
>Concept Name Code Sequence	(0040,A043)	SQ		ALWAYS	AUTO
>>Code Value	(0008,0100)	SH	110180	ALWAYS	AUTO
>>Coding Scheme Designator	(0008,0102)	SH	DCM	ALWAYS	AUTO
>>Code Meaning	(0008,0104)	LO	Study Instance UID	ALWAYS	AUTO
>UID	(0040,A124)	UI		ALWAYS	AUTO
>Relationship Type	(0040,A010)	CS	CONTAINS	ALWAYS	AUTO
>Value Type	(0040,A040)	CS	CONTAINER	ALWAYS	AUTO
>Concept Name Code Sequence	(0040,A043)	SQ		ALWAYS	AUTO
>>Code Value	(0008,0100)	SH	113702	ALWAYS	AUTO
>>Coding Scheme Designator	(0008,0102)	SH	DCM	ALWAYS	AUTO
>>Code Meaning	(0008,0104)	LO	Accumulated X-Ray Dose Data	ALWAYS	AUTO
>Continuity Of Content	(0040,A050)	CS	SEPARATE	ALWAYS	AUTO
>Content Sequence	(0040,A730)	SQ		ALWAYS	AUTO
>>Relationship Type	(0040,A010)	CS	HAS CONCEPT MOD	ALWAYS	AUTO
>>Value Type	(0040,A040)	CS	CODE	ALWAYS	AUTO

Attribute Name	Tag	VR	Value	Presence of Value	Source		
>>Concept Name Code Sequence	(0040,A043)	SQ		ALWAYS	AUTO		
>>>Code Value	(0008,0100)	SH	113764	ALWAYS	AUTO		
>>>Coding Scheme Designator	(0008,0102)	SH	DCM	ALWAYS	AUTO		
>>>Code Meaning	(0008,0104)	LO	Acquisition Plane	ALWAYS	AUTO		
>>Concept Code Sequence	(0040,A168)	SQ		ALWAYS	AUTO		
>>>Code Value	(0008,0100)	SH	113620	ALWAYS	AUTO		
>>>Coding Scheme Designator	(0008,0102)	SH	DCM	ALWAYS	AUTO		
>>>Code Meaning	(0008,0104)	LO	CV	CSD	CM	ALWAYS	AUTO
			113620	DCM	Plane A		
			113621	DCM	Plane B		
			113622	DCM	Single Plane		
>>Relationship Type	(0040,A010)	CS	CONTAINS	ALWAYS	AUTO		
>>Value Type	(0040,A040)	CS	NUM	ALWAYS	AUTO		
>>Concept Name Code Sequence	(0040,A043)	SQ		ALWAYS	AUTO		
>>>Code Value	(0008,0100)	SH	113722	ALWAYS	AUTO		
>>>Coding Scheme Designator	(0008,0102)	SH	DCM	ALWAYS	AUTO		
>>>Code Meaning	(0008,0104)	LO	Dose Area Product Total	ALWAYS	AUTO		
>>Measured Value Sequence	(0040,A300)	SQ		ALWAYS	AUTO		
>>Measurement Units Code Sequence	(0040,08EA)	SQ		ALWAYS	AUTO		
>>>Code Value	(0008,0100)	SH	Gy.m2	ALWAYS	AUTO		
>>>Coding Scheme Designator	(0008,0102)	SH	UCUM	ALWAYS	AUTO		
>>>Code Meaning	(0008,0104)	LO	Gy.m2	ALWAYS	AUTO		
>>Numeric Value	(0040,A30A)	DS		ALWAYS	AUTO		
>>Relationship Type	(0040,A010)	CS	CONTAINS	ALWAYS	AUTO		
>>Value Type	(0040,A040)	CS	NUM	ALWAYS	AUTO		
>>Concept Name Code Sequence	(0040,A043)	SQ		ALWAYS	AUTO		
>>>Code Value	(0008,0100)	SH	113725	ALWAYS	AUTO		
>>>Coding Scheme Designator	(0008,0102)	SH	DCM	ALWAYS	AUTO		
>>>Code Meaning	(0008,0104)	LO	Dose (RP) Total	ALWAYS	AUTO		
>>Measured Value Sequence	(0040,A300)	SQ		ALWAYS	AUTO		
>>Measurement Units Code Sequence	(0040,08EA)	SQ		ALWAYS	AUTO		
>>>Code Value	(0008,0100)	SH	Gy	ALWAYS	AUTO		

Attribute Name	Tag	VR	Value	Presence of Value	Source
>>>Coding Scheme Designator	(0008,0102)	SH	UCUM	ALWAYS	AUTO
>>>Code Meaning	(0008,0104)	LO	Gy	ALWAYS	AUTO
>>Numeric Value	(0040,A30A)	DS		ALWAYS	AUTO
>>Relationship Type	(0040,A010)	CS	CONTAINS	ALWAYS	AUTO
>>Value Type	(0040,A040)	CS	NUM	ALWAYS	AUTO
>>Concept Name Code Sequence	(0040,A043)	SQ		ALWAYS	AUTO
>>>Code Value	(0008,0100)	SH	113726	ALWAYS	AUTO
>>>Coding Scheme Designator	(0008,0102)	SH	DCM	ALWAYS	AUTO
>>>Code Meaning	(0008,0104)	LO	Fluoro Dose Area Product Total	ALWAYS	AUTO
>>Measured Value Sequence	(0040,A300)	SQ		ALWAYS	AUTO
>>Measurement Units Code Sequence	(0040,08EA)	SQ		ALWAYS	AUTO
>>>Code Value	(0008,0100)	SH	Gy.m2	ALWAYS	AUTO
>>>Coding Scheme Designator	(0008,0102)	SH	UCUM	ALWAYS	AUTO
>>>Code Meaning	(0008,0104)	LO	Gy.m2	ALWAYS	AUTO
>>Numeric Value	(0040,A30A)	DS		ALWAYS	AUTO
>>Relationship Type	(0040,A010)	CS	CONTAINS	ALWAYS	AUTO
>>Value Type	(0040,A040)	CS	NUM	ALWAYS	AUTO
>>Concept Name Code Sequence	(0040,A043)	SQ		ALWAYS	AUTO
>>>Code Value	(0008,0100)	SH	113728	ALWAYS	AUTO
>>>Coding Scheme Designator	(0008,0102)	SH	DCM	ALWAYS	AUTO
>>>Code Meaning	(0008,0104)	LO	Fluoro Dose (RP) Total	ALWAYS	AUTO
>>Measured Value Sequence	(0040,A300)	SQ		ALWAYS	AUTO
>>Measurement Units Code Sequence	(0040,08EA)	SQ		ALWAYS	AUTO
>>>Code Value	(0008,0100)	SH	Gy	ALWAYS	AUTO
>>>Coding Scheme Designator	(0008,0102)	SH	UCUM	ALWAYS	AUTO
>>>Code Meaning	(0008,0104)	LO	Gy	ALWAYS	AUTO
>>Numeric Value	(0040,A30A)	DS		ALWAYS	AUTO
>>Relationship Type	(0040,A010)	CS	CONTAINS	ALWAYS	AUTO
>>Value Type	(0040,A040)	CS	NUM	ALWAYS	AUTO
>>Concept Name Code Sequence	(0040,A043)	SQ		ALWAYS	AUTO
>>>Code Value	(0008,0100)	SH	113730	ALWAYS	AUTO
>>>Coding Scheme Designator	(0008,0102)	SH	DCM	ALWAYS	AUTO

Attribute Name	Tag	VR	Value	Presence of Value	Source
>>>Code Meaning	(0008,0104)	LO	Total Fluoro Time	ALWAYS	AUTO
>>Measured Value Sequence	(0040,A300)	SQ		ALWAYS	AUTO
>>Measurement Units Code Sequence	(0040,08EA)	SQ		ALWAYS	AUTO
>>>Code Value	(0008,0100)	SH	s	ALWAYS	AUTO
>>>Coding Scheme Designator	(0008,0102)	SH	UCUM	ALWAYS	AUTO
>>>Code Meaning	(0008,0104)	LO	s	ALWAYS	AUTO
>>Numeric Value	(0040,A30A)	DS		ALWAYS	AUTO
>>Relationship Type	(0040,A010)	CS	CONTAINS	ALWAYS	AUTO
>>Value Type	(0040,A040)	CS	NUM	ALWAYS	AUTO
>>Concept Name Code Sequence	(0040,A043)	SQ		ALWAYS	AUTO
>>>Code Value	(0008,0100)	SH	113727	ALWAYS	AUTO
>>>Coding Scheme Designator	(0008,0102)	SH	DCM	ALWAYS	AUTO
>>>Code Meaning	(0008,0104)	LO	Acquisition Dose Area Product Total	ALWAYS	AUTO
>>Measured Value Sequence	(0040,A300)	SQ		ALWAYS	AUTO
>>Measurement Units Code Sequence	(0040,08EA)	SQ		ALWAYS	AUTO
>>>Code Value	(0008,0100)	SH	Gy.m2	ALWAYS	AUTO
>>>Coding Scheme Designator	(0008,0102)	SH	UCUM	ALWAYS	AUTO
>>>Code Meaning	(0008,0104)	LO	Gy.m2	ALWAYS	AUTO
>>Numeric Value	(0040,A30A)	DS		ALWAYS	AUTO
>>Relationship Type	(0040,A010)	CS	CONTAINS	ALWAYS	AUTO
>>Value Type	(0040,A040)	CS	NUM	ALWAYS	AUTO
>>Concept Name Code Sequence	(0040,A043)	SQ		ALWAYS	AUTO
>>>Code Value	(0008,0100)	SH	113729	ALWAYS	AUTO
>>>Coding Scheme Designator	(0008,0102)	SH	DCM	ALWAYS	AUTO
>>>Code Meaning	(0008,0104)	LO	Acquisition Dose (RP) Total	ALWAYS	AUTO
>>Measured Value Sequence	(0040,A300)	SQ		ALWAYS	AUTO
>>Measurement Units Code Sequence	(0040,08EA)	SQ		ALWAYS	AUTO
>>>Code Value	(0008,0100)	SH	Gy	ALWAYS	AUTO
>>>Coding Scheme Designator	(0008,0102)	SH	UCUM	ALWAYS	AUTO
>>>Code Meaning	(0008,0104)	LO	Gy	ALWAYS	AUTO
>>Numeric Value	(0040,A30A)	DS		ALWAYS	AUTO
>>Relationship Type	(0040,A010)	CS	CONTAINS	ALWAYS	AUTO

Attribute Name	Tag	VR	Value	Presence of Value	Source						
>>Value Type	(0040,A040)	CS	NUM	ALWAYS	AUTO						
>>Concept Name Code Sequence	(0040,A043)	SQ		ALWAYS	AUTO						
>>>Code Value	(0008,0100)	SH	113855	ALWAYS	AUTO						
>>>Coding Scheme Designator	(0008,0102)	SH	DCM	ALWAYS	AUTO						
>>>Code Meaning	(0008,0104)	LO	Total Acquisition Time	ALWAYS	AUTO						
>>Measured Value Sequence	(0040,A300)	SQ		ALWAYS	AUTO						
>>Measurement Units Code Sequence	(0040,08EA)	SQ		ALWAYS	AUTO						
>>>Code Value	(0008,0100)	SH	s	ALWAYS	AUTO						
>>>Coding Scheme Designator	(0008,0102)	SH	UCUM	ALWAYS	AUTO						
>>>Code Meaning	(0008,0104)	LO	s	ALWAYS	AUTO						
>>Numeric Value	(0040,A30A)	DS		ALWAYS	AUTO						
>>Relationship Type	(0040,A010)	CS	CONTAINS	ALWAYS	AUTO						
>>Value Type	(0040,A040)	CS	TEXT	ALWAYS	AUTO						
>>Concept Name Code Sequence	(0040,A043)	SQ		ALWAYS	AUTO						
>>>Code Value	(0008,0100)	SH	113780	ALWAYS	AUTO						
>>>Coding Scheme Designator	(0008,0102)	SH	DCM	ALWAYS	AUTO						
>>>Code Meaning	(0008,0104)	LO	Reference Point Definition	ALWAYS	AUTO						
>>Text Value	(0040,A160)	UT	<p>If option is enabled,</p> <table border="1"> <thead> <tr> <th>CV</th> <th>CSD</th> <th>CM</th> </tr> </thead> <tbody> <tr> <td>113860</td> <td>DCM</td> <td>15cm from Isocenter toward Source</td> </tr> </tbody> </table> <p>If option is disabled, Text is set. ("5cm from 10cm above Tabletop toward Source/5cm from Isocenter toward Source /5cm from 10cm above Tabletop toward Source (PA)")</p>	CV	CSD	CM	113860	DCM	15cm from Isocenter toward Source	ALWAYS	AUTO
CV	CSD	CM									
113860	DCM	15cm from Isocenter toward Source									
>Relationship Type	(0040,A010)	CS	CONTAINS	ALWAYS	AUTO						
>Value Type	(0040,A040)	CS	CONTAINER	ALWAYS	AUTO						
>Concept Name Code Sequence	(0040,A043)	SQ		ALWAYS	AUTO						
>>Code Value	(0008,0100)	SH	113706	ALWAYS	AUTO						
>>Coding Scheme Designator	(0008,0102)	SH	DCM	ALWAYS	AUTO						
>>Code Meaning	(0008,0104)	LO	Irradiation Event X-Ray Data	ALWAYS	AUTO						
>Continuity Of Content	(0040,A050)	CS	SEPARATE	ALWAYS	AUTO						
>Content Sequence	(0040,A730)	SQ		ALWAYS	AUTO						

Attribute Name	Tag	VR	Value	Presence of Value	Source															
>>Relationship Type	(0040,A010)	CS	HAS CONCEPT MOD	ALWAYS	AUTO															
>>Value Type	(0040,A040)	CS	CODE	ALWAYS	AUTO															
>>Concept Name Code Sequence	(0040,A043)	SQ		ALWAYS	AUTO															
>>>Code Value	(0008,0100)	SH	113764	ALWAYS	AUTO															
>>>Coding Scheme Designator	(0008,0102)	SH	DCM	ALWAYS	AUTO															
>>>Code Meaning	(0008,0104)	LO	Acquisition Plane	ALWAYS	AUTO															
>>Concept Code Sequence	(0040,A168)	SQ		ALWAYS	AUTO															
>>>Code Value	(0008,0100)	SH	113620	ALWAYS	AUTO															
>>>Coding Scheme Designator	(0008,0102)	SH	DCM	ALWAYS	AUTO															
>>>Code Meaning	(0008,0104)	LO	<table border="1"> <thead> <tr> <th>CV</th> <th>CSD</th> <th>CM</th> </tr> </thead> <tbody> <tr> <td>113620</td> <td>DCM</td> <td>Plane A</td> </tr> <tr> <td>113621</td> <td>DCM</td> <td>Plane B</td> </tr> <tr> <td>113622</td> <td>DCM</td> <td>Single Plane</td> </tr> </tbody> </table>	CV	CSD	CM	113620	DCM	Plane A	113621	DCM	Plane B	113622	DCM	Single Plane	ALWAYS	AUTO			
CV	CSD	CM																		
113620	DCM	Plane A																		
113621	DCM	Plane B																		
113622	DCM	Single Plane																		
>>Relationship Type	(0040,A010)	CS	HAS CONCEPT MOD	ALWAYS	AUTO															
>>Value Type	(0040,A040)	CS	DATETIME	ALWAYS	AUTO															
>>Concept Name Code Sequence	(0040,A043)	SQ		ALWAYS	AUTO															
>>>Code Value	(0008,0100)	SH	111526	ALWAYS	AUTO															
>>>Coding Scheme Designator	(0008,0102)	SH	DCM	ALWAYS	AUTO															
>>>Code Meaning	(0008,0104)	LO	DateTime Started	ALWAYS	AUTO															
>>DateTime	(0040,A120)	DT	<yyyymmddhhmmss>	ALWAYS	AUTO															
>>Relationship Type	(0040,A010)	CS	CONTAINS	ALWAYS	AUTO															
>>Value Type	(0040,A040)	CS	CODE	ALWAYS	AUTO															
>>Concept Name Code Sequence	(0040,A043)	SQ		ALWAYS	AUTO															
>>>Code Value	(0008,0100)	SH	113721	ALWAYS	AUTO															
>>>Coding Scheme Designator	(0008,0102)	SH	DCM	ALWAYS	AUTO															
>>>Code Meaning	(0008,0104)	LO	Irradiation Event Type	ALWAYS	AUTO															
>>Concept Code Sequence	(0040,A168)	SQ		ALWAYS	AUTO															
>>>Code Value	(0008,0100)	SH	<table border="1"> <thead> <tr> <th>CV</th> <th>CSD</th> <th>CM</th> </tr> </thead> <tbody> <tr> <td>P5-06000</td> <td>SRT</td> <td>Fluoroscopy</td> </tr> <tr> <td>113611</td> <td>DCM</td> <td>Stationary Acquisition</td> </tr> <tr> <td>113612</td> <td>DCM</td> <td>Stepping Acquisition</td> </tr> <tr> <td>113613</td> <td>DCM</td> <td>Rotational Acquisition</td> </tr> </tbody> </table>	CV	CSD	CM	P5-06000	SRT	Fluoroscopy	113611	DCM	Stationary Acquisition	113612	DCM	Stepping Acquisition	113613	DCM	Rotational Acquisition	ALWAYS	AUTO
CV	CSD	CM																		
P5-06000	SRT	Fluoroscopy																		
113611	DCM	Stationary Acquisition																		
113612	DCM	Stepping Acquisition																		
113613	DCM	Rotational Acquisition																		
>>>Coding Scheme Designator	(0008,0102)	SH		ALWAYS	AUTO															
>>>Code Meaning	(0008,0104)	LO		ALWAYS	AUTO															

Attribute Name	Tag	VR	Value	Presence of Value	Source						
>>Relationship Type	(0040,A010)	CS	CONTAINS	ALWAYS	AUTO						
>>Value Type	(0040,A040)	CS	TEXT	ALWAYS	AUTO						
>>Concept Name Code Sequence	(0040,A043)	SQ		ALWAYS	AUTO						
>>>Code Value	(0008,0100)	SH	113780	ALWAYS	AUTO						
>>>Coding Scheme Designator	(0008,0102)	SH	DCM	ALWAYS	AUTO						
>>>Code Meaning	(0008,0104)	LO	Reference Point Definition	ALWAYS	AUTO						
>>Text Value	(0040,A160)	UT	<p>If option is enabled,</p> <table border="1"> <thead> <tr> <th>CV</th> <th>CSD</th> <th>CM</th> </tr> </thead> <tbody> <tr> <td>113860</td> <td>DCM</td> <td>15cm from Isocenter toward Source</td> </tr> </tbody> </table> <p>If option is disabled, Text is set. ("5cm from 10cm above Tabletop toward Source/5cm from Isocenter toward Source /5cm from 10cm above Tabletop toward Source (PA)")</p>	CV	CSD	CM	113860	DCM	15cm from Isocenter toward Source	ALWAYS	AUTO
CV	CSD	CM									
113860	DCM	15cm from Isocenter toward Source									
>>Relationship Type	(0040,A010)	CS	CONTAINS	ALWAYS	AUTO						
>>Value Type	(0040,A040)	CS	UIDREF	ALWAYS	AUTO						
>>Concept Name Code Sequence	(0040,A043)	SQ		ALWAYS	AUTO						
>>>Code Value	(0008,0100)	SH	113769	ALWAYS	AUTO						
>>>Coding Scheme Designator	(0008,0102)	SH	DCM	ALWAYS	AUTO						
>>>Code Meaning	(0008,0104)	LO	Irradiation Event UID	ALWAYS	AUTO						
>>UID	(0040,A124)	UI	<p>Fluoroscopy: StudyInstanceUID<.>1<.>Create Time(hhmmss):</p> <p>Radiography: StudyInstanceUID<.>0<.>Create Time(hhmmss)</p>	ALWAYS	AUTO						
>>Relationship Type	(0040,A010)	CS	CONTAINS	ALWAYS	AUTO						
>>Value Type	(0040,A040)	CS	NUM	ALWAYS	AUTO						
>>Concept Name Code Sequence	(0040,A043)	SQ		ALWAYS	AUTO						
>>>Code Value	(0008,0100)	SH	122130	ALWAYS	AUTO						
>>>Coding Scheme Designator	(0008,0102)	SH	DCM	ALWAYS	AUTO						
>>>Code Meaning	(0008,0104)	LO	Dose Area Product	ALWAYS	AUTO						
>>Measured Value Sequence	(0040,A300)	SQ		ALWAYS	AUTO						
>>Measurement Units Code Sequence	(0040,08EA)	SQ		ALWAYS	AUTO						

Attribute Name	Tag	VR	Value	Presence of Value	Source
>>>Code Value	(0008,0100)	SH	Gy.m2	ALWAYS	AUTO
>>>Coding Scheme Designator	(0008,0102)	SH	UCUM	ALWAYS	AUTO
>>>Code Meaning	(0008,0104)	LO	Gy.m2	ALWAYS	AUTO
>>Numeric Value	(0040,A30A)	DS		ALWAYS	AUTO
>>Relationship Type	(0040,A010)	CS	CONTAINS	ALWAYS	AUTO
>>Value Type	(0040,A040)	CS	NUM	ALWAYS	AUTO
>>Concept Name Code Sequence	(0040,A043)	SQ		ALWAYS	AUTO
>>>Code Value	(0008,0100)	SH	113738	ALWAYS	AUTO
>>>Coding Scheme Designator	(0008,0102)	SH	DCM	ALWAYS	AUTO
>>>Code Meaning	(0008,0104)	LO	Dose (RP)	ALWAYS	AUTO
>>Measured Value Sequence	(0040,A300)	SQ		ALWAYS	AUTO
>>Measurement Units Code Sequence	(0040,08EA)	SQ		ALWAYS	AUTO
>>>Code Value	(0008,0100)	SH	Gy	ALWAYS	AUTO
>>>Coding Scheme Designator	(0008,0102)	SH	UCUM	ALWAYS	AUTO
>>>Code Meaning	(0008,0104)	LO	Gy	ALWAYS	AUTO
>>Numeric Value	(0040,A30A)	DS		ALWAYS	AUTO
>>Relationship Type	(0040,A010)	CS	CONTAINS	ALWAYS	AUTO
>>Value Type	(0040,A040)	CS	NUM	ALWAYS	AUTO
>>Concept Name Code Sequence	(0040,A043)	SQ		ALWAYS	AUTO
>>>Code Value	(0008,0100)	SH	112011	ALWAYS	AUTO
>>>Coding Scheme Designator	(0008,0102)	SH	DCM	ALWAYS	AUTO
>>>Code Meaning	(0008,0104)	LO	Positioner Primary Angle	ALWAYS	AUTO
>>Measured Value Sequence	(0040,A300)	SQ		ALWAYS	AUTO
>>Measurement Units Code Sequence	(0040,08EA)	SQ		ALWAYS	AUTO
>>>Code Value	(0008,0100)	SH	deg	ALWAYS	AUTO
>>>Coding Scheme Designator	(0008,0102)	SH	UCUM	ALWAYS	AUTO
>>>Code Meaning	(0008,0104)	LO	O	ALWAYS	AUTO
>>Numeric Value	(0040,A30A)	DS		ALWAYS	AUTO
>>Relationship Type	(0040,A010)	CS	CONTAINS	ALWAYS	AUTO
>>Value Type	(0040,A040)	CS	NUM	ALWAYS	AUTO
>>Concept Name Code Sequence	(0040,A043)	SQ		ALWAYS	AUTO
>>>Code Value	(0008,0100)	SH	112012	ALWAYS	AUTO

Attribute Name	Tag	VR	Value	Presence of Value	Source
>>>Coding Scheme Designator	(0008,0102)	SH	DCM	ALWAYS	AUTO
>>>Code Meaning	(0008,0104)	LO	Positioner Secondary Angle	ALWAYS	AUTO
>>Measured Value Sequence	(0040,A300)	SQ		ALWAYS	AUTO
>>Measurement Units Code Sequence	(0040,08EA)	SQ		ALWAYS	AUTO
>>>Code Value	(0008,0100)	SH	deg	ALWAYS	AUTO
>>>Coding Scheme Designator	(0008,0102)	SH	UCUM	ALWAYS	AUTO
>>>Code Meaning	(0008,0104)	LO	o	ALWAYS	AUTO
>>Numeric Value	(0040,A30A)	DS		ALWAYS	AUTO
>>Relationship Type	(0040,A010)	CS	CONTAINS	ANAP	AUTO
>>Value Type	(0040,A040)	CS	NUM	ANAP	AUTO
>>Concept Name Code Sequence	(0040,A043)	SQ		ANAP	AUTO
>>>Code Value	(0008,0100)	SH	113739	ANAP	AUTO
>>>Coding Scheme Designator	(0008,0102)	SH	DCM	ANAP	AUTO
>>>Code Meaning	(0008,0104)	LO	Positioner Primary End Angle	ANAP	AUTO
>>Measured Value Sequence	(0040,A300)	SQ		ANAP	AUTO
>>Measurement Units Code Sequence	(0040,08EA)	SQ		ANAP	AUTO
>>>Code Value	(0008,0100)	SH	deg	ANAP	AUTO
>>>Coding Scheme Designator	(0008,0102)	SH	UCUM	ANAP	AUTO
>>>Code Meaning	(0008,0104)	LO	O	ANAP	AUTO
>>Numeric Value	(0040,A30A)	DS		ANAP	AUTO
>>Relationship Type	(0040,A010)	CS	CONTAINS	ANAP	AUTO
>>Value Type	(0040,A040)	CS	NUM	ANAP	AUTO
>>Concept Name Code Sequence	(0040,A043)	SQ		ANAP	AUTO
>>>Code Value	(0008,0100)	SH	113740	ANAP	AUTO
>>>Coding Scheme Designator	(0008,0102)	SH	DCM	ANAP	AUTO
>>>Code Meaning	(0008,0104)	LO	Positioner Secondary End Angle	ANAP	AUTO
>>Measured Value Sequence	(0040,A300)	SQ		ANAP	AUTO
>>Measurement Units Code Sequence	(0040,08EA)	SQ		ANAP	AUTO
>>>Code Value	(0008,0100)	SH	deg	ANAP	AUTO
>>>Coding Scheme Designator	(0008,0102)	SH	UCUM	ANAP	AUTO

Attribute Name	Tag	VR	Value	Presence of Value	Source
>>>Code Meaning	(0008,0104)	LO	o	ANAP	AUTO
>>Numeric Value	(0040,A30A)	DS		ANAP	AUTO
>>Relationship Type	(0040,A010)	CS	CONTAINS	ALWAYS	AUTO
>>Value Type	(0040,A040)	CS	NUM	ALWAYS	AUTO
>>Concept Name Code Sequence	(0040,A043)	SQ		ALWAYS	AUTO
>>>Code Value	(0008,0100)	SH	113790	ALWAYS	AUTO
>>>Coding Scheme Designator	(0008,0102)	SH	DCM	ALWAYS	AUTO
>>>Code Meaning	(0008,0104)	LO	Collimated Field Area	ALWAYS	AUTO
>>Measured Value Sequence	(0040,A300)	SQ		ALWAYS	AUTO
>>Measurement Units Code Sequence	(0040,08EA)	SQ		ALWAYS	AUTO
>>>Code Value	(0008,0100)	SH	m2	ALWAYS	AUTO
>>>Coding Scheme Designator	(0008,0102)	SH	UCUM	ALWAYS	AUTO
>>>Code Meaning	(0008,0104)	LO	m^2	ALWAYS	AUTO
>>Numeric Value	(0040,A30A)	DS		ALWAYS	AUTO
>>Relationship Type	(0040,A010)	CS	CONTAINS	ALWAYS	AUTO
>>Value Type	(0040,A040)	CS	CONTAINER	ALWAYS	AUTO
>>Concept Name Code Sequence	(0040,A043)	SQ		ALWAYS	AUTO
>>>Code Value	(0008,0100)	SH	113771	ALWAYS	AUTO
>>>Coding Scheme Designator	(0008,0102)	SH	DCM	ALWAYS	AUTO
>>>Code Meaning	(0008,0104)	LO	X-Ray Filters	ALWAYS	AUTO
>>Continuity Of Content	(0040,A050)	CS	SEPARATE	ALWAYS	AUTO
>>Content Sequence	(0040,A730)	SQ		ALWAYS	AUTO
>>>Relationship Type	(0040,A010)	CS	CONTAINS	ALWAYS	AUTO
>>>Value Type	(0040,A040)	CS	CODE	ALWAYS	AUTO
>>>Concept Name Code Sequence	(0040,A043)	SQ		ALWAYS	AUTO
>>>>Code Value	(0008,0100)	SH	113772	ALWAYS	AUTO
>>>>Coding Scheme Designator	(0008,0102)	SH	DCM	ALWAYS	AUTO
>>>>Code Meaning	(0008,0104)	LO	X-Ray Filters Type	ALWAYS	AUTO
>>>Concept Code Sequence	(0040,A168)	SQ		ALWAYS	AUTO
>>>>Code Value	(0008,0100)	SH	113650	ALWAYS	AUTO
>>>>Coding Scheme Designator	(0008,0102)	SH	DCM	ALWAYS	AUTO
>>>>Code Meaning	(0008,0104)	LO	Strip filter	ALWAYS	AUTO
>>>Relationship Type	(0040,A010)	CS	CONTAINS	ALWAYS	AUTO

Attribute Name	Tag	VR	Value	Presence of Value	Source			
>>>Value Type	(0040,A040)	CS	CODE	ALWAYS	AUTO			
>>>Concept Name Code Sequence	(0040,A043)	SQ		ALWAYS	AUTO			
>>>>Code Value	(0008,0100)	SH	113757	ALWAYS	AUTO			
>>>>Coding Scheme Designator	(0008,0102)	SH	DCM	ALWAYS	AUTO			
>>>>Code Meaning	(0008,0104)	LO	X-Ray Filters Material	ALWAYS	AUTO			
>>>Concept Code Sequence	(0040,A168)	SQ		ALWAYS	AUTO			
>>>>Code Value	(0008,0100)	SH	<table border="1"><thead><tr><th>CSD</th><th>CV</th><th>CM</th></tr></thead></table>	CSD	CV	CM	ALWAYS	AUTO
CSD	CV	CM						
>>>>Coding Scheme Designator	(0008,0102)	SH	SRT C-120F9 Aluminum or Aluminum compound	ALWAYS	AUTO			
>>>>Code Meaning	(0008,0104)	LO	SRT C-127F9 Copper or Copper compound	ALWAYS	AUTO			
			SRT C-156F9 Tantalum or Tantalum compound					
>>>Relationship Type	(0040,A010)	CS	CONTAINS	ALWAYS	AUTO			
>>>Value Type	(0040,A040)	CS	NUM	ALWAYS	AUTO			
>>>Concept Name Code Sequence	(0040,A043)	SQ		ALWAYS	AUTO			
>>>>Code Value	(0008,0100)	SH	113758	ALWAYS	AUTO			
>>>>Coding Scheme Designator	(0008,0102)	SH	DCM	ALWAYS	AUTO			
>>>>Code Meaning	(0008,0104)	LO	X-Ray Filter Thickness Minimum	ALWAYS	AUTO			
>>>Measured Value Sequence	(0040,A300)	SQ		ALWAYS	AUTO			
>>>Measurement Units Code Sequence	(0040,08EA)	SQ		ALWAYS	AUTO			
>>>>Code Value	(0008,0100)	SH	mm	ALWAYS	AUTO			
>>>>Coding Scheme Designator	(0008,0102)	SH	UCUM	ALWAYS	AUTO			
>>>>Code Meaning	(0008,0104)	LO	mm	ALWAYS	AUTO			
>>>Numeric Value	(0040,A30A)	DS		ALWAYS	AUTO			
>>>Relationship Type	(0040,A010)	CS	CONTAINS	ALWAYS	AUTO			
>>>Value Type	(0040,A040)	CS	NUM	ALWAYS	AUTO			
>>>Concept Name Code Sequence	(0040,A043)	SQ		ALWAYS	AUTO			
>>>>Code Value	(0008,0100)	SH	113773	ALWAYS	AUTO			
>>>>Coding Scheme Designator	(0008,0102)	SH	DCM	ALWAYS	AUTO			
>>>>Code Meaning	(0008,0104)	LO	X-Ray Filter Thickness Maximum	ALWAYS	AUTO			
>>>Measured Value Sequence	(0040,A300)	SQ		ALWAYS	AUTO			

Attribute Name	Tag	VR	Value	Presence of Value	Source									
>>>Measurement Units Code Sequence	(0040,08EA)	SQ		ALWAYS	AUTO									
>>>>Code Value	(0008,0100)	SH	mm	ALWAYS	AUTO									
>>>>Coding Scheme Designator	(0008,0102)	SH	UCUM	ALWAYS	AUTO									
>>>>Code Meaning	(0008,0104)	LO	mm	ALWAYS	AUTO									
>>>Numeric Value	(0040,A30A)	DS		ALWAYS	AUTO									
>>Relationship Type	(0040,A010)	CS	CONTAINS	ALWAYS	AUTO									
>>Value Type	(0040,A040)	CS	CODE	ALWAYS	AUTO									
>>Concept Name Code Sequence	(0040,A043)	SQ		ALWAYS	AUTO									
>>>Code Value	(0008,0100)	SH	113732	ALWAYS	AUTO									
>>>Coding Scheme Designator	(0008,0102)	SH	DCM	ALWAYS	AUTO									
>>>Code Meaning	(0008,0104)	LO	Fluoro Mode	ALWAYS	AUTO									
>>Concept Code Sequence	(0040,A168)	SQ		ALWAYS	AUTO									
>>>Code Value	(0008,0100)	SH	<table border="1"> <thead> <tr> <th>CV</th> <th>CSD</th> <th>CM</th> </tr> </thead> <tbody> <tr> <td>113630</td> <td>DCM</td> <td>Continuous</td> </tr> <tr> <td>113631</td> <td>DCM</td> <td>Pulsed</td> </tr> </tbody> </table>	CV	CSD	CM	113630	DCM	Continuous	113631	DCM	Pulsed	ALWAYS	AUTO
CV	CSD	CM												
113630	DCM	Continuous												
113631	DCM	Pulsed												
>>>>Coding Scheme Designator	(0008,0102)	SH		ALWAYS	AUTO									
>>>>Code Meaning	(0008,0104)	LO		ALWAYS	AUTO									
>>Relationship Type	(0040,A010)	CS	CONTAINS	ALWAYS	AUTO									
>>Value Type	(0040,A040)	CS	NUM	ALWAYS	AUTO									
>>Concept Name Code Sequence	(0040,A043)	SQ		ALWAYS	AUTO									
>>>Code Value	(0008,0100)	SH	113791	ALWAYS	AUTO									
>>>Coding Scheme Designator	(0008,0102)	SH	DCM	ALWAYS	AUTO									
>>>Code Meaning	(0008,0104)	LO	Pulse Rate	ALWAYS	AUTO									
>>Measured Value Sequence	(0040,A300)	SQ		ALWAYS	AUTO									
>>Measurement Units Code Sequence	(0040,08EA)	SQ		ALWAYS	AUTO									
>>>Code Value	(0008,0100)	SH	{pulse}/s	ALWAYS	AUTO									
>>>>Coding Scheme Designator	(0008,0102)	SH	UCUM	ALWAYS	AUTO									
>>>>Code Meaning	(0008,0104)	LO	pulse/s	ALWAYS	AUTO									
>>Numeric Value	(0040,A30A)	DS		ALWAYS	AUTO									
>>Relationship Type	(0040,A010)	CS	CONTAINS	ALWAYS	AUTO									
>>Value Type	(0040,A040)	CS	NUM	ALWAYS	AUTO									
>>Concept Name Code Sequence	(0040,A043)	SQ		ALWAYS	AUTO									
>>>Code Value	(0008,0100)	SH	113768	ALWAYS	AUTO									
>>>>Coding Scheme Designator	(0008,0102)	SH	DCM	ALWAYS	AUTO									

Attribute Name	Tag	VR	Value	Presence of Value	Source
>>>Code Meaning	(0008,0104)	LO	Number of Pulses	ALWAYS	AUTO
>>Measured Value Sequence	(0040,A300)	SQ		ALWAYS	AUTO
>>Measurement Units Code Sequence	(0040,08EA)	SQ		ALWAYS	AUTO
>>>Code Value	(0008,0100)	SH	1	ALWAYS	AUTO
>>>Coding Scheme Designator	(0008,0102)	SH	UCUM	ALWAYS	AUTO
>>>Code Meaning	(0008,0104)	LO	no units	ALWAYS	AUTO
>>Numeric Value	(0040,A30A)	DS		ALWAYS	AUTO
>>Relationship Type	(0040,A010)	CS	HAS CONCEPT MOD	ALWAYS	AUTO
>>Value Type	(0040,A040)	CS	CODE	ALWAYS	AUTO
>>Concept Name Code Sequence	(0040,A043)	SQ		ALWAYS	AUTO
>>>Code Value	(0008,0100)	SH	121401	ALWAYS	AUTO
>>>Coding Scheme Designator	(0008,0102)	SH	DCM	ALWAYS	AUTO
>>>Code Meaning	(0008,0104)	LO	Derivation	ALWAYS	AUTO
>>Concept Code Sequence	(0040,A168)	SQ		ALWAYS	AUTO
>>>Code Value	(0008,0100)	SH	R-10260	ALWAYS	AUTO
>>>Coding Scheme Designator	(0008,0102)	SH	SRT	ALWAYS	AUTO
>>>Code Meaning	(0008,0104)	LO	Estimated	ALWAYS	AUTO
>>Relationship Type	(0040,A010)	CS	CONTAINS	ALWAYS	AUTO
>>Value Type	(0040,A040)	CS	NUM	ALWAYS	AUTO
>>Concept Name Code Sequence	(0040,A043)	SQ		ALWAYS	AUTO
>>>Code Value	(0008,0100)	SH	113733	ALWAYS	AUTO
>>>Coding Scheme Designator	(0008,0102)	SH	DCM	ALWAYS	AUTO
>>>Code Meaning	(0008,0104)	LO	KVP	ALWAYS	AUTO
>>Measured Value Sequence	(0040,A300)	SQ		ALWAYS	AUTO
>>Measurement Units Code Sequence	(0040,08EA)	SQ		ALWAYS	AUTO
>>>Code Value	(0008,0100)	SH	kV	ALWAYS	AUTO
>>>Coding Scheme Designator	(0008,0102)	SH	UCUM	ALWAYS	AUTO
>>>Code Meaning	(0008,0104)	LO	kV	ALWAYS	AUTO
>>Numeric Value	(0040,A30A)	DS		ALWAYS	AUTO
>>Relationship Type	(0040,A010)	CS	CONTAINS	ALWAYS	AUTO
>>Value Type	(0040,A040)	CS	NUM	ALWAYS	AUTO
>>Concept Name Code Sequence	(0040,A043)	SQ		ALWAYS	AUTO

Attribute Name	Tag	VR	Value	Presence of Value	Source
>>>Code Value	(0008,0100)	SH	113734	ALWAYS	AUTO
>>>Coding Scheme Designator	(0008,0102)	SH	DCM	ALWAYS	AUTO
>>>Code Meaning	(0008,0104)	LO	X-Ray Tube Current	ALWAYS	AUTO
>>Measured Value Sequence	(0040,A300)	SQ		ALWAYS	AUTO
>>Measurement Units Code Sequence	(0040,08EA)	SQ		ALWAYS	AUTO
>>>Code Value	(0008,0100)	SH	mA	ALWAYS	AUTO
>>>Coding Scheme Designator	(0008,0102)	SH	UCUM	ALWAYS	AUTO
>>>Code Meaning	(0008,0104)	LO	mA	ALWAYS	AUTO
>>Numeric Value	(0040,A30A)	DS		ALWAYS	AUTO
>>Relationship Type	(0040,A010)	CS	CONTAINS	ALWAYS	AUTO
>>Value Type	(0040,A040)	CS	NUM	ALWAYS	AUTO
>>Concept Name Code Sequence	(0040,A043)	SQ		ALWAYS	AUTO
>>>Code Value	(0008,0100)	SH	113735	ALWAYS	AUTO
>>>Coding Scheme Designator	(0008,0102)	SH	DCM	ALWAYS	AUTO
>>>Code Meaning	(0008,0104)	LO	Exposure Time	ALWAYS	AUTO
>>Measured Value Sequence	(0040,A300)	SQ		ALWAYS	AUTO
>>Measurement Units Code Sequence	(0040,08EA)	SQ		ALWAYS	AUTO
>>>Code Value	(0008,0100)	SH	ms	ALWAYS	AUTO
>>>Coding Scheme Designator	(0008,0102)	SH	UCUM	ALWAYS	AUTO
>>>Code Meaning	(0008,0104)	LO	ms	ALWAYS	AUTO
>>Numeric Value	(0040,A30A)	DS		ALWAYS	AUTO
>>Relationship Type	(0040,A010)	CS	CONTAINS	ALWAYS	AUTO
>>Value Type	(0040,A040)	CS	NUM	ALWAYS	AUTO
>>Concept Name Code Sequence	(0040,A043)	SQ		ALWAYS	AUTO
>>>Code Value	(0008,0100)	SH	113793	ALWAYS	AUTO
>>>Coding Scheme Designator	(0008,0102)	SH	DCM	ALWAYS	AUTO
>>>Code Meaning	(0008,0104)	LO	Pulse Width	ALWAYS	AUTO
>>Measured Value Sequence	(0040,A300)	SQ		ALWAYS	AUTO
>>Measurement Units Code Sequence	(0040,08EA)	SQ		ALWAYS	AUTO
>>>Code Value	(0008,0100)	SH	ms	ALWAYS	AUTO
>>>Coding Scheme Designator	(0008,0102)	SH	UCUM	ALWAYS	AUTO

Attribute Name	Tag	VR	Value	Presence of Value	Source
>>>Code Meaning	(0008,0104)	LO	ms	ALWAYS	AUTO
>>Numeric Value	(0040,A30A)	DS		ALWAYS	AUTO
>>Relationship Type	(0040,A010)	CS	CONTAINS	ALWAYS	AUTO
>>Value Type	(0040,A040)	CS	NUM	ALWAYS	AUTO
>>Concept Name Code Sequence	(0040,A043)	SQ		ALWAYS	AUTO
>>>Code Value	(0008,0100)	SH	113766	ALWAYS	AUTO
>>>Coding Scheme Designator	(0008,0102)	SH	DCM	ALWAYS	AUTO
>>>Code Meaning	(0008,0104)	LO	Focal Spot Size	ALWAYS	AUTO
>>Measured Value Sequence	(0040,A300)	SQ		ALWAYS	AUTO
>>Measurement Units Code Sequence	(0040,08EA)	SQ		ALWAYS	AUTO
>>>Code Value	(0008,0100)	SH	mm	ALWAYS	AUTO
>>>Coding Scheme Designator	(0008,0102)	SH	UCUM	ALWAYS	AUTO
>>>Code Meaning	(0008,0104)	LO	mm	ALWAYS	AUTO
>>Numeric Value	(0040,A30A)	DS		ALWAYS	AUTO
>>Relationship Type	(0040,A010)	CS	CONTAINS	ALWAYS	AUTO
>>Value Type	(0040,A040)	CS	NUM	ALWAYS	AUTO
>>Concept Name Code Sequence	(0040,A043)	SQ		ALWAYS	AUTO
>>>Code Value	(0008,0100)	SH	113750	ALWAYS	AUTO
>>>Coding Scheme Designator	(0008,0102)	SH	DCM	ALWAYS	AUTO
>>>Code Meaning	(0008,0104)	LO	Distance Source to Detector	ALWAYS	AUTO
>>Measured Value Sequence	(0040,A300)	SQ		ALWAYS	AUTO
>>Measurement Units Code Sequence	(0040,08EA)	SQ		ALWAYS	AUTO
>>>Code Value	(0008,0100)	SH	mm	ALWAYS	AUTO
>>>Coding Scheme Designator	(0008,0102)	SH	UCUM	ALWAYS	AUTO
>>>Code Meaning	(0008,0104)	LO	mm	ALWAYS	AUTO
>>Numeric Value	(0040,A30A)	DS		ALWAYS	AUTO
>>Relationship Type	(0040,A010)	CS	CONTAINS	ALWAYS	AUTO
>>Value Type	(0040,A040)	CS	NUM	ALWAYS	AUTO
>>Concept Name Code Sequence	(0040,A043)	SQ		ALWAYS	AUTO
>>>Code Value	(0008,0100)	SH	113751	ALWAYS	AUTO
>>>Coding Scheme Designator	(0008,0102)	SH	DCM	ALWAYS	AUTO
>>>Code Meaning	(0008,0104)	LO	Table Longitudinal Position	ALWAYS	AUTO

Attribute Name	Tag	VR	Value	Presence of Value	Source
>>Measured Value Sequence	(0040,A300)	SQ		ALWAYS	AUTO
>>Measurement Units Code Sequence	(0040,08EA)	SQ		ALWAYS	AUTO
>>>Code Value	(0008,0100)	SH	mm	ALWAYS	AUTO
>>>Coding Scheme Designator	(0008,0102)	SH	UCUM	ALWAYS	AUTO
>>>Code Meaning	(0008,0104)	LO	mm	ALWAYS	AUTO
>>Numeric Value	(0040,A30A)	DS		ALWAYS	AUTO
>>>Code Value	(0008,0100)	SH	113752	ALWAYS	AUTO
>>>Coding Scheme Designator	(0008,0102)	SH	DCM	ALWAYS	AUTO
>>>Code Meaning	(0008,0104)	LO	Table Lateral Position	ALWAYS	AUTO
>>Measured Value Sequence	(0040,A300)	SQ		ALWAYS	AUTO
>>Measurement Units Code Sequence	(0040,08EA)	SQ		ALWAYS	AUTO
>>>Code Value	(0008,0100)	SH	mm	ALWAYS	AUTO
>>>Coding Scheme Designator	(0008,0102)	SH	UCUM	ALWAYS	AUTO
>>>Code Meaning	(0008,0104)	LO	mm	ALWAYS	AUTO
>>Numeric Value	(0040,A30A)	DS		ALWAYS	AUTO
>>Concept Name Code Sequence	(0040,A043)	SQ		ALWAYS	AUTO
>>>Code Value	(0008,0100)	SH	113753	ALWAYS	AUTO
>>>Coding Scheme Designator	(0008,0102)	SH	DCM	ALWAYS	AUTO
>>>Code Meaning	(0008,0104)	LO	Table Height Position	ALWAYS	AUTO
>>Measured Value Sequence	(0040,A300)	SQ		ALWAYS	AUTO
>>Measurement Units Code Sequence	(0040,08EA)	SQ		ALWAYS	AUTO
>>>Code Value	(0008,0100)	SH	mm	ALWAYS	AUTO
>>>Coding Scheme Designator	(0008,0102)	SH	UCUM	ALWAYS	AUTO
>>>Code Meaning	(0008,0104)	LO	mm	ALWAYS	AUTO
>>Numeric Value	(0040,A30A)	DS		ALWAYS	AUTO
>>Relationship Type	(0040,A010)	CS	CONTAINS	ALWAYS	AUTO
>>Value Type	(0040,A040)	CS	NUM	ALWAYS	AUTO
>>Concept Name Code Sequence	(0040,A043)	SQ		ALWAYS	AUTO
>>>Code Value	(0008,0100)	SH	113754	ALWAYS	AUTO
>>>Coding Scheme Designator	(0008,0102)	SH	DCM	ALWAYS	AUTO

Attribute Name	Tag	VR	Value	Presence of Value	Source
>>>Code Meaning	(0008,0104)	LO	Table Head Tilt Angle	ALWAYS	AUTO
>>Measured Value Sequence	(0040,A300)	SQ		ALWAYS	AUTO
>>Measurement Units Code Sequence	(0040,08EA)	SQ		ALWAYS	AUTO
>>>Code Value	(0008,0100)	SH	deg	ALWAYS	AUTO
>>>Coding Scheme Designator	(0008,0102)	SH	UCUM	ALWAYS	AUTO
>>>Code Meaning	(0008,0104)	LO	o	ALWAYS	AUTO
>>Numeric Value	(0040,A30A)	DS		ALWAYS	AUTO
>>Relationship Type	(0040,A010)	CS	CONTAINS	ALWAYS	AUTO
>>Value Type	(0040,A040)	CS	NUM	ALWAYS	AUTO
>>Concept Name Code Sequence	(0040,A043)	SQ		ALWAYS	AUTO
>>>Code Value	(0008,0100)	SH	113755	ALWAYS	AUTO
>>>Coding Scheme Designator	(0008,0102)	SH	DCM	ALWAYS	AUTO
>>>Code Meaning	(0008,0104)	LO	Table Horizontal Rotation Angle	ALWAYS	AUTO
>>Measured Value Sequence	(0040,A300)	SQ		ALWAYS	AUTO
>>Measurement Units Code Sequence	(0040,08EA)	SQ		ALWAYS	AUTO
>>>Code Value	(0008,0100)	SH	deg	ALWAYS	AUTO
>>>Coding Scheme Designator	(0008,0102)	SH	UCUM	ALWAYS	AUTO
>>>Code Meaning	(0008,0104)	LO	o	ALWAYS	AUTO
>>Numeric Value	(0040,A30A)	DS		ALWAYS	AUTO
>>Relationship Type	(0040,A010)	CS	CONTAINS	ALWAYS	AUTO
>>Value Type	(0040,A040)	CS	NUM	ALWAYS	AUTO
>>Concept Name Code Sequence	(0040,A043)	SQ		ALWAYS	AUTO
>>>Code Value	(0008,0100)	SH	113756	ALWAYS	AUTO
>>>Coding Scheme Designator	(0008,0102)	SH	DCM	ALWAYS	AUTO
>>>Code Meaning	(0008,0104)	LO	Table Cradle Tilt Angle	ALWAYS	AUTO
>>Measured Value Sequence	(0040,A300)	SQ		ALWAYS	AUTO
>>Measurement Units Code Sequence	(0040,08EA)	SQ		ALWAYS	AUTO
>>>Code Value	(0008,0100)	SH	deg	ALWAYS	AUTO
>>>Coding Scheme Designator	(0008,0102)	SH	UCUM	ALWAYS	AUTO
>>>Code Meaning	(0008,0104)	LO	o	ALWAYS	AUTO
>>Numeric Value	(0040,A30A)	DS		ALWAYS	AUTO
>>Relationship Type	(0040,A010)	CS	HAS CONCEPT MOD	ALWAYS	AUTO

Attribute Name	Tag	VR	Value	Presence of Value	Source
>>Value Type	(0040,A040)	CS	CODE	ALWAYS	AUTO
>>Concept Name Code Sequence	(0040,A043)	SQ		ALWAYS	AUTO
>>>Code Value	(0008,0100)	SH	123014	ALWAYS	AUTO
>>>Coding Scheme Designator	(0008,0102)	SH	DCM	ALWAYS	AUTO
>>>Code Meaning	(0008,0104)	LO	Target Region	ALWAYS	AUTO

Attribute Name	Tag	VR	Value	Presence of Value	Source
>>Concept Code Sequence	(0040,A168)	SQ		ALWAYS	AUTO
>>>Code Value	(0008,0100)	SH	CSD CV CM	ALWAYS	AUTO
>>>Coding Scheme Designator	(0008,0102)	SH	SRT T-D4000 Abdomen	ALWAYS	AUTO
>>>Code Meaning	(0008,0104)	LO	SRT T-15750 Ankle joint	ALWAYS	AUTO
			SRT T-D8200 Arm		
			SRT T-04000 Breast		
			SRT T-11501 Cervical spine		
			SRT T-D3000 Chest		
			SRT T-12310 Clavicle		
			SRT T-11BF0 Coccyx		
			SRT T-D8300 Elbow		
			SRT T-D0010 Entire body		
			SRT T-D0300 Extremity		
			SRT T-D9700 Foot		
			SRT T-D8700 Hand		
			SRT T-D1100 Head		
			SRT T-32000 Heart		
			SRT T-15710 Hip joint		
			SRT T-D9200 Knee		
			SRT T-D9400 Leg		
			SRT T-11503 Lumbar spine		
			SRT T-D1600 Neck		
			SRT T-D6000 Pelvis		
SRT T-11AD0 Sacrum					
SRT T-D2220 Shoulder					
SRT T-11100 Skull					
SRT T-11502 Thoracic spine					
>>Relationship Type	(0040,A010)	CS	CONTAINS	ALWAYS	AUTO
>>Value Type	(0040,A040)	CS	IMAGE	ALWAYS	AUTO
>>Concept Name Code Sequence	(0040,A043)	SQ		ALWAYS	AUTO
>>>Code Value	(0008,0100)	SH	113795	ALWAYS	AUTO
>>>Coding Scheme Designator	(0008,0102)	SH	DCM	ALWAYS	AUTO
>>>Code Meaning	(0008,0104)	LO	Acquired Image	ALWAYS	AUTO
>>Text Value	(0040,A160)	UT		ALWAYS	AUTO
>Relationship Type	(0040,A010)	CS	CONTAINS	ALWAYS	AUTO
>Value Type	(0040,A040)	CS	CODE	ALWAYS	AUTO

>Concept Name Code Sequence	(0040,A043)	SQ		ALWAYS	AUTO
>>Code Value	(0008,0100)	SH	113854	ALWAYS	AUTO
>>Coding Scheme Designator	(0008,0102)	SH	DCM	ALWAYS	AUTO
>>Code Meaning	(0008,0104)	LO	Source of Dose Information	ALWAYS	AUTO
>Concept Code Sequence	(0040,A168)	SQ		ALWAYS	AUTO
>>Code Value	(0008,0100)	SH	113856	ALWAYS	AUTO
>>Coding Scheme Designator	(0008,0102)	SH	DCM	ALWAYS	AUTO
>>Code Meaning	(0008,0104)	LO	Automated Data Collection	ALWAYS	AUTO

8.1.1.4 Common Modules

**Table 8.1-5
PATIENT MODULE OF CREATED SOP INSTANCES**

Attribute Name	Tag	VR	Value	Presence of Value	Source
Patient's Name	(0010,0010)	PN	From Modality Worklist or user input. Values supplied via Modality Worklist will be entered as received. Maximum 64 characters.	ALWAYS	MWL/USER
Patient ID	(0010,0020)	LO	From Modality Worklist or user input. Maximum 64 characters.	ALWAYS	MWL/USER
Patient's Birth Date	(0010,0030)	DA	From Modality Worklist or user input	VNAP	MWL/USER
Patient's Sex	(0010,0040)	CS	From Modality Worklist or user input	ALWAYS	MWL/USER
Patient Comments	(0010,4000)	LT	From User Input. Maximum 1024 characters.	ANAP	MWL/USER
Other Patient IDs	(0010, 1000)	LO	From Modality Worklist or user input	ANAP	MWL/USER
Other Patient Names	(0010, 1001)	PN	From Modality Worklist or user input	ANAP	MWL/USER
Ethnic Group	(0010, 2160)	SH	From Modality Worklist or user input	ANAP	MWL/USER

**Table 8.1-6
GENERAL STUDY MODULE OF CREATED SOP INSTANCES**

Attribute Name	Tag	VR	Value	Presence of Value	Source
Study Instance UID	(0020,000D)	UI	From Modality Worklist or generated by device	ALWAYS	MWL/AUTO
Study Date	(0008,0020)	DA	<yyyymmdd>	ALWAYS	AUTO
Study Time	(0008,0030)	TM	<hhmmss>	ALWAYS	AUTO
Referring Physician's Name	(0008,0090)	PN	From Modality Worklist	VNAP	MWL
Study ID	(0020,0010)	SH	Requested Procedure ID from Worklist or User Input	ALWAYS	MWL/USER
Accession Number	(0008,0050)	SH	From Modality Worklist or user input	VNAP	MWL/USER
Study Description	(0008,1030)	LO	User input	VNAP	USER
Physician(s) of Record	(0008,1048)	PN	User input	ANAP	USER
Name of Physician(s) Reading Study	(0008,1060)	PN	From Modality Worklist or user input	ANAP	MWL/USER

**Table 8.1-7
PATIENT STUDY MODULE OF CREATED SOP INSTANCES**

Attribute Name	Tag	VR	Value	Presence of Value	Source
Patient's Age	(0010,1010)	AS	Calculated from DoB input on base of actual Date	ALWAYS	AUTO
Patient's Size	(0010,1020)	DS	From Modality Worklist or user input	ANAP	MWL/ USER
Patient's Weight	(0010,1030)	DS	From Modality Worklist or user input	ANAP	MWL/ USER
Occupation	(0010,2180)	SH	From Modality Worklist or user input	VNAP	MWL/ USER
Additional Patient's History	(0010,21B0)	LT	From Modality Worklist or user input	ANAP	MWL/ USER
Referenced Study Component Sequence	(0008,1111)	SQ		ALWAYS	AUTO
Referenced SOP Class UID	(0008,1150)	UI		ALWAYS	AUTO
Referenced SOP Instance UID	(0008,1155)	UI		ALWAYS	AUTO

**Table 8.1-8
GENERAL SERIES MODULE OF CREATED SOP INSTANCES**

Attribute Name	Tag	VR	Value	Presence of Value	Source
Modality	(0008,0060)	CS	XA	ALWAYS	AUTO
Series Instance UID	(0020,000E)	UI	Generated by device	ALWAYS	AUTO
Series Number	(0020,0011)	IS	Generated by device	ALWAYS	AUTO
Series Date	(0008,0021)	DA	<yyyymmdd>	ALWAYS	AUTO
Series Time	(0008,0031)	TM	<hhmmss>	ALWAYS	AUTO
Performing Physician's Name	(0008,1050)	PN	user input	ANAP	USER
Protocol Name	(0018,1030)	LO	user input	VNAP	USER
Series Description	(0008,103E)	LO	user input	ANAP	USER
Operator's Name	(0008,1070)	PN	Operator field in Study list. Maximum 64 characters.	ANAP	USER
Body Part Examined	(0018,0015)	CS	user input	ANAP	USER
Performed Procedure Step ID	(0040,0253)	SH		ANAP	AUTO
Performed Procedure Step Start Date	(0040,0244)	DA	<yyyymmdd>	ANAP	AUTO
Performed Procedure Step Start Time	(0040,0245)	TM	<hhmmss>	ANAP	AUTO
Performed Procedure Step Description	(0040,0254)	LO		ANAP	AUTO

**Table 8.1-9
GENERAL EQUIPMENT MODULE OF CREATED SOP INSTANCES**

Attribute Name	Tag	VR	Value	Presence of Value	Source
Manufacturer	(0008,0070)	LO	TOSHIBA_MEC	ALWAYS	AUTO
Institution Name	(0008,0080)	LO	From Configuration	ALWAYS	CONFIG
Institution Address	(0008,0081)	ST			
Station Name	(0008,1010)	SH	From Configuration	ALWAYS	CONFIG
Institution Department Name	(0008,1040)	LO	From Configuration	VNAP	CONFIG
Manufacturer's Model Name	(0008,1090)	LO	DFP-8000D	ALWAYS	AUTO
Device Serial Number	(0018,1000)	LO	From Configuration	VNAP	CONFIG
Software Version	(0018,1020)	LO	From Configuration	VNAP	CONFIG

**Table 8.1-10
GENERAL IMAGE MODULE OF CREATED SOP INSTANCES**

Attribute Name	Tag	VR	Value	Presence of Value	Source
Image Number	(0020,0013)	IS	Generated by device	ALWAYS	AUTO
Content Date	(0008,0023)	DA	<yyyymmdd>	ALWAYS	AUTO
Content Time	(0008,0033)	TM	<hhmmss>	ALWAYS	AUTO
Image Type	(0008,0008)	CS		ALWAYS	AUTO
Acquisition Number	(0020,0012)	IS	Generated by device	ALWAYS	AUTO
Acquisition Date	(0008,0022)	DA	<yyyymmdd>	ALWAYS	AUTO
Acquisition Time	(0008,0032)	TM	<hhmmss>	ALWAYS	AUTO
Referenced Image Sequence	(0008,1140)	SQ		ANAP	AUTO
>Referenced SOP Class UID	(0008,1150)	UI		ANAP	AUTO
>Referenced SOP Instance UID	(0008,1155)	UI		ANAP	AUTO
Source Image Sequence	(0008,2112)	SQ		ANAP	AUTO
>Referenced SOP Class UID	(0008,1150)	UI		ANAP	AUTO
>Referenced SOP Instance UID	(0008,1150)	UI		ANAP	AUTO
Image Comments	(0020,4000)	LT	From user input. Maximum 1024 characters.	VNAP	USER
Instance Creation Date	(0008,0012)	DA	<yyyymmdd>	ALWAYS	AUTO
Instance Creation Time	(0008,0013)	TM		ALWAYS	AUTO
Instance Creator UID	(0008,0014)	UI		ALWAYS	AUTO

**Table 8.1-11
IMAGE PIXEL MODULE OF CREATED SOP INSTANCES**

Attribute Name	Tag	VR	Value	Presence of Value	Source
Samples per Pixel	(0028,0002)	US	1	ALWAYS	AUTO
Photometric Interpretation	(0028,0004)	CS	MONOCHROME2	ALWAYS	AUTO
Rows	(0028,0010)	US	Generated by device	ALWAYS	AUTO
Columns	(0028,0011)	US	Generated by device	ALWAYS	AUTO
Bits Allocated	(0028,0100)	US	Generated by device	ALWAYS	AUTO
Bits Stored	(0028,0101)	US	Generated by device	ALWAYS	AUTO
High Bit	(0028,0102)	US	Generated by device	ALWAYS	AUTO
Pixel Representation	(0028,0103)	US	0	ALWAYS	AUTO
Pixel Data	(7FE0,0010)	OB	Generated by device	ALWAYS	AUTO

**Table 8.1-12
CONTRAST/BOLUS MODULE OF CREATED SOP INSTANCES**

Attribute Name	Tag	VR	Value	Presence of Value	Source
Contrast/Bolus Agent	(0018,0010)	LO		VNAP	USER
Contrast/Bolus Route	(0018,1040)	LO		ANAP	USER
Contrast/Bolus Volume	(0018,1041)	DS		ANAP	AUTO
Contrast/Bolus Start Time	(0018,1042)	TM		ANAP	AUTO
Contrast/Bolus Stop Time	(0018,1043)	TM		ANAP	AUTO
Contrast Flow Rate(s)	(0018,1046)	DS		ANAP	AUTO
Contrast Flow Duration(s)	(0018,1047)	DS		ANAP	AUTO
Contrast/Bolus Ingredient	(0018,1048)	CS		ANAP	AUTO
Contrast/Bolus Ingredient Concentration	(0018,1049)	DS		ANAP	AUTO

**Table 8.1-13
CINE MODULE OF CREATED SOP INSTANCES**

Attribute Name	Tag	VR	Value	Presence of Value	Source
Frame Time	(0018,1063)	DS	Set when DA acquisition or fluoroscopy recording is performed	ANAP	AUTO
Frame Time Vector	(0018,1065)	DS		ALWAYS	AUTO
Recommended Display Frame Rate	(0008,2144)	IS		ALWAYS	AUTO

Table 8.1-14
MULTI FRAME MODULE OF CREATED SOP INSTANCES

Attribute Name	Tag	VR	Value	Presence of Value	Source
Number of Frames	(0028,0008)	IS		ALWAYS	AUTO
Frame Incremental Pointer	(0028,0009)	AT	0x00181063/0x00181065	ALWAYS	AUTO

Table 8.1-15
FRAME POINTERS MODULE OF CREATED SOP INSTANCES

Attribute Name	Tag	VR	Value	Presence of Value	Source
Representative Frame Number	(0028,6010)	US		ALWAYS	AUTO

Table 8.1-16
DISPLAY SHUTTER MODULE OF CREATED SOP INSTANCES

Attribute Name	Tag	VR	Value	Presence of Value	Source
Shutter Shape	(0018,1600)	CS	RECTANGULAR	ANAP	USER
Shutter Left Vertical Edge	(0018,1602)	IS		ANAP	USER
Shutter Right Vertical Edge	(0018,1604)	IS		ANAP	USER
Shutter Upper Horizontal Edge	(0018,1606)	IS		ANAP	USER
Shutter Lower Horizontal Edge	(0018,1608)	IS		ANAP	USER

Table 8.1-17
DEVICE MODULE OF CREATED SOP INSTANCES

Attribute Name	Tag	VR	Value	Presence of Value	Source
Device Sequence	(0050,0010)	SQ		ANAP	AUTO
>Device Length	(0050,0014)	DS		ANAP	AUTO
>Device Diameter	(0050,0016)	DS		ANAP	AUTO
>Device Volume	(0050,0018)	DS		ANAP	AUTO
>Inter-marker Distance	(0050,0019)	DS		ANAP	AUTO
>Device Description	(0050,0020)	LO		ANAP	AUTO

8.1.1.5 XA Image Modules

Table 8.1-18
X-RAY IMAGE MODULE OF CREATED XA IMAGE SOP INSTANCES

Attribute Name	Tag	VR	Value	Presence of Value	Source
Frame Increment Pointer	(0028,0009)	DS		ALWAYS	AUTO
Image Type	(0008,0008)	DS		ALWAYS	AUTO
Pixel Intensity Relationship	(0028,1040)	DS	DISP/LIN	ALWAYS	AUTO
Samples per Pixel	(0028,0002)	DS	1	ALWAYS	AUTO
Photometric Interpretation	(0028,0004)	DS	MONOCHROME2	ALWAYS	AUTO
Bits Allocated	(0028,0100)	US		ALWAYS	AUTO
Bits Stored	(0028,0101)	US		ALWAYS	AUTO
High Bit	(0028,0102)	US		ALWAYS	AUTO
Pixel Representation	(0028,0103)	US	0	ALWAYS	AUTO
Reference Image Sequence	(0008,1140)	SQ		ALWAYS	AUTO
>Reference SOP Class UID	(0008,1150)	UI		ALWAYS	AUTO
>Reference SOP Instance UID	(0008,1155)	UI		ALWAYS	AUTO

Table 8.1-19
X-RAY ACQUISITION MODULE OF CREATED XA IMAGE SOP INSTANCES

Attribute Name	Tag	VR	Value	Presence of Value	Source
KVP	(0018, 0060)	DS		ALWAYS	AUTO
Radiation Setting	(0018, 1155)	CS		ALWAYS	AUTO
X-Ray Tube Current	(0018, 1151)	IS		ALWAYS	AUTO
Exposure Time	(0018, 1150)	IS		ALWAYS	AUTO
Intensifier Size	(0018, 1162)	DS		ALWAYS	AUTO
Average Pulse Width	(0018, 1154)	DS		ALWAYS	AUTO
Field of View Shape	(0018, 1147)	CS	ROUND/RECTANGLE	ALWAYS	AUTO
Field of View Dimension(s)	(0018, 1149)	IS		ALWAYS	AUTO
Imager Pixel Spacing	(0018, 1164)	DS		ALWAYS	AUTO
Image Area Dose Product	(0018, 115E)	DS		ANAP	AUTO
Focal Spot(s)	(0018, 1190)	DS		ALWAYS	AUTO

**Table 8.1-20
TABLE MODULE OF CREATED XA IMAGE SOP INSTANCES**

Attribute Name	Tag	VR	Value	Presence of Value	Source
Table Motion	(0018, 1134)	CS	STATIC/DYNAMIC	ALWAYS	AUTO
Table Vertical Increment	(0018, 1135)	DS	Set when Table Motion is DYNAMIC	VNAP	AUTO
Table Longitudinal Increment	(0018, 1137)	DS	Set when Table Motion is DYNAMIC	VNAP	AUTO
Table Lateral Increment	(0018, 1136)	DS	Set when Table Motion is DYNAMIC	VNAP	AUTO
Table Angle	(0018, 1138)	DS		ANAP	AUTO

**Table 8.1-21
POSITIONER MODULE OF CREATED XA IMAGE SOP INSTANCES**

Attribute Name	Tag	VR	Value	Presence of Value	Source
Distance Source to Patient	(0018, 1111)	DS		ALWAYS	AUTO
Distance Source to Detector	(0018, 1110)	DS		ALWAYS	AUTO
Estimated Radiographic Magnification Factor	(0018, 1114)	DS		ANAP	AUTO
Positioner Motion	(0018, 1500)	CS	STATIC/DYNAMIC	ALWAYS	AUTO
Positioner Primary Angle	(0018, 1510)	DS		ALWAYS	AUTO
Positioner Secondary Angle	(0018, 1511)	DS		ALWAYS	AUTO
Positioner Primary Angle Increment	(0018, 1520)	DS	Set when Positioner Motion is DYNAMIC	ANAP	AUTO
Positioner Secondary Angle Increment	(0018, 1521)	DS	Set when Positioner Motion is DYNAMIC	ANAP	AUTO

**Table 8.1-22
CURVE MODULE OF CREATED XA IMAGE SOP INSTANCES**

Attribute Name	Tag	VR	Value	Presence of Value	Source
Curve Dimensions	(50xx, 0005)	US		ANAP	AUTO
Number of Points	(50xx, 0010)	US		ANAP	AUTO
Type of Data	(50xx, 0020)	CS		ANAP	AUTO
Data Value Representation	(50xx, 0103)	US		ANAP	AUTO
Curve Data	(50xx, 3000)	OW		ANAP	AUTO
Axis Units	(50xx, 0030)	SH		ANAP	AUTO
Curve Data Descriptor	(50xx, 0110)	US		ANAP	AUTO
Coordinate Start Value	(50xx, 0112)	US		ANAP	AUTO
Coordinate Step Value	(50xx, 0114)	US		ANAP	AUTO

**Table 8.1-23
VOI/LUT MODULE OF CREATED XA IMAGE SOP INSTANCES**

Attribute Name	Tag	VR	Value	Presence of Value	Source
VOI LUT Sequence	(0028,3010)	SQ		ANAP	AUTO
>LUT descriptor	(0028,3002)	SS	Set when VOI LUT Sequence is present	ANAP	AUTO
>LUT Explanation	(0028,3003)	LO		ANAP	AUTO
>LUT Data	(0028,3006)	OB	Set when VOI LUT Sequence is present	ANAP	AUTO

**Table 8.1-24
SOP COMMON MODULE OF CREATED XA IMAGE SOP INSTANCES**

Attribute Name	Tag	VR	Value	Presence of Value	Source
Specific Character set	(0008,0008)	CS	Refer to 6	ANAP	CONFIG
SOP Class UID	(0008,0016)	UI	1.2.840.10008.5.1.4.1.1.12.1	ALWAYS	AUTO
SOP Instance UID	(0008,0018)	UI	Generated by device	ALWAYS	AUTO

**Table 8.1-25
IMAGE PLANE MODULE OF CREATED XA IMAGE SOP INSTANCES**

Attribute Name	Tag	VR	Value	Presence of Value	Source
Pixel Spacing	(0028,0030)	DS		ALWAYS	AUTO

8.1.2 Usage of Attributes from received IOD's

No SOP Class specific fields are required.

8.1.3 Attribute Mapping

The tables below show the relationships between attributes received via Modality Worklist, stored in acquired images and communicated via MPPS.

The cell content conventions should be read as follows:

- Copy: The value will be copied from a corresponding source attribute of another DICOM object, as defined by the table column.
- Copy from: <DICOM attribute>: The source as specified in the referenced DICOM attribute will be used instead of using the DICOM attribute of the same row as the source.
- Equal (internally generated): The value will be internally generated which may be used in more than one DICOM object.

Table 8.1-26
SCHEDULED CASE - ATTRIBUTE MAPPING BETWEEN MODALITY WORKLIST, IMAGE AND MPPS

Attribute Name	Tag	Modality Worklist	Image IOD		MPPS IOD	
Study Instance UID	(0020,000D)	Source	Copy		Scheduled Step Attributes Sequence (0040,0270)	Copy
Referenced Study Sequence	(0008,1110)	Source	Copy			Copy
Accession Number	(0008,0050)	Source	Copy			Copy
Requested Procedure Description	(0032,1060)	Source	Copy			Copy
Requested Procedure ID	(0040,1001)	Source	Request Attributes Sequence (0040,0275)	Copy		Copy
Scheduled Procedure Step ID	(0040,0009)	Source		Copy		Copy
Scheduled Procedure Step Description	(0040,0007)	Source		Copy		Copy
Scheduled Protocol Code Sequence	(0040,0008)	Source		Copy		Copy
Performed Protocol Code Sequence	(0040,0260)	-	Equal (internally generated).		Equal (internally generated).	
Study ID	(0020,0010)	-	Copy from: Requested Procedure ID (0040,1001).		Copy from: Requested Procedure ID (0040,1001).	
Performed Procedure Step ID	(0040,0253)	-	Equal (internally generated).		Equal (internally generated).	
Performed Procedure Step Start Date	(0040,0244)	-	Equal (internally generated).		Equal (internally generated).	
Performed Procedure Step Start Time	(0040,0245)	-	-		Equal (internally generated).	

Performed Procedure Step Description	(0040,0254)	-	Copy from: Scheduled Procedure Step Description (0040,0007).		Copy from: Scheduled Procedure Step Description (0040,0007).
Requested Procedure Code Sequence	(0032,1064)	Value will be used for Procedure Code Sequence as specified below.	-		-
Procedure Code Sequence	(0008,1032)	-	Copy from: Requested Procedure Code Sequence (0032,1064).		Copy from: Requested Procedure Code Sequence (0032,1064).
Referenced SOP Class UID	(0008,1150)	Source	Referenced PPS Sequence (0008,1111)	1.2.840.10008.3.1.2.3.3	Copy
Referenced SOP Instance UID	(0008,1155)	Source		Equal to SOP Instance of the associated MPPS.	Copy
Scheduled Performing Physician's Name	(0040,0006)	Value will be used for Performing Physician's Name as specified below.	-		-
Performing Physician's Name	(0008,1050)	-	Copy from: Scheduled Performing Physician's Name (0040,0006).		Performed Series Sequence (0040,0340) Copy from: Scheduled Performing Physician's Name (0040,0006). Equal (internally generated).
Protocol Name	(0018,1030)	-	Equal (internally generated).		

**Table 8.1-27
UNSCHEDULED CASE - ATTRIBUTE MAPPING BETWEEN IMAGE AND MPPS**

Attribute Name	Tag	Image IOD		MPPS IOD	
Study Instance UID	(0020,000D)	Equal (internally generated).		Scheduled Step Attributes Sequence (0040,0270)	Equal (internally generated).
Referenced Study Sequence	(0008,1110)	-			Zero Length
Accession Number	(0008,0050)	Equal (internally generated).			Zero Length
Requested Procedure Description	(0032,1060)	-			Zero Length
Requested Procedure ID	(0040,1001)	Request Attributes Sequence (0040,0275)	-		Zero Length
Scheduled Procedure Step ID	(0040,0009)		-		Zero Length
Scheduled Procedure Step Description	(0040,0007)		-		Zero Length
Scheduled Protocol Code Sequence	(0040,0008)		-		Zero Length

Performed Protocol Code Sequence	(0040,0260)	-	Zero Length
Study ID	(0020,0010)	Equal (internally generated).	Equal (internally generated).
Performed Procedure Step ID	(0040,0253)	Zero Length	-
Performed Procedure Step Start Date	(0040,0244)	-	Equal (internally generated).
Performed Procedure Step Start Time	(0040,0245)	-	Equal (internally generated).
Performed Procedure Step Description	(0040,0254)	-	Zero Length
Requested Procedure Code Sequence	(0032,1064)	-	-
Procedure Code Sequence	(0008,1032)	-	Zero Length
Referenced SOP Class UID	(0008,1150)	Referenced PPS Sequence (0008,1111)	1.2.840.10008.3.1.2.3.3
Referenced SOP Instance UID	(0008,1155)		Equal to SOP Instance of the associated MPPS.
Performing Physician's Name	(0008,1050)	-	Performed Series Sequence (0040,0340)
Protocol Name	(0018,1030)	Equal (internally generated).	
			Equal (internally generated).

8.1.4 Coerced/Modified Fields

Not applicable to this product

8.2 DATA DICTIONARY OF PRIVATE ATTRIBUTES

This product reserves blocks of private attributes in groups 0029 and 7079.

The Private Attributes added to created SOP Instances are listed in the Table below. Further details on usage of these private attributes are contained in Section 8.1.

**Table 8.2-1
DATA DICTIONARY OF PRIVATE ATTRIBUTES**

Tag	Attribute Name	VR	VM
(0029,00xx)	Private Creator Code	LO	1
(0029,xx08)	Data	CS	1-n
(0029,xx09)	Data	LO	1-n
(0029,xx10)	Data	LO	1-n
(0029,xx31)	Data	LO	1-n
(0029,xx32)	Data	UL	1-n
(0029,xx33)	Data	UL	1-n
(0029,xx34)	Data	CS	1-n

(7079,00xx)	Private Creator Code	LO	1
(7079,xx21)	Image Attribute Flag	SH	5
(7079,xx22)	Playback Speed	IS	2
(7079,xx23)	Frame Information	IS	2
(7079,xx24)	Injection Time	DS	1
(7079,xx25)	Calibration Status	SH	1
(7079,xx26)	Pixel Size	DS	2
(7079,xx27)	Mask Frame Range	US	2
(7079,xx28)	Contrast Stage Number	US	1
(7079,xx29)	Contrast Frame Range	US	10
(7079,xx2A)	Original Image Attribute	US	5
(7079,xx2C)	Section Status	SH	3
(7079,xx2D)	Section Frame Range	SS	2
(7079,xx2E)	External Trigger Playback	SH	1
(7079,xx2F)	Stage Specific Section	SH	1
(7079,xx30)	Contrast Stage Number	US	1
(7079,xx31)	Contrast Frame Table	US	1-n
(7079,xx32)	Remask Status	SH	2
(7079,xx33)	Mask Frame Table	US	1-n
(7079,xx34)*	Pixel Shift Status	SH	2
(7079,xx35)*	Pixel Shift Area	SH	8
(7079,xx36)*	Pixel Shift ROI Shape	SH	8
(7079,xx37)*	Pixel Shift ROI Area	US	32
(7079,xx38)	Pixel Shift X	SS	1-n
(7079,xx39)	Pixel Shift Y	SS	1-n
(7079,xx3A)	Mask/Contrast Average	US	2
(7079,xx3B)	Zoom Status	SH	1
(7079,xx3C)	Zoom Factor	DS	3
(7079,xx3D)*	Roaming	SS	2
(7079,xx3E)	Subtraction Status	SH	1
(7079,xx3F)	Mask Frame	US	2
(7079,xx40)	Subtraction Type	SH	2
(7079,xx41)	Landmark Coefficient	SS	2
(7079,xx42)	Cardiac Subtraction Status	SH	1
(7079,xx43)	TID Status	SH	1
(7079,xx44)	TID Interval	US	1
(7079,xx45)	Rotation Status	SH	1
(7079,xx46)*	Rotation Angle	SS	2
(7079,xx47)	Window Information	SS	18
(7079,xx48)	Spatial Filter Information	SS	12
(7079,xx49)	Auto Window Status	US	3
(7079,xx4A)	Test Exposure Coefficient	US	1
(7079,xx4B)*	Program Attribute	LO	7

(7079,xx4C)	Program Parameter	OB	1
(7079,xx4D)	Image Processing Control	SH	3
(7079,xx4E)*	Component Position	SL	46
(7079,xx4F)	ECG Status	SH	3
(7079,xx50)	ECG Data	US	1-n
(7079,xx51)	Pressure Data	US	1-n
(7079,xx52)	Heart Beat	US	1
(7079,xx53)	ABC ROI Type	SH	1
(7079,xx54)	ABC ROI Area	US	5
(7079,xx55)	SEC History	UL	47-47n
(7079,xx56)	Mask Stage Number for SDSA	US	1
(7079,xx57)	Mask Frame for SDSA	US	1-n
(7079,xx58)	Contrast Stage Number for SDSA	US	1
(7079,xx59)	Contrast Frame Range for SDSA	US	2-2n
(7079,xx5A)	Contrast Stage Number for RDSA	US	1
(7079,xx5B)	Mask Frame Range for RDSA	US	2
(7079,xx5C)	Contrast Frame Range for RDSA	US	2-2n
(7079,xx5D)	Sequence Mode for RDSA	SH	1
(7079,xx5E)	Stereo Display for RDSA	US	2
(7079,xx5F)	Window for SDSA	SS	4-4n
(7079,xx60)	Original Mask Frame Table	US	1-n
(7079,xx61)	Historical Data for SDSA	SS	30-30n
(7079,xx62)	Historical Data for RDSA	US	4
(7079,xx63)	X-ray trigger (mask stage) for RDSA	US	1-n
(7079,xx64)	Camera timing (mask stage) for RDSA	US	1-n
(7079,xx65)	Pulse width (mask stage) for RDSA	US	1-n
(7079,xx66)	X-ray trigger (1st contrast stage) for RDSA	US	1-n
(7079,xx67)	Camera timing (1st contrast stage) for RDSA	US	1-n
(7079,xx68)	Pulse width (1st contrast stage) for RDSA	US	1-n
(7079,xx69)	X-ray trigger (2nd contrast stage) for RDSA	US	1-n
(7079,xx6A)	Camera timing (2nd contrast stage) for RDSA	US	1-n
(7079,xx6B)	Pulse width (2nd contrast stage) for RDSA	US	1-n
(7079,xx6C)	Image Processing Control Step	US	1
(7079,xx6D)	Injector Offset Time	DS	1
(7079,xx6E)	Referenced LOID	DS	1
(7079,xx6F)	Primary Angle of another plane	DS	1
(7079,xx70)	Secondary Angle of another plane	DS	1
(7079,xx71)	Primary Angle Increment of another plane	DS	1-n
(7079,xx72)	Secondary Angle Increment of another plane	DS	1-n
(7079,xx73)	CT Position	SL	4
(7079,xx74)*	Component Position of another plane	SL	32
(7079,xx75)	Image Flip Flag	SH	1
(7079,xx76)	Image Rotation Mode	US	1

(7079,xx77)	Start Frame of Fluoro Cyclic Recording	SL	1
(7079,xx78)	Detector Size info	US	1
(7079,xx79)	Detector FOV info	US	1
(7079,xx7A)*	DSA Rotation Data for LCI Mode	US	1
(7079,xx7B)*	Image Quality	SH	1
(7079,xx7C)*	Image Shutter Flag	SH	1
(7079,xx7D)*	Image Shutter info	US	8
(7079,xx7E)	Overlay info	OB	1
(7079,xx7F)*	Image Parameter info	UL	1-n
(7079,xx80)	Detector Type info	LO	1
(7079,xx81)	Pixel Shift table X	SS	1-n
(7079,xx82)	Pixel Shift table Y	SS	1-n

*: Please see Table8.2-2

**Table 8.2-2
CHANGED DATA DICTIONARY OF PRIVATE ATTRIBUTES**

Tag	Changed software version	Comment
(7079,xx34)	V4.00	VM is changed from "1" to "2".
(7079,xx35)	V3.20	VM is changed from "1" to "8".
(7079,xx36)	V3.20	VM is changed from "1" to "8".
(7079,xx37)	V3.20	VM is changed from "4" to "32".
(7079,xx3C)	V3.62	VM is changed from "2" to "3".
(7079,xx46)	V3.62	VM is changed from "1" to "2".
(7079,xx4B)	V3.63	VM is changed from "3" to "7".
(7079,xx4E)	V4.22	VM is changed from "35" to "46".
(7079,xx74)	V3.21	VM is changed from "28" to "32".
(7079,xx7A)	V3.42	This is new attribute added from V3.42.
(7079,xx7B)	V3.42	This is new attribute added from V3.42.
(7079,xx7C)	V3.63	This is new attribute added from V3.63.
(7079,xx7D)	V3.63	This is new attribute added from V3.63.
(7079,xx7F)	V4.30	This is new attribute added from V4.30.

8.3 CONTROLLED TERMINOLOGY AND TEMPLATES

Not applicable to this product

8.4 GRAYSCALE IMAGE CONSISTENCY

Not applicable to this product

8.5 STANDARD EXTENDED/SPECIALIZED/PRIVATE SOP CLASSES

Not applicable to this product

8.6 PRIVATE TRANSFER SYNTAXES

Not applicable to this product

E