

**TOSHIBA**

**DICOM CONFORMANCE STATEMENT  
FOR  
TOSHIBA DIGITAL MAMMOGRAPHY SYSTEM  
  
MODEL MGU-1000D**

**TOSHIBA MEDICAL MANUFACTURING CO., LTD.**

© TOSHIBA MEDICAL MANUFACTURING CO, LTD. 2010  
ALL RIGHTS RESERVED

## **Trademarks**

This document may include trademarks or registered trademarks of other companies.

### **IMPORTANT!**

- (1) No part of this document may be copied or reprinted, in whole or in part, without written permission.
- (2) The contents of this document are subject to change without prior notice and without our legal obligation.

# 1. CONFORMANCE STATEMENT OVERVIEW

Table 1-1 provides an overview of the network services supported by MGU-1000D.

**Table 1-1  
NETWORK SERVICES**

SOP Classes	User of Service (SCU)	Provider of Service (SCP)
<b>Transfer</b>		
Digital Mammography Image Storage – For Presentation	Yes	No
Digital Mammography Image Storage – For Processing	Option (see Note1)	No
<b>Storage Commitment</b>		
Storage Commitment Push Model	Yes	No
<b>Workflow Management</b>		
Modality Worklist Information Model – Find	Option (see Note2)	No
Modality Performed Procedure Step	Option (see Note2)	No
<b>Print Management</b>		
Basic Grayscale Print Management	Yes	No

NOTE 1: Support for the Digital Mammography Image Storage – For Processing Services is a separately licensable option.

NOTE 2: Support for the Workflow Services is a separately licensable option.

Table 1-2 provides an overview of the media storage application profiles supported by MGU-1000D.

**Table 1-2  
MEDIA SERVICES**

SOP Classes	Write Files (FSC)	Update Files (FSU)	Read Files (FSR)
<b>Compact Disk - Recordable</b>			
General Purpose CD-R Interchange	Yes	No	No

## 2. TABLE OF CONTENTS

<b>1.</b>	<b>CONFORMANCE STATEMENT OVERVIEW .....</b>	<b>i</b>
<b>2.</b>	<b>TABLE OF CONTENTS .....</b>	<b>a</b>
<b>3.</b>	<b>INTRODUCTION .....</b>	<b>1</b>
3.1	<b>AUDIENCE .....</b>	<b>1</b>
3.2	<b>REMARKS .....</b>	<b>1</b>
3.3	<b>DEFINITIONS, TERMS AND ABBREVIATIONS .....</b>	<b>2</b>
3.4	<b>REFERENCES .....</b>	<b>2</b>
<b>4.</b>	<b>NETWORKING .....</b>	<b>3</b>
4.1	<b>IMPLEMENTATION MODEL .....</b>	<b>3</b>
4.1.1	Application Data Flow .....	3
4.1.2	Functional Definition of AEs .....	5
4.1.3	Sequencing of Real-World Activities .....	6
4.2	<b>AE SPECIFICATIONS .....</b>	<b>8</b>
4.2.1	Storage SCU AE Specification .....	8
4.2.2	Storage Commitment SCU AE Specification .....	11
4.2.3	MWM SCU AE Specification .....	17
4.2.4	MPPS SCU AE Specification .....	22
4.2.5	Print SCU AE Specification .....	27
4.2.6	Verification SCU AE Specification .....	36
4.3	<b>NETWORK INTERFACES .....</b>	<b>39</b>
4.3.1	Physical Network Interface .....	39
4.3.2	Additional Protocols .....	39
4.4	<b>CONFIGURATION .....</b>	<b>39</b>
4.4.1	AE Title/Presentation Address Mapping .....	39
4.4.2	Parameters .....	40
<b>5.</b>	<b>MEDIA INTERCHANGE .....</b>	<b>42</b>
5.1	<b>IMPLEMENTATION MODEL .....</b>	<b>42</b>
5.1.1	Application Data Flow .....	42
5.1.2	Functional Definition of AE .....	42
5.1.3	Sequencing of Real-World Activities .....	42
5.1.4	File Meta Information for Implementation Class and Version .....	43
5.2	<b>AE SPECIFICATIONS .....</b>	<b>43</b>
5.2.1	Offline-Media AE Specification .....	43
5.3	<b>AUGMENTED AND PRIVATE APPLICATION PROFILES .....</b>	<b>44</b>
5.3.1	Augmented Application Profiles .....	44
5.3.2	Private Application Profiles .....	44
5.4	<b>MEDIA CONFIGURATION .....</b>	<b>44</b>
<b>6.</b>	<b>SUPPORT OF CHARACTER SETS .....</b>	<b>45</b>
<b>7.</b>	<b>SECURITY .....</b>	<b>46</b>
<b>8.</b>	<b>ANNEXES .....</b>	<b>47</b>
8.1	<b>IOD CONTENTS .....</b>	<b>47</b>
8.1.1	Created SOP Instances .....	47
8.1.2	Usage of Attributes from received IOD's .....	57

- 8.1.3 Attribute Mapping .....57
- 8.1.4 COERCED/MODIFIED FIELDS.....57
- 8.2 DATA DICTIONARY OF PRIVATE ATTRIBUTES .....58**
- 8.3 CODED TERMINOLOGY AND TEMPLATES .....59**
- 8.4 GRAYSCALE IMAGE CONSISTENCY .....61**
- 8.5 STANDARD EXTENDED/SPECIALIZED/PRIVATE SOP CLASSES .....61**
- 8.6 PRIVATE TRANSFER SYNTAXES .....61**

## 3. INTRODUCTION

### 3.1 AUDIENCE

This document is intended for hospital staff, health system integrators, software designers or implementers. It is assumed that the reader has a working understanding of DICOM.

### 3.2 REMARKS

DICOM, by itself, does not guarantee interoperability. However, the Conformance Statement facilitates a first-level validation for interoperability between different applications supporting the same DICOM functionality.

This Conformance Statement is not intended to replace validation with other DICOM equipment to ensure proper exchange of information intended.

The scope of this Conformance Statement is to facilitate communication with Toshiba Medical Manufacturing and other vendors' Medical equipment. The Conformance Statement should be read and understood in conjunction with the DICOM Standard [DICOM]. However, by itself it is not guaranteed to ensure the desired interoperability and a successful interconnectivity.

The user should be aware of the following important issues:

- The comparison of different conformance statements is the first step towards assessing interconnectivity between Toshiba Medical Manufacturing and non- Toshiba Medical Manufacturing equipment.
- Test procedures should be defined to validate the desired level of connectivity.
- The DICOM standard will evolve to meet the users' future requirements. Toshiba Medical Manufacturing is actively involved in developing the standard further and therefore reserves the right to make changes to its products or to discontinue its delivery.

### 3.3 DEFINITIONS, TERMS AND ABBREVIATIONS

Definitions, terms and abbreviations used in this document are defined within the different parts of the DICOM standard.

Abbreviations and terms are as follows:

<b>AE</b>	Application Entity
<b>AET</b>	Application Entity Title
<b>CD-R</b>	Compact Disc Recordable
<b>DIMSE</b>	DICOM Message Service Element
<b>FSC</b>	File-Set Creator
<b>FSU</b>	File-Set Updater
<b>FSR</b>	File-Set Reader
<b>IE</b>	Information Entity
<b>IOD</b>	Information Object Definition
<b>IR</b>	International Register of Coded Character Sets To Be Used With Escape Sequences
<b>ISO</b>	International Standard Organization
<b>MPPS</b>	Modality Performed Procedure Step
<b>MSPS</b>	Modality Scheduled Procedure Step
<b>MWM</b>	Modality Worklist Management
<b>R</b>	Required Key Attribute
<b>O</b>	Optional Key Attribute
<b>SCU</b>	Service Class User (DICOM client)
<b>SCP</b>	Service Class Provider (DICOM server)
<b>SOP</b>	Service-Object Pair
<b>U</b>	Unique Key Attribute
<b>UID</b>	Unique Identifier

### 3.4 REFERENCES

[DICOM] Digital Imaging and Communications in Medicine (DICOM), NEMA PS 3.1-3.18, 2009

### 4. NETWORKING

#### 4.1 IMPLEMENTATION MODEL

##### 4.1.1 Application Data Flow

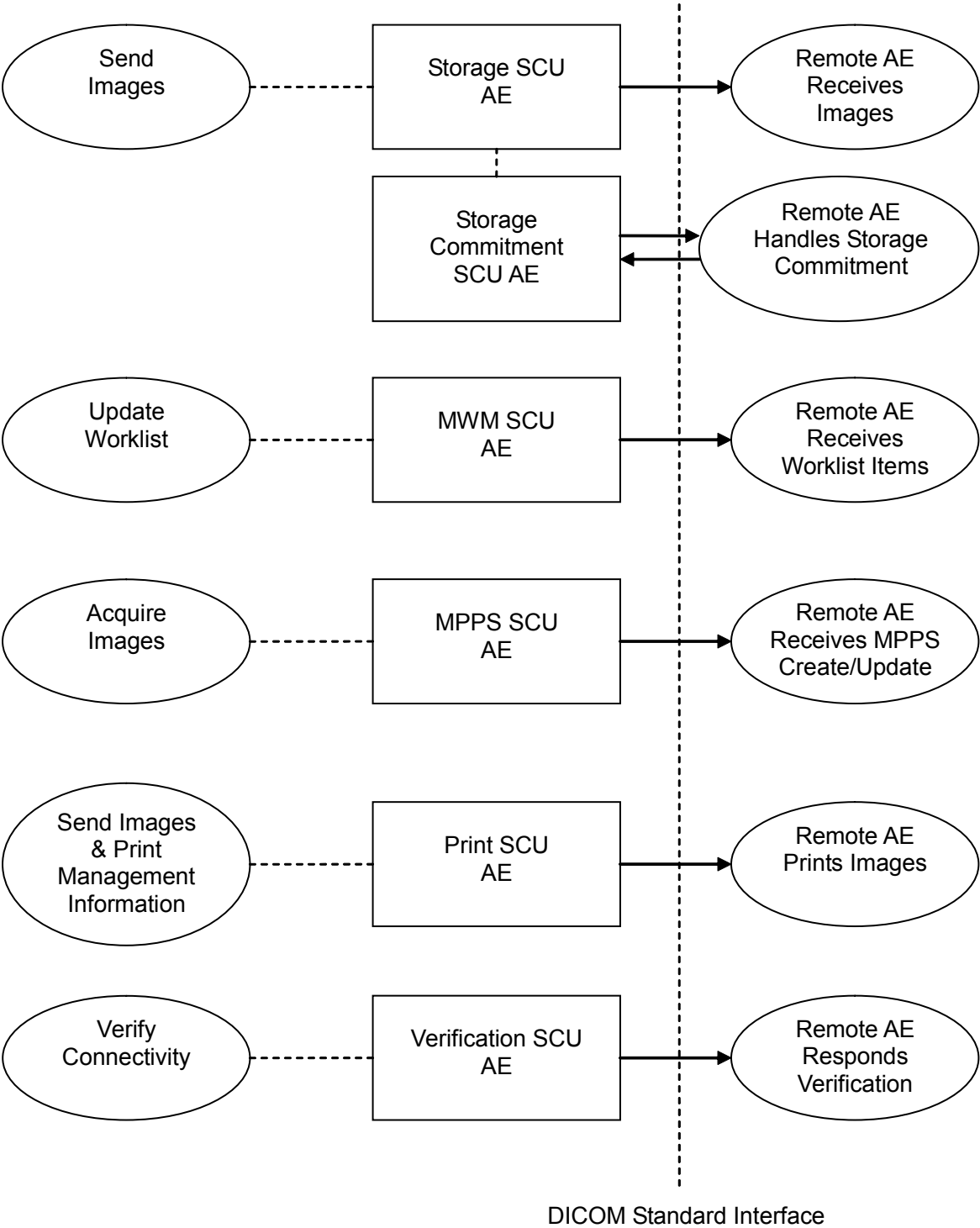

Figure 4.1-1  
APPLICATION DATA FLOW DIAGRAM FOR NETWORKING



- The Storage SCU AE sends images to a remote AE. It is associated with the local real-world activity “Send Images”. “Send Images” is performed upon user request for specific images selected or automatically after acquisition of image or completion of study. If the remote AE is configured as an archive device, the Storage SCU AE will send a storage commitment request to the Storage Commitment SCU AE.
- Receiving the storage commitment request from the Storage SCU AE, the Storage Commitment SCU AE will request Storage Commitment and if a commitment is successfully obtained will record this information in the local database. The Storage Commitment SCU AE can also respond to C-ECHO requests as a Verification SCP.
- The MWM SCU AE receives Worklist information from a remote AE. It is associated with the local real-world activity “Update Worklist”. When the “Update Worklist” is performed the MWM SCU AE queries a remote AE for worklist items and provides the set of worklist items matching the query request. “Update Worklist” is performed manually or automatically.
- The MPPS SCU AE sends MPPS information to a remote AE. It is associated with the local real-world activity “Acquire Images”. When the “Acquire Images” is performed the MPPS SCU AE creates and updates Modality Performed Procedure Step instances managed by a remote AE. Acquisition of images will result in automated creation of an MPPS Instance. Completion of the MPPS is performed as the result of an operator action.
- The Print SCU AE prints images on a remote AE (Printer). It is associated with the local real-world activity “Send Images & Print Management Information”. “Send Images & Print Management Information” creates a print-job within the print queue containing one or more virtual film sheets composed from images selected by the user.
- The Verification SCU AE issues a C-ECHO to verify a DICOM connection to a remote AE. It is associated with the local real-world activity “Verify Connectivity”. “Verify Connectivity” is performed upon user request to verify the connectivity to a remote AE. “Verify Connectivity” to remote AE(s) registered as Image Server is also performed by the local AE periodically (default: every 2 minutes; configurable using the Service Tool by the Field Service Engineer). In this case, the Verification SCU AE attempts to initiate an association and checks the acceptance of each remote AE (negotiation), but does not issue a C-ECHO.

## **4.1.2 Functional Definition of AEs**

### **4.1.2.1 Functional Definition of Storage SCU AE**

The existence of a send-job queue entry with associated network destination will activate the Storage SCU AE. An Association request is sent to the destination AE and upon successful negotiation of a Presentation Context the image transfer is started. If the remote AE is configured as an archive device, the storage SCU AE will send a storage commitment request to the Storage Commitment SCU AE.

If the image transfer fails, the Storage SCU AE will retry this send-job automatically.

### **4.1.2.2 Functional Definition of Storage Commitment SCU AE**

Receiving the storage commitment request from the Storage SCU AE, the Storage Commitment SCU AE will request Storage Commitment and if a commitment is successfully obtained will record this information in the local database

If the storage commitment request fails or is not obtained, the Storage Commitment SCU AE will retry the request next time the system start-up.

### **4.1.2.3 Functional Definition of MWM SCU AE**

The MWM SCU AE attempts to download a worklist from a remote node. If the MWM SCU AE establishes an Association to a remote AE, it will transfer patient's information and worklist items via the open Association. The results will be displayed in a separate list. The patient's information will be used for the patient registration.

### **4.1.2.4 Functional Definition of MPPS SCU AE**

The MPPS SCU AE performs the creation of an MPPS Instance automatically when the user selects and starts a worklist item. Further updates on the MPPS data can be performed when the user completes the acquisition.

### **4.1.2.5 Functional Definition of Print SCU AE**

The existence of a print-job in the print queue will activate the Print SCU AE. An Association is established with the printer and the printer's status determined. If the printer is operating normally, the film sheets described within the print-job will be printed.

If the printer is not operating normally, the Print SCU AE will retry this print-job automatically.

### **4.1.2.6 Functional Definition of Verification SCU AE**

The verification SCU AE issues a C-ECHO to verify a DICOM connection to a remote AE. It is performed upon user request.

The verification SCU AE also attempts to initiate an association, but does not issue a C-ECHO. It is performed by the local AE periodically.

4.1.3 Sequencing of Real-World Activities

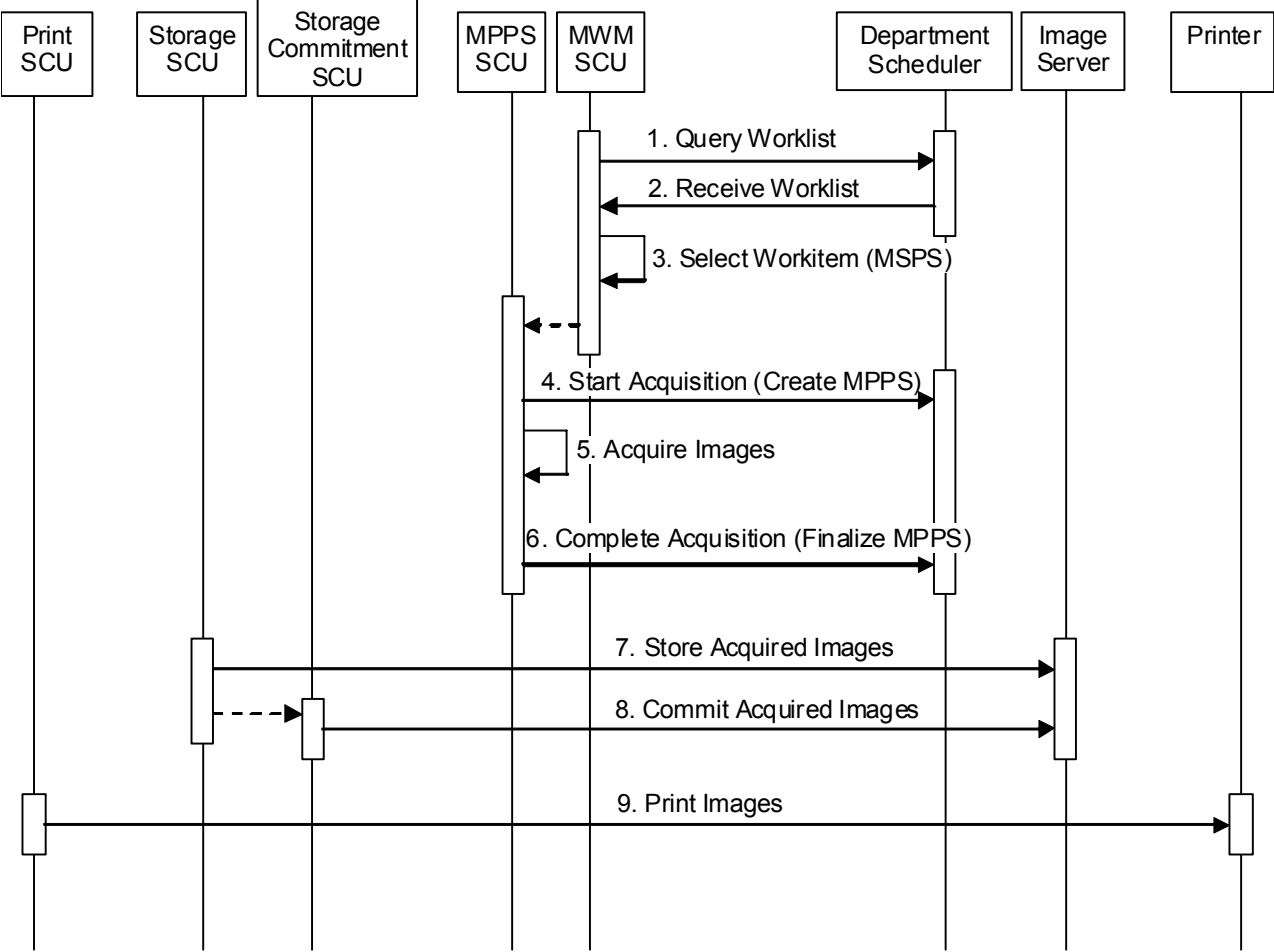

Figure 4.1-2 SEQUENCING CONSTRAINTS

Under typical scheduled workflow conditions the sequencing constraints illustrated in Figure 4.1-2 apply:

1. Query Worklist
2. Receive Worklist of Modality Scheduled Procedure Steps (MSPS)
3. Select Workitem (MSPS) from Worklist
4. Start Acquisition and Create MPPS
5. Acquire Images
6. Complete Acquisition and Finalize MPPS
7. Store Acquired Images
8. Commit Acquired Images
9. Print Images

Other workflow situations (e.g. unscheduled procedure steps) will have other sequencing constraints. Some activities may be omitted according to situations.

## 4.2 AE SPECIFICATIONS

### 4.2.1 Storage SCU AE Specification

#### 4.2.1.1 SOP Classes

The Storage SCU AE provides Standard Conformance to the following SOP Classes:

**Table 4.2-1**  
**SOP CLASSES FOR THE STORAGE SCU AE**

SOP Class Name	SOP Class UID	SCU	SCP
Digital Mammography Image Storage – For Presentation	1.2.840.10008.5.1.4.1.1.1.2	Yes	No
Digital Mammography Image Storage – For Processing	1.2.840.10008.5.1.4.1.1.1.2.1	Yes	No

#### 4.2.1.2 Association Policies

##### 4.2.1.2.1 General

The DICOM standard application context name for DICOM 3.0 is always proposed:

**Table 4.2-2**  
**DICOM APPLICATION CONTEXT FOR THE STORAGE SCU AE**

Application Context Name	1.2.840.10008.3.1.1.1
--------------------------	-----------------------

##### 4.2.1.2.2 Number of Associations

The Storage SCU AE can initiate one Association at a time for each destination to which a transfer request is being processed in the active job queue list. Only one job will be active at a time, the other remains pending until the active job is completed or failed.

**Table 4.2-3**  
**NUMBER OF ASSOCIATIONS INITIATED FOR THE STORAGE SCU AE**

Maximum number of simultaneous Associations	1
---	---

##### 4.2.1.2.3 Asynchronous Nature

The Storage SCU AE does not support asynchronous communication (multiple outstanding transactions over a single Association).

**Table 4.2-4**  
**ASYNCHRONOUS NATURE FOR THE STORAGE SCU AE**

Maximum number of outstanding asynchronous transactions	1
---	---

##### 4.2.1.2.4 Implementation Identifying Information

The implementation information for the Storage SCU AE is:

**Table 4.2-5**  
**DICOM IMPLEMENTATION CLASS AND VERSION FOR THE STORAGE SCU AE**

Implementation Class UID	1.2.392.200036.9116.39.1.1
Implementation Version Name	MGU1000D_V220

**4.2.1.3 Association Initiation Policy**

**4.2.1.3.1 Activity – Send Images**

**4.2.1.3.1.1 Description and Sequencing of Activities**

The Storage SCU AE attempts to initiate a new Association in order to issue a Storage request (C-STORE).

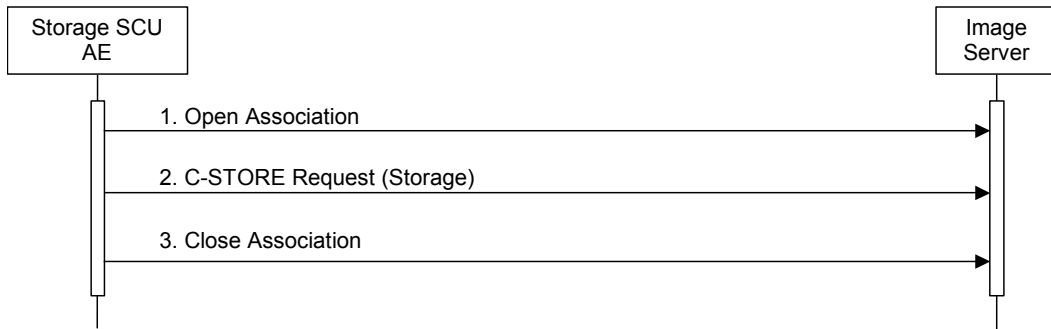

**Figure 4.2-1 SEQUENCING OF ACTIVITY – SEND IMAGES**

A possible sequence of interactions between the Storage SCU AE and an Image Server (e.g. a storage or archive device supporting the Storage SOP Classes as an SCP) is illustrated in the Figure above:

1. The Storage SCU AE opens an Association with the Image Server
2. Acquired images are transmitted to the Image Server using a Storage request (C-STORE) and the Image Server replies with a C-STORE response (status success).
3. The Storage SCU AE closes the Association with the Image Server.

**4.2.1.3.1.2 Proposed Presentation Contexts**

The Storage SCU AE is capable of proposing the Presentation Contexts shown in the following table:

**Table 4.2-6 PROPOSED PRESENTATION CONTEXTS FOR ACTIVITY SEND IMAGES FOR PRESENTATION**

Presentation Context Table					
Abstract Syntax		Transfer Syntax		Role	Ext. Neg.
Name	UID	Name List	UID List		
Digital Mammography Image Storage – For Presentation	1.2.840.10008.5.1.4.1 .1.1.2	Explicit VR Little Endian	1.2.840.10008.1.2.1	SCU	None
Digital Mammography Image Storage – For Presentation	1.2.840.10008.5.1.4.1 .1.1.2	Implicit VR Little Endian	1.2.840.10008.1.2	SCU	None

**Table 4.2-7  
PROPOSED PRESENTATION CONTEXTS FOR ACTIVITY SEND IMAGES FOR PROCESSING**

Presentation Context Table					
Abstract Syntax		Transfer Syntax		Role	Ext. Neg.
Name	UID	Name List	UID List		
Digital Mammography Image Storage – For Processing	1.2.840.10008.5.1.4.1.1.1.2.1	Explicit VR Little Endian	1.2.840.10008.1.2.1	SCU	None
Digital Mammography Image Storage – For Processing	1.2.840.10008.5.1.4.1.1.1.2.1	Implicit VR Little Endian	1.2.840.10008.1.2	SCU	None

#### 4.2.1.3.1.3 SOP Specific Conformance for Storage SOP Classes

The Storage SCU AE provides standard conformance to the Storage Service Class as an SCU.

The behavior of Storage SCU AE when encountering status codes in a C-STORE response is summarized in the table below:

**Table 4.2-8  
STORAGE C-STORE RESPONSE STATUS HANDLING BEHAVIOR**

Service Status	Further Meaning	Status Code	Behavior
Success	Success	0000	The SCP has successfully stored the SOP Instance. If all SOP Instances in a send job have status success then the job is marked as complete.
Refused	Out of Resources	A7xxH	The Association is aborted and the send job is marked as failed. The status meaning is logged and the job failure is reported to the user via the job control application.
Error	Data Set does not match SOP Class	A9xxH	
Error	Cannot Understand	CxxxH	
Warning	Coercion of Data Elements	B000H	
Warning	Data Set does not match SOP Class	B007H	
Warning	Elements Discarded	B006H	
*	*	Any other status code.	

The behavior of Storage SCU AE during communication failure is summarized in the table below:

**Table 4.2-9  
STORAGE COMMUNICATION FAILURE BEHAVIOR**

Exception	Behavior
Timeout	The Association is aborted and the send job is marked as failed. The reason is logged and the job failure is reported to the user via the job control application.
Association aborted by the SCP or network layers	The send job is marked as failed. The reason is logged and the job failure is reported to the user via the job control application.

If the image transfer fails, the Storage SCU AE will retry this send-job automatically. The user is able to cancel the send-jobs.

The contents of Image Storage SOP Instances created by the Storage SCU AE conform to the DICOM Image IOD definitions and are described in section 8.1.

## 4.2.2 Storage Commitment SCU AE Specification

### 4.2.2.1 SOP Classes

The Storage Commitment SCU AE provides Standard Conformance to the following SOP Classes:

**Table 4.2-10**  
**SOP CLASSES FOR THE STORAGE COMMITMENT SCU AE**

SOP Class Name	SOP Class UID	SCU	SCP
Storage Commitment Push Model	1.2.840.10008.1.20.1	Yes	No
Verification	1.2.840.10008.1.1	No	Yes

### 4.2.2.2 Association Policies

#### 4.2.2.2.1 General

The DICOM standard application context name for DICOM 3.0 is always proposed:

**Table 4.2-11**  
**DICOM APPLICATION CONTEXT FOR THE STORAGE COMMITMENT SCU AE**

Application Context Name	1.2.840.10008.3.1.1.1
--------------------------	-----------------------

#### 4.2.2.2.2 Number of Associations

The Storage Commitment SCU AE initiates one Association at a time.

**Table 4.2-12**  
**NUMBER OF ASSOCIATIONS INITIATED FOR THE STORAGE COMMITMENT SCU AE**

Maximum number of simultaneous Associations	1
---	---

The Storage Commitment SCU AE accepts Associations to receive N-EVENT-REPORT notifications for the Storage Commitment Push Model SOP Class.

**Table 4.2-13**  
**NUMBER OF ASSOCIATIONS ACCEPTED FOR THE STORAGE COMMITMENT SCU AE**

Maximum number of outstanding asynchronous transactions	1
---	---

#### 4.2.2.2.3 Asynchronous Nature

The Storage Commitment SCU AE does not support asynchronous communication (multiple outstanding transactions over a single Association).

**Table 4.2-14**  
**ASYNCHRONOUS NATURE FOR THE STORAGE COMMITMENT SCU AE**

Maximum number of outstanding asynchronous transactions	1
---	---

#### 4.2.2.2.4 Implementation Identifying Information

The implementation information for the Storage Commitment SCU AE is:

**Table 4.2-15**  
**DICOM IMPLEMENTATION CLASS AND VERSION FOR THE STORAGE COMMITMENT SCU AE**

Implementation Class UID	1.2.392.200036.9116.39.1.1
Implementation Version Name	MGU1000D_V220



### 4.2.2.3 Association Initiation Policy

#### 4.2.2.3.1 Activity – Commit Sent Images

##### 4.2.2.3.1.1 Description and Sequencing of Activities

If the remote AE is configured as an archive device, the Storage Commitment SCU AE will, after all images have been sent, transmit a single storage commitment request(N-ACTION).Upon receiving the N-ACTION response the Storage Commitment SCU AE will release the Association. The notification of Storage commitment (N-EVENT-REPORT) will be received over a separate Association.

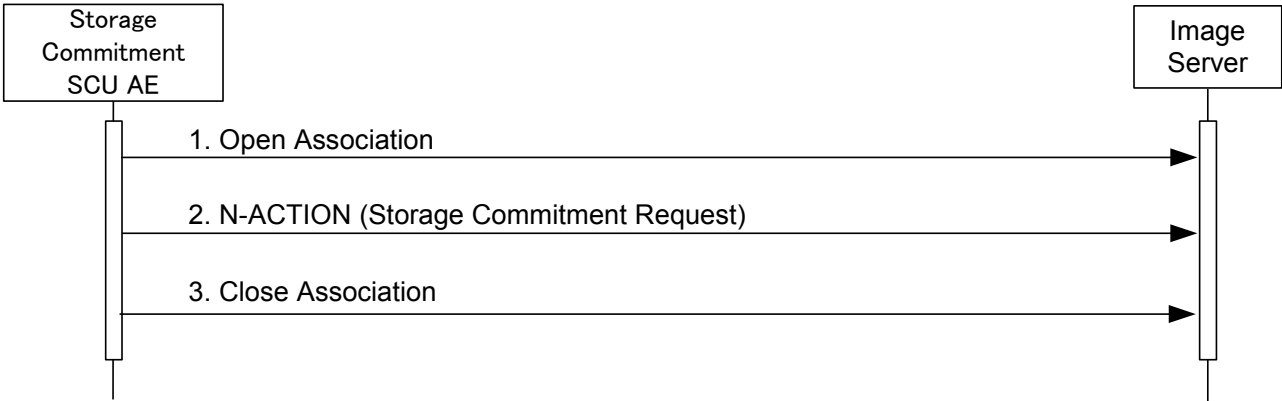

**Figure 4.2-2**  
**SEQUENCING OF ACTIVITY – COMMIT SENT IMAGES**

A possible sequence of interactions between the Storage Commitment SCU AE and an Image Server (e.g. a storage or archive device supporting the Storage Commitment SOP Classes as an SCP) is illustrated in the Figure above:

1. The Storage Commitment SCU AE opens an Association with the Image Server.
2. A Storage Commitment request (N-ACTION) is transmitted to the Image Server to obtain Storage Commitment of previously transmitted images. The Image Server replies with an N-ACTION response indicating the request has been received and is being processed.
3. The Storage Commitment SCU AE closes the Association with the Image Server.

NOTE: The N-EVENT-REPORT will be sent over a separate Association initiated by the Image Server (see Section 4.2.2.4.1).

#### 4.2.2.3.1.2 Proposed Presentation Contexts

The Storage Commitment SCU AE is capable of proposing the Presentation Contexts shown in the following table:

**Table 4.2-16  
PROPOSED PRESENTATION CONTEXTS FOR ACTIVITY COMMIT SENT IMAGES**

Presentation Context Table					
Abstract Syntax		Transfer Syntax		Role	Ext. Neg.
Name	UID	Name List	UID List		
Storage Commitment	1.2.840.10008.1.20.1	Explicit VR Little Endian	1.2.840.10008.1.2.1	SCU	None
Storage Commitment	1.2.840.10008.1.20.1	Implicit VR Little Endian	1.2.840.10008.1.2	SCU	None

A Presentation Context for the Storage Commitment Push Model will only be proposed if the remote AE is configured as an archive device.

#### 4.2.2.3.1.3 SOP Specific Conformance for Storage Commitment SOP Class

##### 4.2.2.3.1.3.1 Storage Commitment Operations (N-ACTION)

The Storage Commitment SCU AE provides standard conformance to the Storage Commitment Service Class as an SCU.

The Storage Commitment SCU AE will send Storage Commitment for instances of the Storage SOP Classes if the remote AE is configured as an archive device and a presentation context for the Storage Commitment Push Model has been accepted.

The behavior of Storage Commitment SCU AE when encountering status codes in an N-ACTION response is summarized in the Table below:

**Table 4.2-17  
STORAGE COMMITMENT N-ACTION RESPONSE STATUS HANDLING BEHAVIOR**

Service Status	Further Meaning	Status Code	Behavior
Success	Success	0000	The request for storage commitment is considered successfully sent.
*	*	Any other Status code.	The Association is aborted and the status is logged and the job incompleteness is reported to the user via the database management application. The Storage Commitment SCU AE will retry the request next time the system start-up.

The behavior of Storage Commitment AE during communication failure is summarized in the Table below:

**Table 4.2-18  
STORAGE COMMITMENT COMMUNICATION FAILURE BEHAVIOR**

Exception	Behavior
Timeout	The Association is aborted and the status is logged and the job incompleteness is reported to the user via the database management application. The Storage Commitment SCU AE will retry the request next time the system start-up.
Association aborted by the SCP or network layers	The status is logged and the job incompleteness is reported to the user via the database management application. The Storage Commitment SCU AE will retry the request next time the system start-up.

## 4.2.2.4 Association Acceptance Policy

### 4.2.2.4.1 Activity – Receive Storage Commitment Response

#### 4.2.2.4.1.1 Description and Sequencing of Activities

The Storage Commitment SCU AE will accept Associations in order to receive responses to a Storage Commitment Request.

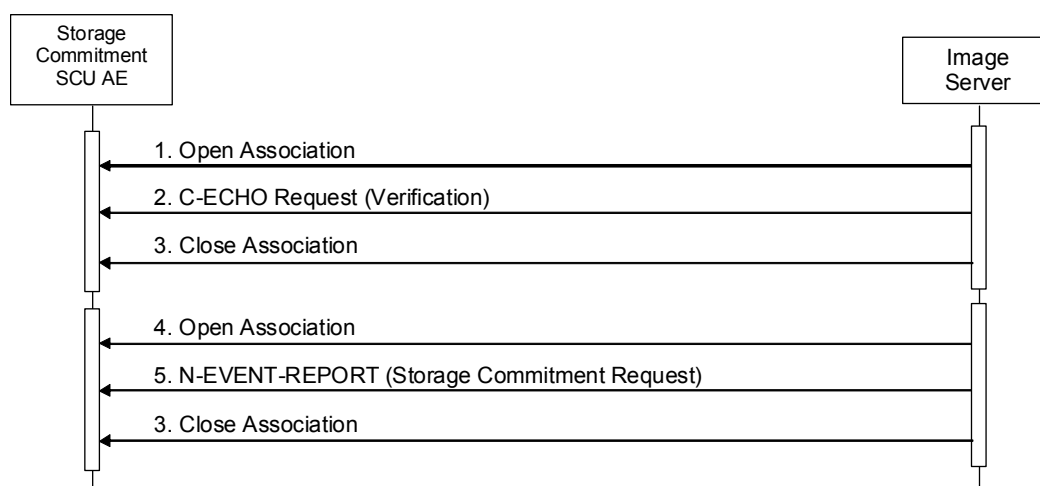

**Figure 4.2-3**  
**SEQUENCING OF ACTIVITY - RECEIVE STORAGE COMMITMENT RESPONSE**

A possible sequence of interactions between the Storage Commitment SCU AE and an Image Server (e.g. a storage or archive device supporting Storage Commitment SOP Classes as an SCP) is illustrated in the Figure above:

1. The Image Server opens an association with the Storage Commitment SCU AE.
2. The Image Server issues a Verification request (C-ECHO), and the Storage Commitment SCU AE replies with a C-ECHO response (status success).
3. The Image Server closes the association with the Storage Commitment SCU AE.
4. The Image Server opens an association with the Storage Commitment SCU AE.
5. The Image Server sends an N-EVENT-REPORT request notifying the Storage Commitment SCU AE of the status of a previous Storage Commitment Request. The Storage Commitment SCU AE replies with an N-EVENT-REPORT response confirming receipt.
6. The Image Server closes the association with the Storage Commitment SCU AE.

The Storage Commitment SCU AE may reject Association attempts as shown in the Table below. The Result, Source and Reason/Diag columns represent the values returned in the appropriate fields of an ASSOCIATE-RJ PDU (see PS 3.8, Section 9.3.4).

**Table 4.2-19  
ASSOCIATION REJECTION REASONS**

<b>Result</b>	<b>Source</b>	<b>Reason/Diag</b>	<b>Explanation</b>
2 – rejected-transient	DICOM UL service-provider (Presentation related function)	2 – local-limit-exceeded	The (configurable) maximum number of simultaneous Associations has been reached. An Association request with the same parameters may succeed at a later time.
1 – rejected-permanent	DICOM UL service-user	3 – called-AE-title-not-r ecognized	The Association request contained an unrecognized Called AE Title. An Association request with the same parameters will not succeed at a later time unless configuration changes are made. This rejection reason normally occurs when the Association initiator is incorrectly configured and attempts to address the Association acceptor using the wrong AE Title.
1 – rejected-permanent	DICOM UL service-provider (ASCE related function)	1 – no-reason-given	The Association request could not be parsed. An Association request with the same format will not succeed at a later time.

#### 4.2.2.4.1.2 Accepted Presentation Contexts

The Storage Commitment SCU AE will accept Presentation Contexts as shown in the Table below.

**Table 4.2-20  
ACCEPTABLE PRESENTATION CONTEXTS FOR  
ACTIVITY RECEIVE STORAGE COMMITMENT RESPONSE**

<b>Presentation Context Table</b>					
<b>Abstract Syntax</b>		<b>SOP Class UID</b>		<b>Role</b>	<b>Ext. Neg.</b>
<b>Name</b>	<b>UID</b>	<b>Name List</b>	<b>UID List</b>		
Verification	1.2.840.10008.1.1	Explicit VR Little Endian	1.2.840.10008.1.2.1	SCP	None
Verification	1.2.840.10008.1.1	Implicit VR Little Endian	1.2.840.10008.1.2	SCP	None
Storage Commitment Push Model	1.2.840.10008.1.20.1	Explicit VR Little Endian	1.2.840.10008.1.2.1	SCU	None
Storage Commitment Push Model	1.2.840.10008.1.20.1	Implicit VR Little Endian	1.2.840.10008.1.2	SCU	None

#### 4.2.2.4.1.3 SOP Specific Conformance for Storage Commitment SOP Class

##### 4.2.2.4.1.3.1 Storage Commitment Notifications (N-EVENT-REPORT)

The Storage Commitment SCU AE provides standard conformance to the Storage Commitment Service Class as an SCU.

The behavior of Storage Commitment SCU AE when receiving Event Types within the N-EVENT-REPORT is summarized in the Table below.

**Table 4.2-21  
STORAGE COMMITMENT N-EVENT-REPORT BEHAVIOR**

Event Type Name Event	Type ID	Behavior
Storage Commitment Request Successful	1	The Storage Commitment SCU AE permits the operator(s) to delete the Referenced SOP Instances under Referenced SOP Sequence (0008,1199). Also successfully committed SOP Instances are candidates for automatic deletion from the local database if local resources become scarce.
Storage Commitment Request Complete – Failures Exist	2	The Referenced SOP Instances under Referenced SOP Sequence (0008,1199) are treated in the same way as in the success case (Event Type 1). The Referenced SOP Instances under Failed SOP Sequence (0008,1198) are marked within the database as Commitment Failure. The Failure Reasons are logged and the job incompleteness is reported to the user via the database management application. The Storage Commitment SCU AE will retry the request next time the system start-up.

The reasons for returning specific status codes in an N-EVENT-REPORT response are summarized in the Table below.

**Table 4.2-22  
STORAGE COMMITMENT N-EVENT-REPORT RESPONSE STATUS REASONS**

Service Status	Further Meaning	Status Code	Reasons
Success	Success	0000	The storage commitment result has been successfully received.

#### 4.2.2.4.1.4 SOP Specific Conformance for Verification SOP Class

The Storage Commitment SCU AE provides standard conformance to the Verification SOP Class as an SCP.

## 4.2.3 MWM SCU AE Specification

### 4.2.3.1 SOP Classes

The MWM SCU AE provides Standard Conformance to the following SOP Classes:

**Table 4.2-23**  
**SOP CLASSES FOR THE MWM SCU AE**

SOP Class Name	SOP Class UID	SCU	SCP
Modality Worklist Information Model – FIND	1.2.840.10008.5.1.4.31	Yes	No

### 4.2.3.2 Association Policies

#### 4.2.3.2.1 General

The DICOM standard application context name for DICOM 3.0 is always proposed:

**Table 4.2-24**  
**DICOM APPLICATION CONTEXT FOR THE MWM SCU AE**

Application Context Name	1.2.840.10008.3.1.1.1
--------------------------	-----------------------

#### 4.2.3.2.2 Number of Associations

The MWM SCU AE initiates one Association at a time for a Worklist request.

**Table 4.2-25**  
**NUMBER OF ASSOCIATIONS INITIATED FOR THE MWM SCU AE**

Maximum number of simultaneous Associations	1
---	---

#### 4.2.3.2.3 Asynchronous Nature

The MWM SCU AE does not support asynchronous communication (multiple outstanding transactions over a single Association).

**Table 4.2-26**  
**ASYNCHRONOUS NATURE FOR THE MWM SCU AE**

Maximum number of outstanding asynchronous transactions	1
---	---

#### 4.2.3.2.4 Implementation Identifying Information

The implementation information for this Application Entity is:

**Table 4.2-27**  
**DICOM IMPLEMENTATION CLASS AND VERSION FOR THE MWM SCU AE**

Implementation Class UID	1.2.392.200036.9116.39.1.1
Implementation Version Name	MGU1000D_V220

### 4.2.3.3 Association Initiation Policy

#### 4.2.3.3.1 Activity – Update Worklist

##### 4.2.3.3.1.1 Description and Sequencing of Activities

The request for an “Update Worklist” is initiated by user interaction, i.e. pressing the buttons “Refresh” or automatically at the time of patient registration.

Upon initiation of the request, the MWM SCU AE will build an Identifier for the C-FIND request, will initiate an Association to send the request and will wait for Worklist responses. After retrieval of all responses, the MWM SCU AE will access the local database to add or update patient demographic data. The results will be displayed in a separate list.

The MWM SCU AE will initiate an Association in order to issue a C-FIND request according to the Modality Worklist Information Model.

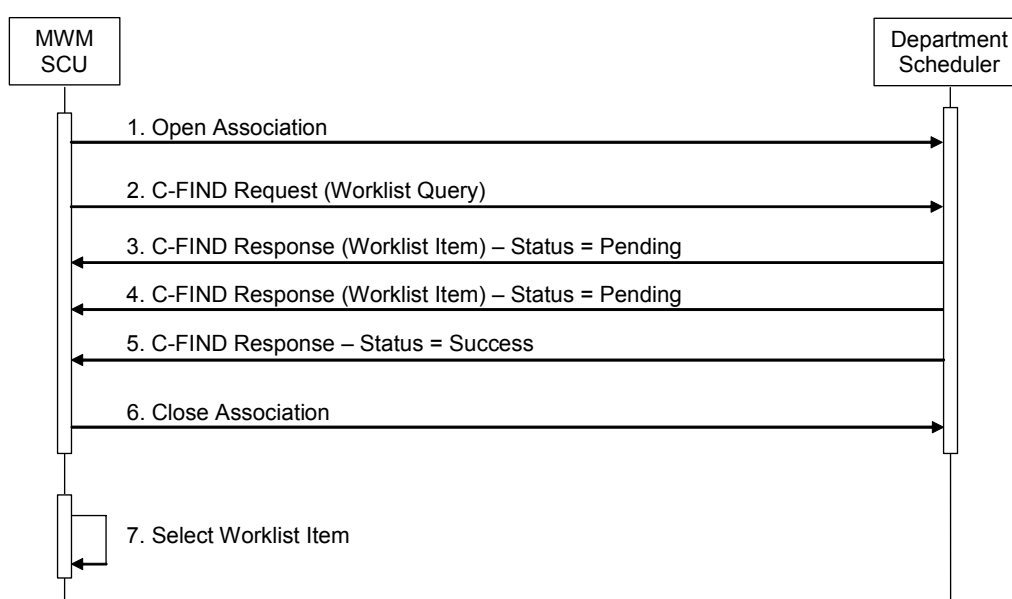

**Figure 4.2-4**  
**SEQUENCING OF ACTIVITY – UPDATE WORKLIST**

A possible sequence of interactions between the MWM SCU AE and a Department Scheduler (e.g. a device such as a RIS or HIS which supports the Modality Worklist SOP Class as an SCP) is illustrated in the Figure above:

1. The MWM SCU AE opens an association with the Department Scheduler
2. The MWM SCU AE sends a C-FIND request to the Department Scheduler containing the Worklist Query attributes.
3. The Department Scheduler returns a C-FIND response containing the requested attributes of the first matching Worklist Item.
4. The Department Scheduler returns another C-FIND response containing the requested attributes of the second matching Worklist Item.
5. The Department Scheduler returns another C-FIND response with status Success indicating that no further matching Worklist Items exist. This example assumes that only 2 Worklist items match the Worklist Query.
6. The MWM SCU AE closes the association with the Department Scheduler.
7. The user selects a Worklist Item from the Worklist and prepares to acquire new images.

#### 4.2.3.3.1.2 Proposed Presentation Contexts

The MWM SCU AE will propose Presentation Contexts as shown in the following table:

**Table 4.2-28  
Proposed Presentation Contexts for Activity Update Worklist**

Presentation Context Table					
Abstract Syntax		Transfer Syntax		Role	Ext. Neg.
Name	UID	Name List	UID List		
Modality Worklist Information Model – FIND	1.2.840.10008.5.1.4.31	Explicit VR Little Endian	1.2.840.10008.1.2.1	SCU	None
Modality Worklist Information Model – FIND	1.2.840.10008.5.1.4.31	Implicit VR Little Endian	1.2.840.10008.1.2	SCU	None

#### 4.2.3.3.1.3 SOP Specific Conformance for Modality Worklist SOP Class

The MWM SCU AE provides standard conformance to the Modality Worklist SOP Class as an SCU.

The behavior of the MWM SCU when encountering status codes in a Modality Worklist C-FIND response is summarized in the table below.

**Table 4.2-29  
Modality Worklist C-FIND Response Status Handling Behavior**

Service Status	Further Meaning	Status Code	Behavior
Success	Matching is complete	0000	The SCP has completed the matches. Worklist items are available for display or further processing.
Refused	Out of Resources	A700H	The Association is aborted using A-ABORT and the worklist is empty. The status meaning is logged.
Failed	Identifier does not match SOP Class	A900H	
Failed	Unable to Process	CxxxH	
Cancel	Matching terminated due to Cancel request	FE00H	If the query was cancelled due to too many worklist items then the SCP has completed the matches. Worklist items are available for display or further processing. The status meaning is logged.
Pending	Matches are continuing	FF00H	The worklist item contained in the Identifier is collected for later display or further processing.
Pending	Matches are continuing – Warning that one or more Optional Keys were not supported	FF01H	
*	*	Any other status code.	The Association is aborted using A-ABORT and the worklist is empty. The status meaning is logged.



The behavior of the MWM SCU AE during communication failure is summarized in the table below.

**Table 4.2-30  
MODALITY WORKLIST COMMUNICATION FAILURE BEHAVIOR**

Exception	Behavior
Timeout	The Association is aborted using A-ABORT and the worklist is empty. The reason is logged.
Association aborted by the SCP or network layers	The worklist is empty and the reason is logged.

Acquired images will always use the Study Instance UID specified for the Scheduled Procedure Step (if available). If an acquisition is unscheduled, a Study Instance UID will be generated locally.

The table below provides a description of the MWM SCU AE Worklist Request Identifier and specifies the attributes that are copied into the images. Unexpected attributes returned in a C-FIND response are ignored.

**Table 4.2-31  
WORKLIST REQUEST IDENTIFIER**

Module Name Attribute Name	Tag	VR	M	R	D	IOD
SOP Common						
Specific Character Set	(0008,0005)	CS		x		x
Scheduled Procedure Step						
Scheduled Procedure Step Sequence	(0040,0100)	SQ		x		
> Modality	(0008,0060)	CS	S			x
> Requested Contrast Agent	(0032,1070)	LO		x		
> Scheduled Station AE Title	(0040,0001)	AE	S			x
> Scheduled Procedure Step Start Date	(0040,0002)	DA	S		x	
> Scheduled Procedure Step Start Time	(0040,0003)	TM		x		
> Scheduled Performing Physician's Name	(0040,0006)	PN		x		
> Scheduled Procedure Step Description	(0040,0007)	SH		x	x	x
> Scheduled Protocol Code Sequence	(0040,0008)	SQ		x		
>> Code value	(0008,0100)	SH		x		
>> Coding Scheme Designator	(0008,0102)	SH		x		
>> Coding Scheme Version	(0008,0103)	SH		x		
>> Code Meaning	(0008,0104)	LO		x		
> Scheduled Procedure Step ID	(0040,0009)	SH		x		
> Scheduled Station Name	(0040,0010)	LO		x		
> Scheduled Procedure Step Location	(0040,0011)	SH		x		
> Pre-Medication	(0040,0012)	LO		x		
> Comments on Scheduled Procedure Step	(0040,0400)	LT		x		
Requested Procedure						
Study Instance UID	(0020,000D)	UI		x		x
Requested Procedure Description	(0032,1060)	LO		x		
Requested Procedure Code Sequence	(0032,1064)	SQ		x		
> Code value	(0008,0100)	SH		x		
> Coding Scheme Designator	(0008,0102)	SH		x		
> Coding Scheme Version	(0008,0103)	SH		x		
> Code Meaning	(0008,0104)	LO		x		
Requested Procedure ID	(0040,1001)	SH		x		
Requested Procedure Priority	(0040,1003)	SH		x		
Patient Transport Arrangements	(0040,1004)	LO		x		
Requested Procedure Location	(0040,1005)	LO		x		
Requested Procedure Comments	(0040,1400)	LT		x		
Imaging Service Request						
Accession Number	(0008,0050)	DA		x	x	x
Visit Status						
Current Patient Location	(0038,0300)	LO		x		

Module Name Attribute Name	Tag	VR	M	R	D	IOD
Patient Identification						
Patient's Name	(0010,0010)	PN		x	x	x
Patient ID	(0010,0020)	LO		x	x	x
Patient Demographic						
Patient Data Confidentiality Constraint Description	(0040,3001)	LO		x		
Patient's Birth Date	(0010,0030)	DA		x	x	x
Patient's Sex	(0010,0040)	CS		x	x	x
Patient's Weight	(0010,1030)	DS		x		
Patient Comments	(0010,4000)	LT		x	x	x
Patient Medical						
Medical Alerts	(0010,2000)	LO		x		
Contrast Allergies	(0010,2110)	LO		x		
Pregnancy Status	(0010,21C0)	US		x		
Special Needs	(0038,0050)	LO		x		
Patient State	(0038,0500)	LO		x		

The above table should be read as follows:

- Module Name: The name of the associated module for supported worklist attributes.
- Attribute Name: Attributes supported to build the MWM SCU AE Worklist Request Identifier.
- Tag: DICOM tag for this attribute.
- VR: DICOM VR for this attribute.
- M: Matching keys for (automatic) Worklist Update. An "S" will indicate that the MWM SCU AE will supply an attribute value for Single Value Matching.
- R: Return keys. An "x" will indicate that the MWM SCU AE will supply this attribute as Return Key with zero length for Universal Matching.
- D: Displayed keys. An "x" indicates that this worklist attribute is displayed to the user during a patient selection. For example, Patient Name will be displayed when selecting the patient prior to an examination.
- IOD: An "x" indicates that this Worklist attribute is included into all Object Instances created during performance of the related Procedure Step.

The default Query Configuration is set to "Modality" (MG), "Date" (date of today) and own AET.

#### 4.2.3.4 Association Acceptance Policy

The MWM SCU AE does not accept Associations.

## 4.2.4 MPPS SCU AE Specification

### 4.2.4.1 SOP Classes

The MPPS SCU AE provides Standard Conformance to the following SOP Classes:

**Table 4.2-32**  
**SOP CLASSES FOR THE MPPS SCU AE**

SOP Class Name	SOP Class UID	SCU	SCP
Modality Performed Procedure Step	1.2.840.10008.3.1.2.3.3	Yes	No

### 4.2.4.2 Association Policies

#### 4.2.4.2.1 General

The DICOM standard application context name for DICOM 3.0 is always proposed:

**Table 4.2-33**  
**DICOM APPLICATION CONTEXT FOR THE MPPS SCU AE**

Application Context Name	1.2.840.10008.3.1.1.1
--------------------------	-----------------------

#### 4.2.4.2.2 Number of Associations

The MPPS SCU AE initiates one Association at a time.

**Table 4.2-34**  
**NUMBER OF ASSOCIATIONS INITIATED FOR THE MPPS SCU AE**

Maximum number of simultaneous Associations	1
---	---

#### 4.2.4.2.3 Asynchronous Nature

The MPPS SCU AE does not support asynchronous communication (multiple outstanding transactions over a single Association).

**Table 4.2-35**  
**ASYNCHRONOUS NATURE FOR THE MPPS SCU AE**

Maximum number of outstanding asynchronous transactions	1
---	---

#### 4.2.4.2.4 Implementation Identifying Information

The implementation information for this Application Entity is:

**Table 4.2-36**  
**DICOM IMPLEMENTATION CLASS AND VERSION FOR THE MPPS SCU AE**

Implementation Class UID	1.2.392.200036.9116.39.1.1
Implementation Version Name	MGU1000D_V220

### 4.2.4.3 Association Initiation Policy

#### 4.2.4.3.1 Activity – Acquire Images

##### 4.2.4.3.1.1 Description and Sequencing of Activities

After the user selects Patient and starts the study, the MPPS SCU AE is awaiting the 1st acquisition of images. The trigger to create a MPPS SOP Instance is derived from this event. An Association to the configured MPPS SCP system is established immediately and the related MPPS SOP Instance will be created.

Further updates on the MPPS data can be performed when the user completes the study.

The MPPS SCU AE will initiate an Association to issue an:

- N-CREATE request according to the CREATE Modality Performed Procedure Step SOP Instance operation, or an:
- N-SET request to update the contents and state of the MPPS according to the SET Modality Performed Procedure Step Information operation.

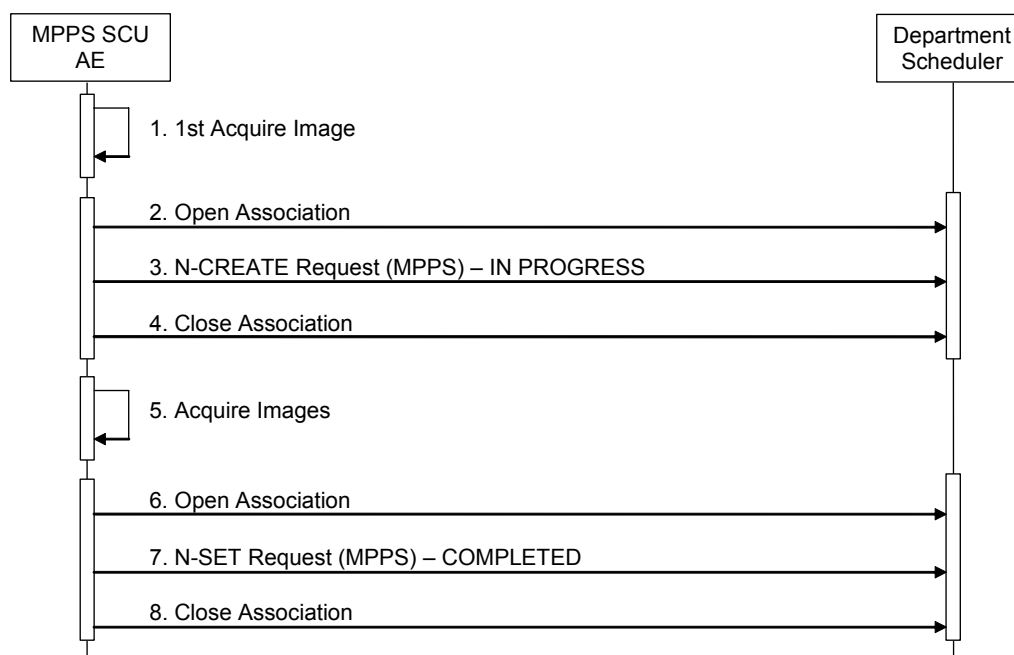

**Figure 4.2-5**  
**SEQUENCING OF ACTIVITY – ACQUIRE IMAGES**

A possible sequence of interactions between the MPPS SCU AE and a Department Scheduler (e.g. a device such as a RIS or HIS which supports the MPPS SOP Class as an SCP) is illustrated in the Figure above:

1. 1st image is acquired and stored in the local database.
2. The MPPS SCU AE opens an association with the Department Scheduler
3. The MPPS SCU AE sends an N-CREATE request to the Department Scheduler to create an MPPS instance with status of “IN PROGRESS” and create all necessary attributes. The Department Scheduler acknowledges the MPPS creation with an N-CREATE response (status success).
4. The MPPS SCU AE closes the association with the Department Scheduler.
5. All images are acquired and stored in the local database.

6. The MPPS SCU AE opens an association with the Department Scheduler.
7. The MPPS SCU AE sends an N-SET request to the Department Scheduler to update the MPPS instance with status of "COMPLETED" and set all necessary attributes. The Department Scheduler acknowledges the MPPS update with an N-SET response (status success).
8. The MPPS SCU AE closes the association with the Department Scheduler.

#### 4.2.4.3.1.2 Proposed Presentation Contexts

The MPPS SCU AE will propose Presentation Contexts as shown in the following table:

**Table 4.2-37  
PROPOSED PRESENTATION CONTEXTS FOR REAL-WORLD ACTIVITY ACQUIRE IMAGES**

Presentation Context Table					
Abstract Syntax		Transfer Syntax		Role	Ext. Neg.
Name	UID	Name List	UID List		
Modality Performed Procedure Step	1.2.840.10008.3.1.2.3.3	Explicit VR Little Endian	1.2.840.10008.1.2.1	SCU	None
Modality Performed Procedure Step	1.2.840.10008.3.1.2.3.3	Implicit VR Little Endian	1.2.840.10008.1.2	SCU	None

#### 4.2.4.3.1.3 SOP Specific Conformance for MPPS SOP Class

The MPPS SCU AE provides standard conformance to the Modality Performed Procedure Step SOP Class as an SCU.

The behavior of the MPPS SCU AE when encountering status codes in an MPPS N-CREATE or N-SET response is summarized in the table below.

**Table 4.2-38  
MPPS N-CREATE / N-SET RESPONSE STATUS HANDLING BEHAVIOR**

Service Status	Further Meaning	Status Code	Behavior
Success	Success	0000	The SCP has completed the operation successfully.  The Association is aborted and the MPPS is marked as failed. The status meaning is logged and reported to the user.
Failure	Processing Failure – Performed Procedure Step Object may no longer be updated	0110H	
Warning	Attribute Value Out of Range	0116H	
*	*	Any other status code.	

The behavior of the MPPS SCU AE during communication failure is summarized in the table below:

**Table 4.2-39  
MPPS COMMUNICATION FAILURE BEHAVIOR**

Exception	Behavior
Timeout	The Association is aborted and the MPPS is marked as failed. The reason is logged and reported to the user.
Association aborted by the SCP or network layers	The MPPS is marked as failed. The reason is logged and reported to the user.

The table below provides a description of the MPPS N-CREATE and N-SET request identifiers sent by the MPPS SCU AE. Empty cells in the N-CREATE and N-SET columns indicate that the attribute is not sent. An "x" indicates that an appropriate value will be sent. A "Zero length" attribute will be sent with zero length.

**Table 4.2-40  
MPPS N-CREATE / N-SET REQUEST IDENTIFIER**

Attribute Name	Tag	VR	N-CREATE	N-SET
Specific Character Set	(0008,0005)	CS	Created, if an extended or replacement character set is used.	
Modality	(0008,0060)	CS	MG	
Procedure Code Sequence	(0008,1032)	SQ	Zero item	
Referenced Patient Sequence	(0008,1120)	SQ	Zero length	
Patient's Name	(0010,0010)	PN	From Modality Worklist	
Patient ID	(0010,0020)	LO	From Modality Worklist	
Patient's Birth Date	(0010,0030)	DA	From Modality Worklist	
Patient's Sex	(0010,0040)	CS	From Modality Worklist	
Study ID	(0020,0010)	SH	x	
Performed Station AE Title	(0040,0241)	AE	Local AE Title	
Performed Station Name	(0040,0242)	SH	Zero length	
Performed Location	(0040,0243)	SH	Zero length	
Performed Procedure Step Start Date	(0040,0244)	DA	Actual start date	
Performed Procedure Step Start Time	(0040,0245)	TM	Actual start time	
Performed Procedure Step End Date	(0040,0250)	DA	Zero length	x
Performed Procedure Step End Time	(0040,0251)	TM	Zero length	x
Performed Procedure Step Status	(0040,0252)	CS	IN PROGRESS	COMPLETED
Performed Procedure Step ID	(0040,0253)	SH	From Modality Worklist	
Performed Procedure Step Description	(0040,0254)	LO	From Modality Worklist	From Modality Worklist
Performed Procedure Type Description	(0040,0255)	LO	From Modality Worklist	From Modality Worklist
Performed Protocol Code Sequence	(0040,0260)	SQ	Zero item	Zero or more items
> Code Value	(0008,0100)	SH		x
> Coding Scheme Designator	(0008,0102)	SH		x
> Coding Scheme Version	(0008,0103)	SH		x
> Code Meaning	(0008,0104)	LO		x
Scheduled Step Attributes Sequence	(0040,0270)	SQ	One or more items	
> Accession Number	(0008,0050)	SH	From Modality Worklist	
> Referenced Study Sequence	(0008,1110)	SQ	Zero length	
> Study Instance UID	(0020,000D)	UI	From Modality Worklist	
> Requested Procedure Description	(0032,1060)	LO	From Modality Worklist	
> Scheduled Procedure Step Description	(0040,0007)	LO	From Modality Worklist	
> Scheduled Protocol Code Sequence	(0040,0008)	SQ	Zero or more items	
>> Code Value	(0008,0100)	SH	From Modality Worklist	
>> Coding Scheme Designator	(0008,0102)	SH	From Modality Worklist	
>> Coding Scheme Version	(0008,0103)	SH	From Modality Worklist	
>> Code Meaning	(0008,0104)	LO	From Modality Worklist	
> Scheduled Procedure Step ID	(0040,0009)	SH	From Modality Worklist	
> Requested Procedure ID	(0040,1001)	SH	From Modality Worklist	
Total Number of Exposures	(0040,0301)	US	Zero length	x

Attribute Name	Tag	VR	N-CREATE	N-SET
Exposure Dose Sequence	(0040,030E)	SQ	Zero item	Zero or more items
> KVP	(0018,0060)	DS		x
> Exposure Time	(0018,1150)	IS		x
> X-ray Tube Current in $\mu$ A	(0018,8151)	IS		x
> Private creator code	(7099,00xx)	LO		TOSHIBA_MEC_MG3
> Entrance Skin Exposure in mGy	(7099,xx05)	DS		x
> Average Glandular Dose in mGy	(7099,xx06)	DS		x
Performed Series Sequence	(0040,0340)	SQ	Zero length	One item
> Retrieve AE Title	(0008,0054)	AE		Zero length
> Series Description	(0008,103E)	LO		Zero length
> Performing Physician's Name	(0008,1050)	PN		x
> Operators' Name	(0008,1070)	PN		x
> Referenced Image Sequence	(0008,1140)	SQ		One or more items
>> Referenced SOP Class UID	(0008,1150)	UI		x
>> Referenced SOP Instance UID	(0008,1155)	UI		x
> Protocol Name	(0018,1030)	LO		x
> Series Instance UID	(0020,000E)	UI		x
> Referenced Non-Image Composite SOP Instance Sequence	(0040,0220)	SQ		Zero length
Private creator code	(7099,00xx)	LO	TOSHIBA_MEC_MG3	TOSHIBA_MEC_MG3
Radiation Status Sequence	(7099,xx00)	SQ	Zero item	Zero or more items
> Miss Shot Status	(7099,xx02)	CS		NORMAL indicates Normal shot image. MISS indicates Miss shot image.
> Re-exposure Status	(7099,xx03)	CS		NORMAL indicate Active image. AGAIN indicates Non-active image when there are several images of same position and direction.
> Order Status	(7099,xx04)	CS		ORDERED indicates the image ordered by MWM. NON-ORDERED indicates the image that was not ordered by MWM.

#### 4.2.4.4 Association Acceptance Policy

The MPPS SCU AE does not accept Associations.

## 4.2.5 Print SCU AE Specification

### 4.2.5.1 SOP Classes

The Print SCU AE provides Standard Conformance to the following Meta SOP Classes:

**Table 4.2-41  
META SOP CLASSES FOR THE PRINT SCU AE**

SOP Class Name	SOP Class UID	SCU	SCP
Basic Grayscale Print Management Meta	1.2.840.10008.5.1.1.9	Yes	No

The above Meta SOP Classes are defined by the following set of supported SOP Classes:

**Table 4.2-42  
SOP CLASSES FOR THE PRINT SCU AE**

SOP Class Name	SOP Class UID	SCU	SCP
Basic Film Session SOP Class	1.2.840.10008.5.1.1.1	Yes	No
Basic Film Box SOP Class	1.2.840.10008.5.1.1.2	Yes	No
Basic Grayscale Image Box SOP Class	1.2.840.10008.5.1.1.4	Yes	No
Printer SOP Class	1.2.840.10008.5.1.1.16	Yes	No

### 4.2.5.2 Association Policies

#### 4.2.5.2.1 General

The DICOM standard application context name for DICOM 3.0 is always proposed:

**Table 4.2-43  
DICOM APPLICATION CONTEXT FOR THE PRINT SCU AE**

Application Context Name	1.2.840.10008.3.1.1.1
--------------------------	-----------------------

#### 4.2.5.2.2 Number of Associations

The Print SCU AE can initiate one Association at a time for each destination to which a transfer request is being processed in the active job queue list. Only one job will be active at a time, the other remains pending until the active job is completed or failed.

**Table 4.2-44  
NUMBER OF ASSOCIATIONS INITIATED FOR THE PRINT SCU AE**

Maximum number of simultaneous Associations	1
---	---

#### 4.2.5.2.3 Asynchronous Nature

The Print SCU AE does not support asynchronous communication (multiple outstanding transactions over a single Association).

**Table 4.2-45  
ASYNCHRONOUS NATURE FOR THE PRINT SCU AE**

Maximum number of outstanding asynchronous transactions	1
---	---



**4.2.5.2.4 Implementation Identifying Information**

The implementation information for the Print SCU AE is:

**Table 4.2-46  
DICOM IMPLEMENTATION CLASS AND VERSION FOR THE PRINT SCU AE**

Implementation Class UID	1.2.392.200036.9116.39.1.1
Implementation Version Name	MGU1000D_V220

### 4.2.5.3 Association Initiation Policy

#### 4.2.5.3.1 Activity – Send Images & Print Management Information

##### 4.2.5.3.1.1 Description and Sequencing of Activities

##### 4.2.5.3.1.1.1 Send Images & Print Management Information

A user composes images onto film sheets and requests them to be sent to a specific hardcopy device. The user can select the desired film size.

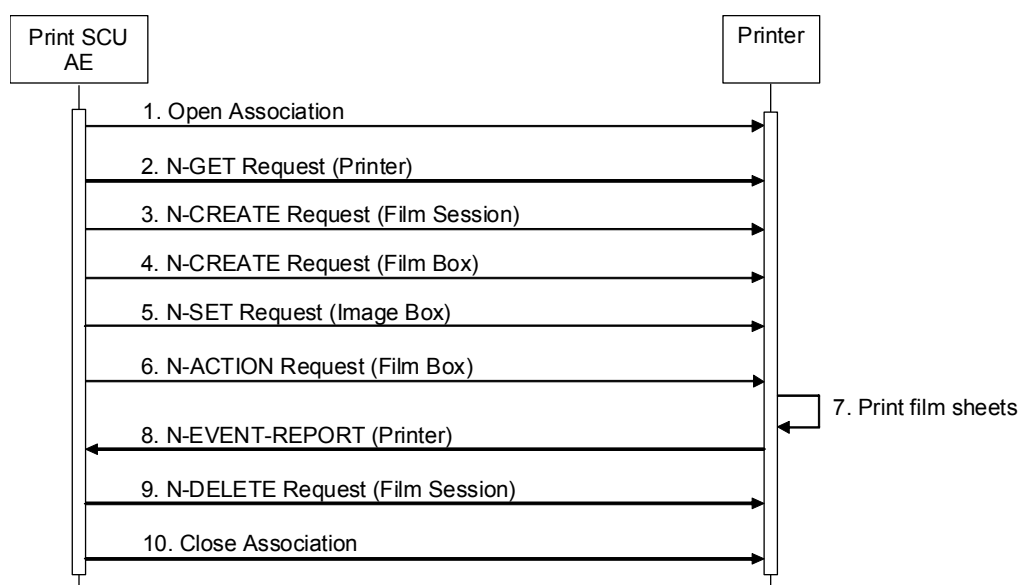

**Figure 4.2-6**  
**SEQUENCING OF ACTIVITY – SEND IMAGES & PRINT MANAGEMENT INFORMATION**

A typical sequence of DIMSE messages sent over an association between the Print SCU AE and a Printer is illustrated in the Figure above:

1. The Print SCU AE opens an Association with the Printer.
2. N-GET on the Printer SOP Class is used to obtain current printer status information. If the Printer reports a status of FAILURE, the Print SCU closes the Association and waits and retries from the beginning.
3. N-CREATE on the Film Session SOP Class creates a Film Session.
4. N-CREATE on the Film Box SOP Class creates a Film Box linked to the Film Session.
5. N-SET on the Image Box SOP Class transfers the contents of the film sheet to the printer.
6. N-ACTION on the Film Box SOP Class instructs the Printer to print the Film Box.
7. The printer prints the requested number of film sheets.
8. The Printer asynchronously reports its status via N-EVENT-REPORT notification (Printer SOP Class). The printer can send this message at any time. The Print SCU AE does not require the N-EVENT-REPORT to be sent. The Print SCU AE is capable of receiving an N-EVENT-REPORT notification at any time during an association. If the Printer reports a status of FAILURE, the print-job is switched to a failed state and the user informed.
9. N-DELETE on the Film Session SOP Class deletes the complete Film Session SOP Instance hierarchy.
10. The Print SCU AE closes the Association with the Printer.

**4.2.5.3.1.1.2 Polling**

The Print SCU AE automatically obtains current printer status information periodically (default; every 2 minutes; configurable using the Service Tool by the Field Service Engineer). The printer status information is reported to the user.

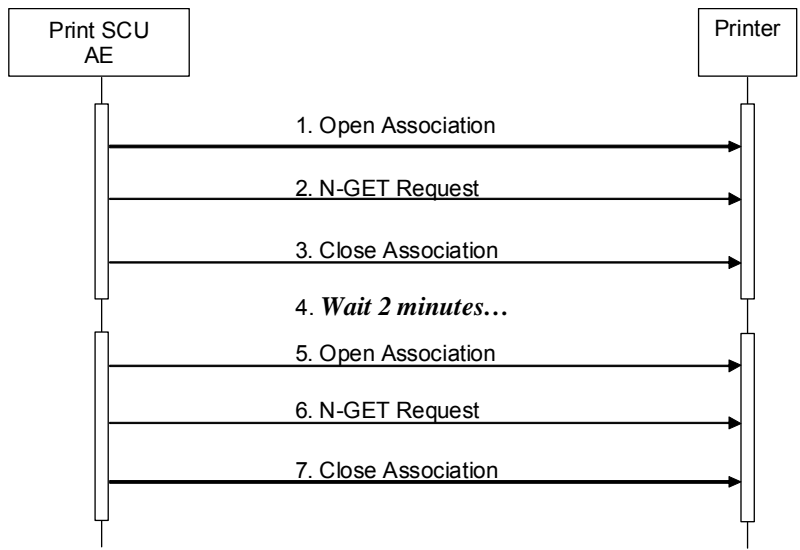

**Figure 4.2-7  
SEQUENCING OF ACTIVITY – POLLING**

A typical sequence of DIMSE messages sent over an association between the Print SCU AE and a Printer is illustrated in the Figure above:

1. The Print SCU AE opens an Association with the Printer.
2. N-GET on the Printer SOP Class is used to obtain current printer status information.
3. The Print SCU AE closes the Association with the Printer.
4. The Print SCU AE waits 1 minute.

The Print SCU AE repeats 1-4.

**4.2.5.3.1.2 Proposed Presentation Contexts**

The Print SCU AE is capable of proposing the Presentation Contexts shown in the table below:

**Table 4.2-47  
PROPOSED PRESENTATION CONTEXTS FOR ACTIVITY  
SEND IMAGES & PRINT MANAGEMENT INFORMATION**

Presentation Context Table					
Abstract Syntax		Transfer Syntax		Role	Ext. Neg.
Name	UID	Name List	UID List		
Basic Grayscale Print Management Meta	1.2.840.10008.5.1.1.9	Explicit VR Little Endian	1.2.840.10008.1.2.1	SCU	None
Basic Grayscale Print Management Meta	1.2.840.10008.5.1.1.9	Implicit VR Little Endian	1.2.840.10008.1.2	SCU	None

#### 4.2.5.3.1.3 Common SOP Specific Conformance for all Print SOP Classes

The general behavior of the Print SCU AE during communication failure is summarized in the table below. This behavior is common for all SOP Classes supported by the Print SCU AE.

**Table 4.2-48  
PRINT COMMUNICATION FAILURE BEHAVIOR**

Exception	Behavior
Timeout	The Association is aborted and the print-job is marked as failed. The reason is logged and the job failure is reported to the user via the job control application.
Association aborted by the SCP or network layers	The print-job is marked as failed. The reason is logged and the job failure is reported to the user via the job control application.

#### 4.2.5.3.1.4 SOP Specific Conformance for Printer SOP Class

The Print SCU AE supports the following DIMSE operations and notifications for the Printer SOP Class:

— N-GET

Details of the supported attributes and status handling behavior are described in the following subsections.

##### 4.2.5.3.1.4.1 Printer SOP Class Operations (N-GET)

The Print SCU AE uses the Printer SOP Class N-GET operation to obtain information about the current printer status. The attributes obtained via N-GET are listed in the table below:

**Table 4.2-49  
PRINTER SOP CLASS N-GET REQUEST ATTRIBUTES**

Attribute Name	Tag	VR	Value	Presence of Value	Source
Printer Status	(2110,0010)	CS	Provided by Printer	ALWAYS	Printer
Printer Status Info	(2110,0020)	CS	Provided by Printer	ALWAYS	Printer

The Printer Status information is evaluated as follows:

1. If Printer Status (2110,0010) is NORMAL, "READY" is displayed in the job control application.
2. If Printer Status (2110,0010) is FAILURE or WARNING, "NOT READY" is displayed and the contents of Printer Status Info (2110,0020) is logged.

The behavior of The Print SCU AE when encountering status codes in an N-GET response is summarized in the table below:

**Table 4.2-50  
PRINTER SOP CLASS N-GET RESPONSE STATUS HANDLING BEHAVIOR**

Service Status	Further Meaning	Status Code	Behavior
Success	Success	0000	The request to get printer status information was success.
Warning	Attribute List Error	0107H	The request to get printer status information is considered successful.
*	*	Any other status code.	The Association is aborted and the status meaning is logged and reported to the user.

#### 4.2.5.3.1.5 SOP Specific Conformance for the Film Session SOP Class

The Print SCU AE supports the following DIMSE operations for the Film Session SOP Class:

- N-CREATE
- N-DELETE

Details of the supported attributes and status handling behavior are described in the following subsections.

##### 4.2.5.3.1.5.1 Film Session SOP Class Operations (N-CREATE)

The attributes supplied in an N-CREATE Request are listed in the table below:

**Table 4.2-51  
FILM SESSION SOP CLASS N-CREATE REQUEST ATTRIBUTES**

Attribute Name	Tag	VR	Value	Presence of Value	Source
Number of Copies	(2000,0010)	IS	1	ALWAYS	AUTO
Print Priority	(2000,0020)	CS	HIGH	ALWAYS	AUTO
Medium Type	(2000,0030)	CS	BLUE FILM or CLEAR FILM or MAMMO BLUE FILM	ALWAYS	USER
Film Destination	(2000,0040)	CS	PROCESSOR	ALWAYS	AUTO

The behavior of The Print SCU AE when encountering status codes in an N-CREATE response is summarized in the table below:

**Table 4.2-52  
FILM SESSION SOP CLASS N-CREATE RESPONSE STATUS HANDLING BEHAVIOR**

Service Status	Further Meaning	Status Code	Behavior
Success	Success	0000	The SCP has completed the operation successfully.
Warning	Attribute Value Out of Range	0116H	The N-CREATE operation is considered successful.
Warning	Attribute List Error	0107H	
*	*	Any other status code.	The Association is aborted and the print-job is marked as failed. The status meaning is logged and reported to the user.

##### 4.2.5.3.1.5.2 Film Session SOP Class Operations (N-DELETE)

The behavior of The Print SCU AE when encountering status codes in an N-DELETE response is summarized in the table below:

**Table 4.2-53  
PRINTER SOP CLASS N-DELETE RESPONSE STATUS HANDLING BEHAVIOR**

Service Status	Further Meaning	Status Code	Behavior
Success	Success	0000	The SCP has completed the operation successfully.
*	*	Any other status code.	The Association is aborted and the print-job is marked as failed. The status meaning is logged and reported to the user.

#### 4.2.5.3.1.6 SOP Specific Conformance for the Film Box SOP Class

The Print SCU AE supports the following DIMSE operations for the Film Box SOP Class:

- N-CREATE
- N-ACTION

Details of the supported attributes and status handling behavior are described in the following subsections.

**4.2.5.3.1.6.1 Film Box SOP Class Operations (N-CREATE)**

The attributes supplied in an N-CREATE Request are listed in the table below:

**Table 4.2-54  
FILM BOX SOP CLASS N-CREATE REQUEST ATTRIBUTES**

Attribute Name	Tag	VR	Value	Presence of Value	Source
Image Display Format	(2010,0010)	CS	STANDARD\1,1	ALWAYS	AUTO
Film Orientation	(2010,0040)	CS	PORTRAIT for 8INx10IN LANDSCAPE for 10INX14IN or 11INX14IN	ALWAYS	AUTO
Film Size ID	(2010,0050)	CS	8INX10IN 10INX14IN or 11INX14IN	ALWAYS	USER
Magnification Type	(2010,0060)	CS	CUBIC	ALWAYS	AUTO
Smoothing Type	(2010,0080)	CS	MEDIUM or 2 or NORMAL	ALWAYS	USER
Border Density	(2010,0100)	CS	BLACK	ALWAYS	CONF G
Empty Image Density	(2010,0110)	CS	BLACK	ALWAYS	CONF G
Trim	(2010,0140)	CS	NO	ALWAYS	CONF G
Referenced Film Session Sequence	(2010,0500)	SQ		ALWAYS	AUTO
>Referenced SOP Class UID	(0008,1150)	UI	1.2.840.10008.5.1.1.1	ALWAYS	AUTO
>Referenced SOP Instance UID	(0008,1155)	UI	From created Film Session SOP Instance	ALWAYS	AUTO

The behavior of the Print SCU AE when encountering status codes in an N-CREATE response is summarized in the table below:

**Table 4.2-55  
FILM BOX SOP CLASS N-CREATE RESPONSE STATUS HANDLING BEHAVIOR**

Service Status	Further Meaning	Status Code	Behavior
Success	Success	0000	The SCP has completed the operation successfully.
Warning	Attribute Value Out of Range	0116H	The N-CREATE operation is considered successful.
Warning	Attribute List Error	0107H	
Warning	Requested Min Density or Max Density outside of printer's operating range	B605H	
*	*	Any other status code.	The Association is aborted and the print-job is marked as failed. The status meaning is logged and reported to the user.

#### 4.2.5.3.1.6.2 Film Box SOP Class Operations (N-ACTION)

An N-ACTION Request is issued to instruct the Print SCP to print the contents of the Film Box. The Action Reply argument in an N-ACTION response is not evaluated.

The behavior of The Print SCU AE when encountering status codes in an N-ACTION response is summarized in the table below:

**Table 4.2-56  
FILM BOX SOP CLASS N-ACTION RESPONSE STATUS HANDLING BEHAVIOR**

Service Status	Further Meaning	Status Code	Behavior
Success	Success	0000	The SCP has completed the operation successfully. The film has been accepted for printing.
Warning	Image size is larger than Image Box size. The image has been demagnified.	B604H	The N-ACTION operation is considered successful.
Warning	Image size is larger than Image Box size. The image has been cropped to fit.	B609H	
Warning	Image size or Combined Print Image Size is larger than Image Box size. The image or combined Print Image has been decimated to fit.	B60AH	
Failure	Unable to create Print Job SOP Instance; print queue is full.	C602H	The Association is aborted and the print-job is marked as failed. The status meaning is logged and reported to the user.
Failure	Image size is larger than Image Box size.	C603H	
Failure	Combined Print Image Size is larger than Image Box size.	C613H	
*	*	Any other status code.	

#### 4.2.5.3.1.7 SOP Specific Conformance for the Grayscale Image Box SOP Class

The Print SCU AE supports the following DIMSE operations for the Grayscale Image Box SOP Class:

— N-SET

Details of the supported attributes and status handling behavior are described in the following subsections.

#### 4.2.5.3.1.7.1 Grayscale Image Box SOP Class Operations (N-SET)

The attributes supplied in an N-SET Request are listed in the table below:

**Table 4.2-57  
GRAYSCALE IMAGE BOX SOP CLASS N-SET REQUEST ATTRIBUTES**

Attribute Name	Tag	VR	Value	Presence of Value	Source
Image Position	(2020,0010)	US	1	ALWAYS	AUTO
Basic Grayscale Image Sequence	(2020,0110)	SQ		ALWAYS	AUTO
>Samples Per Pixel	(0028,0002)	US	1	ALWAYS	AUTO
>Photometric Interpretation	(0028,0004)	CS	MONOCHROME2	ALWAYS	AUTO
>Rows	(0028,0010)	US	2816	ALWAYS	AUTO
>Columns	(0028,0011)	US	2016 or 4032	ALWAYS	AUTO
>Pixel Aspect Ratio	(0028,0034)	IS	1\1	ALWAYS	AUTO
>Bits Allocated	(0028,0100)	US	16	ALWAYS	AUTO
>Bits Stored	(0028,0101)	US	12	ALWAYS	AUTO
>High Bit	(0028,0102)	US	11	ALWAYS	AUTO
>Pixel Representation	(0028,0103)	US	0	ALWAYS	AUTO
>Pixel Data	(7FE0,0010)	OW		ALWAYS	AUTO

The behavior of the Print SCU AE when encountering status codes in an N-SET response is summarized in the table below:

**Table 4.2-58  
GRAYSCALE IMAGE BOX SOP CLASS N-SET RESPONSE STATUS HANDLING BEHAVIOR**

Service Status	Further Meaning	Status Code	Behavior
Success	Success	0000	The SCP has completed the operation successfully. Image successfully stored in Image Box.
Warning	Attribute Value Out of Range	0116H	The N-SET operation is considered successful.
Warning	Attribute List Error	0107H	
Warning	Image size is larger than Image Box size. The image has been demagnified.	B604H	
Warning	Requested Min Density or Max Density outside of printer's operating range.	B605H	
Warning	Image size is larger than Image Box size. The image has been cropped to fit.	B609H	
Warning	Image size or Combined Print Image Size is larger than Image Box size. The image or combined Print Image has been decimated to fit.	B60AH	
Failure	Image size is larger than Image Box size.	C603H	The Association is aborted and the print-job is marked as failed. The status meaning is logged and reported to the user.
Failure	Insufficient memory in printer to store the image.	C605H	
Failure	Combined Print Image Size is larger than Image Box size.	C613H	
*	*	Any other status code.	

#### 4.2.5.4 Association Acceptance Policy

The Print SCU AE does not accept Associations.



## 4.2.6 Verification SCU AE Specification

### 4.2.6.1 SOP Classes

The Verification SCU AE provides Standard Conformance to the following SOP Classes:

**Table 4.2-59**  
**SOP CLASSES FOR THE VERIFICATION SCU AE**

SOP Class Name	SOP Class UID	SCU	SCP
Verification	1.2.840.10008.1.1	Yes	No

### 4.2.6.2 Association Policies

#### 4.2.6.2.1 General

The DICOM standard application context name for DICOM 3.0 is always proposed:

**Table 4.2-60**  
**DICOM APPLICATION CONTEXT FOR THE STORAGE SCU AE**

Application Context Name	1.2.840.10008.3.1.1.1
--------------------------	-----------------------

#### 4.2.6.2.2 Number of Associations

The Verification SCU AE can initiate one Association at a time.

**Table 4.2-61**  
**NUMBER OF ASSOCIATIONS INITIATED FOR THE VERIFICATION SCU AE**

Maximum number of simultaneous Associations	1
---	---

#### 4.2.6.2.3 Asynchronous Nature

The Verification SCU AE does not support asynchronous communication (multiple outstanding transactions over a single Association).

**Table 4.2-62**  
**ASYNCHRONOUS NATURE FOR THE VERIFICATION SCU AE**

Maximum number of outstanding asynchronous transactions	1
---	---

#### 4.2.6.2.4 Implementation Identifying Information

The implementation information for the Verification SCU AE is:

**Table 4.2-63**  
**DICOM IMPLEMENTATION CLASS AND VERSION FOR THE VERIFICATION SCU AE**

Implementation Class UID	1.2.392.200036.9116.39.1.1
Implementation Version Name	MGU1000D_V220

### 4.2.6.3 Association Initiation Policy

#### 4.2.6.3.1 Activity – Verify Connectivity

##### 4.2.6.3.1.1 Description and Sequencing of Activities

A user requests to verify the connectivity. Upon this request, the Verification SCU AE attempts to initiate a new Association in order to issue a Verification request (C-ECHO).

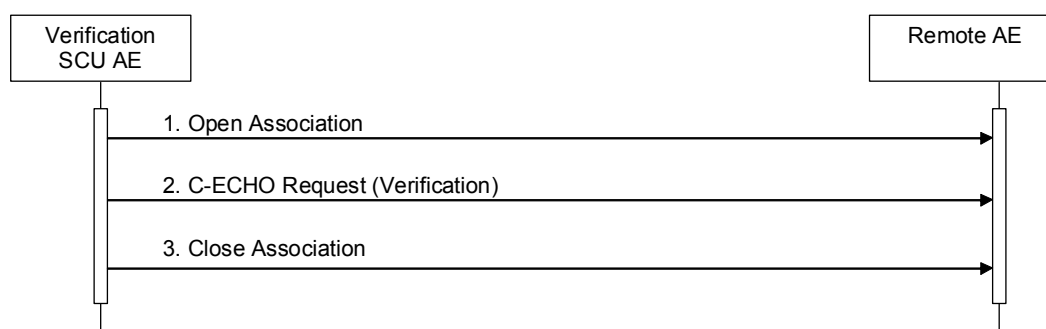
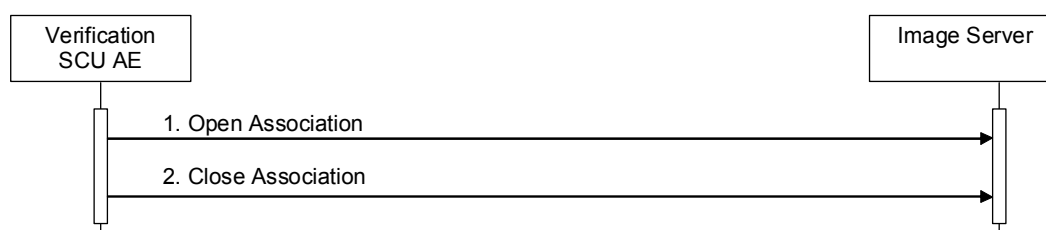

**Figure 4.2-8**  
**SEQUENCING OF ACTIVITY – VERIFY CONNECTIVITY (C-ECHO)**

A possible sequence of interactions between the Verification SCU AE and a remote AE is illustrated in the Figure above:

1. The Verification SCU AE opens an Association with a remote AE.
2. The Verification SCU AE issues a Verification request (C-ECHO) and a remote AE replies with a C-ECHO response (status success).
3. The Verification SCU AE closes the Association with a remote AE.

The local AE also verifies the connectivity to Image Server(s) periodically (default; every 2 minutes; configurable using the Service Tool by the Field Service Engineer). In this case the Verification SCU AE also attempts to initiate a new Association periodically (negotiation) but does not issue a C-ECHO.



**Figure 4.2-9**  
**SEQUENCING OF ACTIVITY – VERIFY CONNECTIVITY (NEGOTIATION)**

A possible sequence of interactions between the Verification SCU AE and a remote AE is illustrated in the Figure above:

1. The Verification SCU AE opens an Association with a remote AE.
2. The Verification SCU AE closes the Association with a remote AE.

#### 4.2.6.3.1.2 Proposed Presentation Contexts

The Verification SCU AE is capable of proposing the Presentation Contexts shown in the following table:

**Table 4.2-64  
PROPOSED PRESENTATION CONTEXTS FOR ACTIVITY VERIFY CONNECTIVITY**

Presentation Context Table					
Abstract Syntax		Transfer Syntax		Role	Ext. Neg.
Name	UID	Name List	UID List		
Verification	1.2.840.10008.1.1	Explicit VR Little Endian	1.2.840.10008.1.2.1	SCU	None
Verification	1.2.840.10008.1.1	Implicit VR Little Endian	1.2.840.10008.1.2	SCU	None

#### SOP Specific Conformance for Verification SOP Classes

The Verification SCU AE provides standard conformance to the Verification Service Class as an SCU.

The behavior of Verification SCU AE when encountering status codes in a C-ECHO response is summarized in the table below:

**Table 4.2-65  
VERIFICATION C-ECHO RESPONSE STATUS HANDLING BEHAVIOR**

Service Status	Further Meaning	Status Code	Behavior
Success	Success	0000	The Verification SCU AE judges the remote AE is present and active on the network.

The behavior of Verification SCU AE during communication failure is summarized in the table below:

**Table 4.2-66  
VERIFICATION COMMUNICATION FAILURE BEHAVIOR**

Exception	Behavior
Timeout	The Association is aborted and the remote AE is marked as failed. The reason is logged and the remote AE failure is reported to the user.
Association aborted by the SCP or network layers	The Association is aborted and the remote AE is marked as failed. The reason is logged and the remote AE failure is reported to the user.

## 4.3 NETWORK INTERFACES

### 4.3.1 Physical Network Interface

This Product supports a single network interface. One of the following physical network interfaces will be available depending on installed hardware options:

**Table 4.3-1  
SUPPORTED PHYSICAL NETWORK INTERFACES**

Ethernet 1000baseT
Ethernet 100baseT
Ethernet 10baseT

### 4.3.2 Additional Protocols

None

## 4.4 CONFIGURATION

### 4.4.1 AE Title/Presentation Address Mapping

#### 4.4.1.1 Local AE Titles

The AE Title that all local applications use is configured using the Utility menu by the user. IP address is configured using the Service Tool by the Field Service Engineer.

**Table 4.4-1  
AE TITLE CONFIGURATION TABLE**

Application Entity	Default AE Title	Default TCP/IP Port
Storage SCU	MGU1000D	Not Applicable
MWM SCU		
MPPS SCU		
Print SCU		
Verification SCU		
Storage Commitment SCU		9104 (For receiving N-EVENT-REPORT)

#### 4.4.1.2 Remote AE Title / Presentation Address Mapping

The AE Titles and port numbers of remote applications are configured using the Utility menu by the user.

## 4.4.2 Parameters

A large number of parameters related to acquisition and general operation can be configured using the Service Tool. The table below only shows those configuration parameters relevant to DICOM communication. See the Product's Service Manual for details on general configuration capabilities.

**Table 4.4-2  
CONFIGURATION PARAMETERS TABLE**

Parameter	Configurable (Yes/No) [Range]	Default Value
<b>General Parameters</b>		
Time-out waiting for a acceptance or rejection response to an Association Request (Application Level Timeout)	No	15 s
Time-out waiting for a response to an Association release request (Application Level Timeout)	No	15 s
Time-out waiting for completion of a TCP/IP connect request (Low-level timeout)	No	15 s
Time-out waiting for data between TCP/IP-packets (Low Level Timeout)	No	15 s
Supported Transfer Syntaxes	No	Explicit VR Little Endian Implicit VR Little Endian
<b>Storage SCU Parameters</b>		
Maximum number of simultaneously initiated Associations by the Storage SCU AE	No	1
Storage SCU time-out waiting for a response to a C-STORE-RQ	No	30 s
Number of times a failed send job may be retried	No	No limited
Delay between retrying failed send jobs	No	60 s
<b>Storage Commitment SCU Parameters</b>		
Maximum number of simultaneously initiated Associations by the Storage Commitment SCU AE	No	1
<b>Modality Worklist SCU Parameters</b>		
Maximum number of simultaneously initiated Associations by the MWM SCU AE	No	1
Modality Worklist SCU time-out waiting for the final response to a C-FIND-RQ	No	300 s
Maximum number of Worklist Items	No	40
Query Worklist for specific Scheduled Station AE Title	Yes [max. 16 characters]	MGU1000D
Query Worklist for specific Modality Value	No	MG
<b>MPPS SCU Parameters</b>		
Maximum number of simultaneously initiated Associations by the MPPS SCU AE	No	1
MPPS SCU time-out waiting for a response to a N-CREATE-RQ	No	30 s
MPPS SCU time-out waiting for a response to a N-SET-RQ	No	30 s
Cycle time to retry when failure	No	5 s
Maximum number of retrying when failure	No	3
<b>Print SCU Parameters</b>		
Maximum number of simultaneously initiated Associations by the Print SCU AE	No	1
Cycle time of polling	YES [1 to 1440 min]	2 min

Parameter	Configurable (Yes/No) [Range]	Default Value
Print SCU time-out waiting for a response to a N-CREATE-RQ	No	30 s
Print SCU time-out waiting for a response to a N-DELETE-RQ	No	30 s
Print SCU time-out waiting for a response to a N-SET-RQ	No	30 s
Print SCU time-out waiting for a response to a N-ACTION-RQ	No	30 s
<b>Verification Parameters</b>		
Cycle time of negotiation to Image Server(s)	YES [1 to 1440 min]	2 min

## 5. MEDIA INTERCHANGE

### 5.1 IMPLEMENTATION MODEL

#### 5.1.1 Application Data Flow

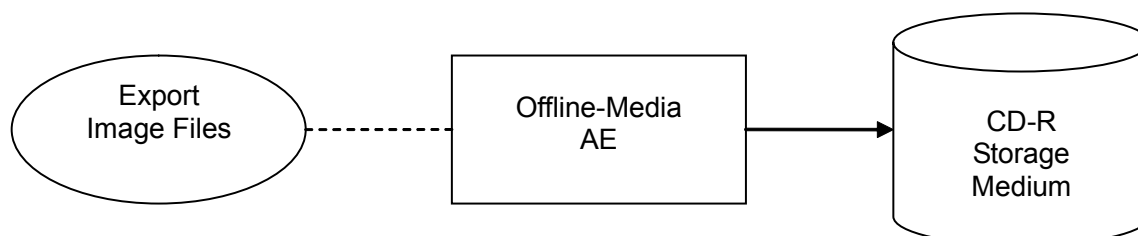

**Figure 5.1-1**  
**APPLICATION DATA FLOW DIAGRAM FOR MEDIA STORAGE**

- The Offline-Media AE exports image files to a CD-R Storage medium. It is associated with the local real-world activity “Export Image Files” performed upon user request.

#### 5.1.2 Functional Definition of AE

##### 5.1.2.1 Functional Definition of Offline-Media AE

The Offline-Media AE is performed upon user request for the selected study to an offline DICOM CD-R medium. It therefore performs the following tasks.

Export:

- Builds DICOM Information Objects.
- Creates a DICOMDIR file that represents the contents of the DICOM Information Objects to be recorded.
- Records DICOM Information Objects and the DICOMDIR file to the CD-R medium.

#### 5.1.3 Sequencing of Real-World Activities

##### 5.1.3.1 Activity – Export Image Files

Operator requests to create new Files-set(s) onto a new CD-R. The requests are executed in the foreground.

The operations for “Export Image Files” are described below:

Step-1: Select the CD-R output application.

Step-2: Select one study on the local storage device to be created to the CD-R medium.

Step-3: Insert the CD media in the device.

Step-4: Request to copy to the CD-R.

## 5.1.4 File Meta Information for Implementation Class and Version

The implementation information written to the File Meta Header in each file is:

**Table 5.1-1  
DICOM IMPLEMENTATION CLASS AND VERSION FOR MEDIA STORAGE**

File Meta Information Version	1
Implementation Class UID	1.2.392.200036.9116.39.1.1
Implementation Version Name	MGU1000D_V220

## 5.2 AE SPECIFICATIONS

### 5.2.1 Offline-Media AE Specification

The Offline-Media AE provides standard conformance to the DICOM Interchange Option of the Media Storage Service Class. The Application Profiles and roles are listed below:

**Table 5.2-1  
APPLICATION PROFILES, ACTIVITIES, AND ROLES FOR OFFLINE-MEDIA**

Application Profiles Supported	Real World Activity	Role	SC Option
STD-GEN-CD	Export Image Files	FSC	Interchange

#### 5.2.1.1 File Meta Information for the Application Entity

The Source Application Entity Title included in the File Meta Inform Header is below:

**Table 5.2-2  
FILE META INFORMATION FOR OFFLINE-MEDIA**

Application Entity	Default AE Title
Offline-Media	MGU1000D_MEDIA

#### 5.2.1.2 Real-World Activities

##### 5.2.1.2.1 Activity – Export Image Files

The Offline-Media AE acts as an FSC using the interchange option when requested to export SOP Instances from the local database to a CD-R medium.

##### 5.2.1.2.1.1 Media Storage Application Profiles

The Offline-Media AE supports the STD-GEN-CD Application Profile.



**5.2.1.2.1.2 Options**

The Offline-Media AE supports the SOP Classes and Transfer Syntaxes listed in the table below for the STD-GEN-CD Application Profile as an FSC.

**Table 5.2-3  
IODS, SOP CLASSES AND TRANSFER SYNTAXES FOR OFFLINE-MEDIA**

<b>Information Object Definition</b>	<b>SOP Class UID</b>	<b>Transfer Syntax</b>	<b>Transfer Syntax UID</b>
Media Storage Directory Storage	1.2.840.10008.1.3.10	Explicit VR Little Endian	1.2.840.10008.1.2.1
Digital Mammography Image Storage – For Presentation	1.2.840.10008.5.1.4.1.1.1.2	Explicit VR Little Endian	1.2.840.10008.1.2.1

**5.3 AUGMENTED AND PRIVATE APPLICATION PROFILES**

**5.3.1 Augmented Application Profiles**

Not applicable to this product

**5.3.2 Private Application Profiles**

Not applicable to this product

**5.4 MEDIA CONFIGURATION**

Not applicable to this product

## 6. SUPPORT OF CHARACTER SETS

This product supports the following character sets:

- ISO-IR 6 (default)      ISO646
- ISO-IR 87 (Japanese)      JIS X 0208 (Kanji)

Character set ISO-IR 87 can be set to the tags listed in the Table below;

**Table 6-1**  
**Tag lists for ISO-IR 87**

<b>Attribute Name</b>	<b>Tag</b>	<b>VR</b>
Patient's Name	(0010,0010)	PN
Patient Comments	(0010,4000)	LT
Image Comments	(0020,4000)	LT
Performed Physician's Name	(0008,1050)	PN
Operator's Name	(0008,1070)	PN
Institution Name	(0008,0080)	LO
Institution Address	(0008,0081)	ST

## 7. SECURITY

This product does not support any specific security measures.

It is assumed that the product is used within a secured environment. It is assumed that a secured environment includes at a minimum:

- a. Firewall or router protections to ensure that only approved external hosts have network access to the product.
- b. Firewall or router protections to ensure that the product only has network access to approved external hosts and services.
- c. Any communication with external hosts and services outside the locally secured environment use appropriate secure network channels (e.g. such as a Virtual Private Network (VPN))

Other network security procedures such as automated intrusion detection may be appropriate in some environments. Additional security features may be established by the local security policy and are beyond the scope of this conformance statement.

## 8. ANNEXES

### 8.1 IOD CONTENTS

#### 8.1.1 Created SOP Instances

Table 8.1-1 specifies the attributes of a Digital Mammography Image transmitted by the Storage SCU AE.

The following tables use a number of abbreviations. The abbreviations used in the “Presence of ...” column are:

VNAP	Value Not Always Present (attribute sent zero length if no value is present)
ANAP	Attribute Not Always Present
ALWAYS	Always Present
EMPTY	Attribute is sent without a value

The abbreviations used in the “Source” column:

MWL	the attribute value source is from Modality Worklist
USER	the attribute value source is from User input
AUTO	the attribute value is generated automatically
CONFIG	the attribute value source is a configurable parameter

### 8.1.1.1 Digital Mammography Image IOD

**Table 8.1-1  
IOD OF CREATED DIGITAL MAMMOGRAPHY IMAGE SOP INSTANCES**

<b>IE</b>	<b>Module</b>	<b>Reference</b>	<b>Presence of Module</b>	<b>Usage</b>
Patient	Patient	Table 8.1-2	ALWAYS	M
Study	General Study	Table 8.1-3	ALWAYS	M
	Patient Study	Table 8.1-4	ALWAYS	U
Series	General Series	Table 8.1-5	ALWAYS	M
	DX Series	Table 8.1-6	ALWAYS	M
	Mammography Series	Table 8.1-7	ALWAYS	M
Equipment	General Equipment	Table 8.1-8	ALWAYS	M
Image	General Image	Table 8.1-9	ALWAYS	M
	Image Pixel	Table 8.1-10	ALWAYS	M
	Display Shutter	Table 8.1-11	ANAP	U
	DX Anatomy Imaged	Table 8.1-12	ALWAYS	M
	DX Image	Table 8.1-13	ALWAYS	M
	DX Detector	Table 8.1-14	ALWAYS	M
	X-Ray Collimator	Table 8.1-15	ALWAYS	U
	DX Positioning	Table 8.1-16	ALWAYS	U
	X-Ray Acquisition Dose	Table 8.1-17	ANAP	U
	X-Ray Generation	Table 8.1-18	ALWAYS	U
	X-Ray Filtration	Table 8.1-19	ALWAYS	U
	X-Ray Grid	Table 8.1-20	ALWAYS	U
	Mammography Image	Table 8.1-21	ALWAYS	M
	VOI LUT	Table 8.1-22	ALWAYS	M
	Acquisition Context	Table 8.1-23	ALWAYS	M
	SOP Common	Table 8.1-24	ALWAYS	M
	Private Application	Table 8.1-25	ALWAYS	U
	Overlay Plane	Table 8.1-26	Only if Graphic Annotations are present	C

### 8.1.1.2 Modules

**Table 8.1-2  
PATIENT MODULE OF CREATED SOP INSTANCES**

Attribute Name	Tag	VR	Value	Presence of Value	Source
Patient's Name	(0010,0010)	PN	From Modality Worklist or user input. Maximum 31 characters. Ex.)"TOSHIBA^TARO=="	VNAP	MWL/ USER
Patient ID	(0010,0020)	LO	From Modality Worklist or user input. Maximum 15 characters. Ex.) "00000001"	VNAP	MWL/ USER
Patient's Birth Date	(0010,0030)	DA	Ex.) "20040103"	VNAP	MWL/ USER
Patient's Sex	(0010,0040)	CS	Ex.) "M"	VNAP	MWL/ USER
Other Patient IDs	(0010,1000)	LO		EMPTY	AUTO
Other Patient Names	(0010,1001)	PN		EMPTY	AUTO
Ethnic Group	(0010,2160)	SH		EMPTY	AUTO
Patient Comments	(0010,4000)	LT	Comments of patient.	ANAP	MWL/ USER

**Table 8.1-3  
GENERAL STUDY MODULE OF CREATED SOP INSTANCES**

Attribute Name	Tag	VR	Value	Presence of Value	Source
Study Instance UID	(0020,000D)	UI	Ex.)"1.2.392.200036.9116.1.1.1.1.12005634.20040401105559 "	ALWAYS	MWL/ AUTO
Study Date	(0008,0020)	DA	Ex.) "20040402"	VNAP	AUTO
Study Time	(0008,0030)	TM	Ex.) "105620"	VNAP	AUTO
Referring Physician's Name	(0008,0090)	PN		EMPTY	AUTO
Study ID	(0020,0010)	SH	Ex.) "10"	VNAP	AUTO
Accession Number	(0008,0050)	SH	From Modality Worklist or user input. Maximum 16 characters. Ex.) "123456"	VNAP	MWL/ USER

**Table 8.1-4  
PATIENT STUDY MODULE OF CREATED SOP INSTANCES**

Attribute Name	Tag	VR	Value	Presence of Value	Source
Patient Age	(0010,1010)	AS		VNAP	AUTO
Patient's Size	(0010,1020)	DS		EMPTY	AUTO
Patient's Weight	(0010,1030)	DS		VNAP	MWL

**Table 8.1-5  
GENERAL SERIES MODULE OF CREATED SOP INSTANCES**

Attribute Name	Tag	VR	Value	Presence of Value	Source
Modality	(0008,0060)	CS	"MG"	ALWAYS	AUTO
Series Instance UID	(0020,000E)	UI	Ex.)"1.2.392.200036.9116.1.1.1.1.12005634.20040401105559.1 "	ALWAYS	AUTO
Series Number	(0020,0011)	IS	Ex.) "1 "	VNAP	AUTO
Laterality	(0020,0060)	CS	"L " or "R "	ALWAYS	USER
Series Date	(0008,0021)	DA	Ex.) "20040402"	ALWAYS	AUTO
Series Time	(0008,0031)	TM	Ex.) "105620"	ALWAYS	AUTO
Protocol Name	(0018,1030)	LO		VNAP	NWL/AU TO
Series Description	(0008,103E)	LO		VNAP	NWL/US ER
Operators' Name	(0008,1070)	PN		ALWAYS	USER
Body Part Examined	(0018,0015)	CS	"BREAST"	ALWAYS	AUTO
Performed Procedure Step ID	(0040,0253)	SH		VNAP	MWL
Performed Procedure Step Start Date	(0040,0244)	DA	Ex.) "20040402"	ALWAYS	AUTO
Performed Procedure Step Start Time	(0040,0245)	TM	Ex.) "105620"	ALWAYS	AUTO

**Table 8.1-6  
DX SERIES MODULE OF CREATED DIGITAL MAMMOGRAPHY IMAGE SOP INSTANCES**

Attribute Name	Tag	VR	Value	Presence of Value	Source
Presentation Intent Type	(0008,0068)	CS	"FOR PRESENTATION" or "FOR PROCESSING"	ALWAYS	AUTO

**Table 8.1-7  
MAMMOGRAPHY SERIES MODULE OF CREATED DIGITAL MAMMOGRAPHY IMAGE SOP INSTANCES**

Attribute Name	Tag	VR	Value	Presence of Value	Source
Modality	(0008,0060)	CS	"MG"	ALWAYS	AUTO

**Table 8.1-8  
GENERAL EQUIPMENT MODULE OF CREATED SOP INSTANCES**

Attribute Name	Tag	VR	Value	Presence of Value	Source
Manufacturer	(0008,0070)	LO	"TMM "	ALWAYS	AUTO
Institution Name	(0008,0080)	LO	Ex.) "TOSHIBA HOSP"	VNAP	CONFIG
Institution Address	(0008,0081)	ST		VNAP	CONFIG
Station Name	(0008,1010)	SH	Ex.) "MGU-1000D "	ANAP	CONFIG
Manufacturer's Model Name	(0008,1090)	LO	"MGU-1000D "	VNAP	AUTO
Device Serial Number	(0018,1000)	LO	Ex.) "A0123456"	ALWAYS	AUTO
Software Version	(0018,1020)	LO	Ex.) "V2.10R000"	ALWAYS	AUTO
Date of Last Calibration	(0018,1200)	DA		VNAP	AUTO
Time of Last Calibration	(0018,1201)	TM		VNAP	AUTO
Pixel Padding Value	(0028,0120)	SS		VNAP	AUTO

**Table 8.1-9  
GENERAL IMAGE MODULE OF CREATED SOP INSTANCES**

Attribute Name	Tag	VR	Value	Presence of Value	Source
Instance Number	(0020,0013)	IS	Ex.) "1 "	ALWAYS	AUTO
Content Date	(0008,0023)	DA	Ex.) "20040402"	VNAP	AUTO
Content Time	(0008,0033)	TM	Ex.) "105620"	ALWAYS	AUTO
Acquisition Date	(0008,0022)	DA	Ex.) "20040402"	ALWAYS	AUTO
Acquisition Time	(0008,0032)	TM	Ex.) "105620 "	ALWAYS	AUTO
Image Comments	(0020,4000)	LT		VNAP	USER
Quality Control Image	(0028,0300)	CS		VNAP	AUTO
Burned In Annotation	(0028,0301)	CS	"NO"	ALWAYS	AUTO
Referenced Image Sequence	(0008,1140)	SQ		ANAP	AUTO
> Referenced SOP Class UID	(0008,1150)	UI		ANAP	AUTO
> Referenced SOP Instance UID	(0008,1155)	UI		ANAP	AUTO
Source Image Sequence	(0008,2112)	SQ		ANAP	AUTO
> Referenced SOP Class UID	(0008,1150)	UI		ANAP	AUTO
> Referenced SOP Instance UID	(0008,1155)	UI		ANAP	AUTO
> Spatial Locations Preserved	(0028,135A)	CS		ANAP	AUTO

**Table 8.1-10  
IMAGE PIXEL MODULE OF CREATED SOP INSTANCES**

Attribute Name	Tag	VR	Value	Presence of Value	Source
Samples per Pixel	(0028,0002)	US	1	ALWAYS	AUTO
Photometric Interpretation	(0028,0004)	CS	"MONOCHROME2 " or "MONOCHROME1"	ALWAYS	AUTO
Rows	(0028,0010)	US	2816 or 600	ALWAYS	AUTO
Columns	(0028,0011)	US	2016 or 600	ALWAYS	AUTO
Pixel Aspect Ratio	(0028,0034)	IS	"1\1"	ALWAYS	AUTO
Bits Allocated	(0028,0100)	US	16	ALWAYS	AUTO
Bits Stored	(0028,0101)	US	12, 13 or 14 for Storage, 14 for CD-R	ALWAYS	USER
High Bit	(0028,0102)	US	11, 12 or 13 for Storage, 13 for CD-R	ALWAYS	USER
Pixel Representation	(0028,0103)	US	0	ALWAYS	AUTO
Pixel Data	(7FE0,0010)	OW		ALWAYS	AUTO

**Table 8.1-11  
DISPLAY SHUTTER MODULE OF CREATED SOP INSTANCES**

Attribute Name	Tag	VR	Value	Presence of Value	Source
Shutter Shape	(0018,1600)	CS	"RECTANGULAR " or "POLYGONAL "	ANAP	USER
Shutter Left Vertical Edge	(0018,1602)	IS	Present if Shutter Shape is "RECTANGULAR "	ANAP	USER
Shutter Right Vertical Edge	(0018,1604)	IS	Present if Shutter Shape is "RECTANGULAR "	ANAP	USER
Shutter Upper Horizontal Edge	(0018,1606)	IS	Present if Shutter Shape is "RECTANGULAR "	ANAP	USER
Shutter Lower Horizontal Edge	(0018,1608)	IS	Present if Shutter Shape is "RECTANGULAR "	ANAP	USER
Vertices of the Polygonal Shutter	(0018,1620)	IS	Present if Shutter Shape is "POLYGONAL "	ANAP	USER



Table 8.1-12

**DX ANATOMY IMAGED MODULE OF CREATED DIGITAL MAMMOGRAPHY IMAGE SOP INSTANCES**

Attribute Name	Tag	VR	Value	Presence of Value	Source
Anatomic Region Sequence	(0008,2218)	SQ		ALWAYS	AUTO
>Code Value	(0008,0100)	SH	"T-04000"	ALWAYS	AUTO
>Coding Scheme Designator	(0008,0102)	SH	"SNM3"	ALWAYS	AUTO
>Code Meaning	(0008,0104)	LO	"Breast"	ALWAYS	AUTO

Table 8.1-13

**DX IMAGE MODULE OF CREATED DIGITAL MAMMOGRAPHY IMAGE SOP INSTANCES**

Attribute Name	Tag	VR	Value	Presence of Value	Source
Pixel Intensity Relationship	(0028,1040)	CS	"LOG " or "LIN "	ALWAYS	AUTO
Pixel Intensity Relationship Sign	(0028,1041)	SS	-1 or 1	ALWAYS	AUTO
Rescale Intercept	(0028,1052)	DS	"0 "	ALWAYS	AUTO
Rescale Slope	(0028,1053)	DS	"1 "	ALWAYS	AUTO
Rescale Type	(0028,1054)	LO	"US"	ALWAYS	AUTO
Presentation LUT Shape	(2050,0020)	CS	"IDENTITY" or "INVERSE"	ALWAYS	AUTO
Lossy Image Compression	(0028,2110)	CS	"00"	ALWAYS	AUTO
Acquisition Device Processing	(0018,1400)	LO		EMPTY	AUTO
Acquisition Device Processing Code	(0018,1401)	LO		VNAP	USER
Patient Orientation	(0020,0020)	CS	Ex.) "AIR" Not present for specimen image	ANAP	AUTO

Table 8.1-14

**DX DETECTOR MODULE OF CREATED DIGITAL MAMMOGRAPHY IMAGE SOP INSTANCES**

Attribute Name	Tag	VR	Value	Presence of Value	Source
Detector Type	(0018,7004)	CS	"DIRECT"	ALWAYS	AUTO
Detector ID	(0018,700A)	SH		ALWAYS	AUTO
Date of Last Detector Calibration	(0018,700C)	DA		ALWAYS	AUTO
Time of Last Detector Calibration	(0018,700E)	TM		ALWAYS	AUTO
Field of View Shape	(0018,1147)	CS	"RECTANGLE"	ALWAYS	AUTO
Field of View Dimension(s)	(0018,1149)	IS		ALWAYS	AUTO
Imager Pixel Spacing	(0018,1164)	DS		ALWAYS	AUTO
Pixel Spacing	(0028,0030)	DS		ALWAYS	AUTO

**Table 8.1-15  
X-RAY COLLIMATOR MODULE OF CREATED SOP INSTANCES**

Attribute Name	Tag	VR	Value	Presence of Value	Source
Collimator Shape	(0018,1700)	CS	"RECTANGULAR "	ALWAYS	AUTO
Collimator Left Vertical Edge	(0018,1702)	IS		ALWAYS	AUTO
Collimator Right Vertical Edge	(0018,1704)	IS		ALWAYS	AUTO
Collimator Upper Horizontal Edge	(0018,1706)	IS		ALWAYS	AUTO
Collimator Lower Horizontal Edge	(0018,1708)	IS		ALWAYS	AUTO

**Table 8.1-16  
DX POSITIONING MODULE OF CREATED DIGITAL MAMMOGRAPHY IMAGE SOP INSTANCES**

Attribute Name	Tag	VR	Value	Presence of Value	Source
View Position	(0018,5101)	CS	Ex.) "CC"	ALWAYS	AUTO
Estimated Radiographic Magnification Factor	(0018,1114)	DS		ALWAYS	AUTO
Detector Primary Angle	(0018,1530)	DS		ALWAYS	AUTO
Body Part Thickness	(0018,11A0)	DS		ANAP	AUTO
Compression Force	(0018,11A2)	DS		ALWAYS	AUTO

**Table 8.1-17  
X-RAY ACQUISITION DOSE OF CREATED SOP INSTANCES**

Attribute Name	Tag	VR	Value	Presence of Value	Source
Relative X-Ray Exposure	(0018,1405)	IS		ANAP	AUTO
Entrance Dose in mGy	(0040,8302)	DS		ANAP	AUTO
Distance Source to Entrance	(0040,0306)	DS		ANAP	AUTO
Organ Dose	(0040,0316)	DS		ANAP	AUTO

**Table 8.1-18  
X-RAY GENERATION OF CREATED SOP INSTANCES**

Attribute Name	Tag	VR	Value	Presence of Value	Source
KVP	(0018,0060)	DS		ALWAYS	AUTO
X-Ray Tube Current	(0018,1151)	IS		ALWAYS	AUTO
Exposure Time	(0018,1150)	IS		ALWAYS	AUTO
Exposure	(0018,1152)	IS		ALWAYS	AUTO
Exposure in $\mu$ As	(0018,1153)	IS		ALWAYS	AUTO
Exposure Control Mode	(0018,7060)	CS		ALWAYS	AUTO
Exposure Status	(0018,7064)	CS		ALWAYS	AUTO
Focal Spot(s)	(0018,1190)	DS		ALWAYS	AUTO
Anode Target Material	(0018,1191)	CS		ALWAYS	AUTO

**Table 8.1-19  
X-RAY FILTRATION MODULE OF CREATED SOP INSTANCES**

Attribute Name	Tag	VR	Value	Presence of Value	Source
Filter Type	(0018,1160)	SH	"STRIP "	ALWAYS	AUTO
Filter Material	(0018,7050)	CS		ALWAYS	AUTO

**Table 8.1-20  
X-RAY GRID MODULE OF CREATED SOP INSTANCES**

Attribute Name	Tag	VR	Value	Presence of Value	Source
Grid	(0018,1166)	CS	"RECIPROCATING\FOCUSED"	ALWAYS	AUTO

**Table 8.1-21  
MAMMOGRAPHY IMAGE MODULE OF CREATED DIGITAL MAMMOGRAPHY IMAGE SOP INSTANCES**

Attribute Name	Tag	VR	Value	Presence of Value	Source
Image Type	(0008,0008)	CS	Ex.) "DERIVED\SECONDARY"	ALWAYS	AUTO
Positioner Type	(0018,1508)	CS	"MAMMOGRAPHIC"	ALWAYS	AUTO
Distance Source to Detector	(0018,1110)	DS		ALWAYS	AUTO
Distance Source to Patient	(0018,1111)	DS		ALWAYS	AUTO
Positioner Primary Angle	(0018,1510)	DS		ALWAYS	AUTO
Image Laterality	(0020,0062)	CS	"L " or "R "	ALWAYS	AUTO
Organ Exposed	(0040,0318)	CS	"BREAST"	ALWAYS	AUTO
Partial View	(0028,1350)	CS		ALWAYS	AUTO
View Code Sequence	(0054,0220)	SQ		ALWAYS	AUTO
> Code Value	(0008,0100)	SH	Ex.) "R-10242"	ALWAYS	AUTO
> Coding Scheme Designator	(0008,0102)	SH	"SNM3"	ALWAYS	AUTO
> Code Meaning	(0008,0104)	LO	Ex.) "cranio-caudal"	ALWAYS	AUTO
> View Modifier Code Sequence	(0054,0222)	SQ		VNAP	AUTO
>> Code Value	(0008,0100)	SH	Ex.) "R-102D6"	ANAP	AUTO
>> Coding Scheme Designator	(0008,0102)	SH	"SNM3"	ANAP	AUTO
>> Code Meaning	(0008,0104)	LO	Ex.) "Magnification"	ANAP	AUTO

**Table 8.1-22  
VOI LUT MODULE OF CREATED SOP INSTANCES**

Attribute Name	Tag	VR	Value	Presence of Value	Source
Window Center	(0028,1050)	DS	Ex.) 4096\4096	ALWAYS	USER
Window Width	(0028,1051)	DS	Ex.) 8192\8192	ALWAYS	USER
Window Center & Width Explanation	(0028,1055)	LO	"CURRENT\STANDARD" or "STANDARD"	ALWAYS	AUTO

**Table 8.1-23  
ACQUISITION CONTEXT MODULE OF CREATED SOP INSTANCES**

Attribute Name	Tag	VR	Value	Presence of Value	Source
Acquisition Context Sequence	(0040,0555)	SQ		EMPTY	AUTO

**Table 8.1-24**  
**SOP COMMON MODULE OF CREATED SOP INSTANCES**

Attribute Name	Tag	VR	Value	Presence of Value	Source
SOP Class UID	(0008,0016)	UI	Ex.)"1.2.840.10008.5.1.4.1.1.1 "	ALWAYS	CONFIG
SOP Instance UID	(0008,0018)	UI	Ex.) "1.2.392.200036.9116.1.1.1.1.1200563 4.20040401105559 "	ALWAYS	AUTO
Specific Character Set	(0008,0005)	CS	"\ISO 2022 IR 87"	ALWAYS	AUTO

**Table 8.1-25**  
**PRIVATE APPLICATION OF CREATED DIGITAL MAMMOGRAPHY IMAGE SOP INSTANCES**

Attribute Name	Tag	VR	Value	Presence of Value	Source
Private Creator	(7099,00xx)	LO	"TOSHIBA_MEC_MG3"	ANAP	AUTO
Image Header Information	(7099,xx80)	OW	(Black Box)	ANAP	AUTO
Scan Part	(7099,xx81)	OW	(Black Box)	ANAP	AUTO
Output Information	(7099,xx82)	OW	(Black Box)	ANAP	AUTO
Preset X-Ray Information	(7099,xx83)	OW	(Black Box)	ANAP	AUTO
Preset Focus Information	(7099,xx84)	OW	(Black Box)	ANAP	AUTO
Standard Auto Window Parameter	(7099,xx85)	OW	(Black Box)	ANAP	AUTO
Standard DCF Parameter	(7099,xx86)	OW	(Black Box)	ANAP	AUTO
Standard f-proc Parameter	(7099,xx87)	OW	(Black Box)	ANAP	AUTO
Standard Window Parameter	(7099,xx88)	OW	(Black Box)	ANAP	AUTO
Preset Image Information	(7099,xx89)	OW	(Black Box)	ANAP	AUTO
Preset Original Image Information	(7099,xx8A)	OW	(Black Box)	ANAP	AUTO
Preset Bed Information	(7099,xx8B)	OW	(Black Box)	ANAP	AUTO
Actual X-Ray of Exposure	(7099,xx8C)	OW	(Black Box)	ANAP	AUTO
Actual X-Ray of Pre Exposure	(7099,xx8D)	OW	(Black Box)	ANAP	AUTO
FPD Information	(7099,xx8E)	OW	(Black Box)	ANAP	AUTO
Current Auto Window Parameter	(7099,xx8F)	OW	(Black Box)	ANAP	AUTO
Current DCF Parameter	(7099,xx90)	OW	(Black Box)	ANAP	AUTO
Current f-proc Parameter	(7099,xx91)	OW	(Black Box)	ANAP	AUTO
Current Image Information	(7099,xx92)	OW	(Black Box)	ANAP	AUTO
Current Original Image Information	(7099,xx93)	OW	(Black Box)	ANAP	AUTO
Actual Dose Information	(7099,xx94)	OW	(Black Box)	ANAP	AUTO
Actual Pre Exposure Information	(7099,xx95)	OW	(Black Box)	ANAP	AUTO
Image Edit History	(7099,xx96)	OW	(Black Box)	ANAP	AUTO
Stereotactic Biopsy Information	(7099,xx97)	OW	(Black Box)	ANAP	AUTO
Actual Bed Information	(7099,xx98)	OW	(Black Box)	ANAP	AUTO
Annotation Information	(7099,xx99)	OW	(Black Box)	ANAP	AUTO

**Table 8.1-26  
OVERLAY PLANE MODULE OF CREATED SOP INSTANCES**

Attribute Name	Tag	VR	Value	Presence of Value	Source
Overlay Rows	(6000,0010)	US	Same as Rows (0028,0010)	ANAP	AUTO
Overlay Columns	(6000,0011)	US	Same as Columns (0028,0011)	ANAP	AUTO
Overlay Type	(6000,0040)	CS	"G"	ANAP	AUTO
Overlay Origin	(6000,0050)	SS	1\1	ANAP	AUTO
Overlay Bits Allocated	(6000,0100)	US	1	ANAP	AUTO
Overlay Bit Position	(6000,0102)	US	0	ANAP	AUTO
Overlays – Red	(6000,1201)	US		(Note1)	CONFIG
Overlays – Green	(6000,1202)	US		(Note1)	CONFIG
Overlays - Blue	(6000,1203)	US		(Note1)	CONFIG
Overlay Data	(6000,3000)	OB	(Note2)	ANAP	USER
Overlay Rows	(6002,0010)	US	Same as Rows (0028,0010)	ANAP	AUTO
Overlay Columns	(6002,0011)	US	Same as Columns (0028,0011)	ANAP	AUTO
Overlay Type	(6002,0040)	CS	"G"	ANAP	AUTO
Overlay Origin	(6002,0050)	SS	1\1	ANAP	AUTO
Overlay Bits Allocated	(6002,0100)	US	1	ANAP	AUTO
Overlay Bit Position	(6002,0102)	US	0	ANAP	AUTO
Overlays – Red	(6002,1201)	US		(Note1)	CONFIG
Overlays – Green	(6002,1202)	US		(Note1)	CONFIG
Overlays - Blue	(6002,1203)	US		(Note1)	CONFIG
Overlay Data	(6002,3000)	OB	(Note2)	ANAP	USER

NOTE1: Overlays – Red, Green and Blue (60xx,1201),(60xx,1202) and (60xx,1203) have been already retired, but the STORAGE SCU AE will send these attributes. It is configurable not to send these attributes by using the Service Tool.

NOTE2: The overlay (6000,xxxx) will store actual graphic annotations, and the overlay (6002,xxxx) will store these shadows. It is configurable not to send shadow (6002,xxxx) by using the Service Tool.

### 8.1.2 Usage of Attributes from received IOD's

No SOP Class specific fields are required.

### 8.1.3 Attribute Mapping

The relationships between attributes received via Modality Worklist, stored in acquired images and communicated via MPPS are summarized in Table 8.1-27.

**Table 8.1-27**  
**ATTRIBUTE MAPPING BETWEEN MODALITY WORKLIST, IMAGE AND MPPS**

Modality Worklist	Image IOD	MPPS IOD
Study Instance UID	Study Instance UID	>Study Instance UID
Accession Number	Accession Number	>Accession Number
Requested Procedure ID	--	>Requested Procedure ID
Requested Procedure Code Sequence	Protocol Name	>Protocol Name
Requested Procedure Description	--	>Requested Procedure Description
> Scheduled Procedure Step ID	--	>Scheduled Procedure Step ID
> Scheduled Procedure Step Description	Series Description	>Scheduled Procedure Step Description
> Scheduled Protocol Code Sequence	--	Performed Protocol Code Sequence
> Scheduled Procedure Step ID	--	Performed Procedure Step ID
--	Performed Procedure Step Start Date	Performed Procedure Step Start Date
--	Performed Procedure Step Start Time	Performed Procedure Step Start Time
Patient Name	Patient Name	Patient Name
Patient's ID	Patient's ID	Patient's ID
Patient's Birth Date	Patient's Birth Date	Patient's Birth Date
Patient's Sex	Patient's Sex	Patient's Sex
Patient's Weight	Patient's Weight	--
Patient Comments	Patient Comments	--
--	Operator's Name	Operator's Name

This table shows only typical data sets.

Other data sets are also set as default settings.

All map settings, including the default setting data sets, can be customized.

### 8.1.4 COERCED/MODIFIED FIELDS

Not applicable to this product.

## 8.2 DATA DICTIONARY OF PRIVATE ATTRIBUTES

The Private Attributes added to created SOP Instances are listed in the Table below. This product reserves blocks of private attributes in groups 7099.

**Table 8.2-1**  
**DATA DICTIONARY OF PRIVATE ATTRIBUTE**

Tag	Attribute Name	VR	VM
(7099,00xx)	Private Creator	LO	1
(7099,xx80)	Image Header Information	OW	1
(7099,xx81)	Scan Part	OW	1
(7099,xx82)	Output Information	OW	1
(7099,xx83)	Preset X-Ray Information	OW	1
(7099,xx84)	Preset Focus Information	OW	1
(7099,xx85)	Standard Auto Window Parameter	OW	1
(7099,xx86)	Standard DCF Parameter	OW	1
(7099,xx87)	Standard f-proc Parameter	OW	1
(7099,xx88)	Standard Window Parameter	OW	1
(7099,xx89)	Preset Image Information	OW	1
(7099,xx8A)	Preset Original Image Information	OW	1
(7099,xx8B)	Preset Bed Information	OW	1
(7099,xx8C)	Actual X-Ray of Exposure	OW	1
(7099,xx8D)	Actual X-Ray of Pre Exposure	OW	1
(7099,xx8E)	FPD Information	OW	1
(7099,xx8F)	Current Auto Window Parameter	OW	1
(7099,xx90)	Current DCF Parameter	OW	1
(7099,xx91)	Current f-proc Parameter	OW	1
(7099,xx92)	Current Image Information	OW	1
(7099,xx93)	Current Original Image Information	OW	1
(7099,xx94)	Actual Dose Information	OW	1
(7099,xx95)	Actual Pre Exposure Information	OW	1
(7099,xx96)	Image Edit History	OW	1
(7099,xx97)	Stereotactic Biopsy Information	OW	1
(7099,xx98)	Actual Bed Information	OW	1
(7099,xx99)	Annotation Information	OW	1

### 8.3 CODED TERMINOLOGY AND TEMPLATES

The MWM SCU AE is capable of supporting arbitrary coding schemes for Protocol Codes. The contents of Requested Procedure Code Sequence (0032,1064) and Scheduled Protocol Code Sequence (0040,0008) supplied in Worklist Items will be mapped to Image IOD and MPPS attributes as described in Table 8.1-26. During installation, a service technician will establish a mapping between the site-specific codes and the protocol Name and the acquisition protocols. Table 8.3-1 and Table 8.3-2 provide the default mapping.

**Table 8.3-1  
DEFAULT MAPPING OF PROTOCOL NAME**

<b>Code value of Requested Procedure Code Sequence</b>	<b>Protocol Name (Study type)</b>
MAWF0001	Normal
MAWF0002	
MAWF0003	
MAWF0004	
MAWF0005	
MAWF0006	
MAWF0007	
MAWF0008	
MAWF0009	
MAWF0010	
MAWF0011	
MAWF0012	
MAWF0013	Stereotactic Biopsy-Left
MAWF0015	
MAWF0014	Stereotactic Biopsy-Right
MAWF0016	
MAWF0017	Specimen
MAWF0018	



**Table 8.3-2  
DEFAULT MAPPING OF PROTOCOL CODE**

Code Value of Scheduled Protocol Code Sequence	Acquisition Protocols				
	Technique	Laterality of Breast	View Position		
1000000781L03000	Contact	Left	CC		
1000000781L03100			MLO		
1000000781L00700			ML		
1000000781L02600			ISO		
1000000781L02300			FB		
1000000781L03200			LMO		
1000000781L00800			LM		
1000000781L02800			SIO		
1000000781R03000			Right	CC	
1000000781R03100				MLO	
1000000781R00700		ML			
1000000781R02600		ISO			
1000000781R02300		FB			
1000000781R03200		LMO			
1000000781R00800		LM			
1000000781R02800		SIO			
1000000781L03026		Magnification		Left	CC
1000000781L03126					MLO
1000000781L00726			ML		
1000000781L02626			ISO		
1000000781L02326	FB				
1000000781L03226	LMO				
1000000781L00826	LM				
1000000781L02826	SIO				
1000000781R03026	Right		CC		
1000000781R03126			MLO		
1000000781R00726			ML		
1000000781R02626			ISO		
1000000781R02326			FB		
1000000781R03226			LMO		
1000000781R00826			LM		
1000000781R02826			SIO		
5000000001L000SC			Stereotactic Biopsy	Left	Scout
5000000002L000SL					Stereo L
5000000003L000SR	Stereo R				
6000000001R000SC	Right			Scout	
6000000002R000SL		Stereo L			
6000000003R000SR		Stereo R			
7000000001L00SPC	Specimen	Left	Tissue specimen		
7000000002L00SPC		Right			

#### **8.4 GRAYSCALE IMAGE CONSISTENCY**

Not applicable to this product.

#### **8.5 STANDARD EXTENDED/SPECIALIZED/PRIVATE SOP CLASSES**

Not applicable to this product.

#### **8.6 PRIVATE TRANSFER SYNTAXES**

Not Applicable to this product.